

 **Level Sensors**



Special-Sensors for Automation

Level Sensors

Contents

Technique and application for Level Sensors

Sensors	2.3 - 2.04
Terminology	2.4 - 2.05
Installation and operation	2.06

Level sensors

Level meter Series MFP	2.8 - 2.12
Microwave-compact Series MFC	2.13
Microwave-compact Series Serie MFK	2.14
Capacitive sensors-compact Series KGF / KGMR / KGFR / KFC	2.15 - 2.18
Opto switch-compact Series UFGS / UFS	2.19 - 2.20
Conductive compact model Series CFC	2.21
Hydrostatic level meter Series DGC	2.22
Capacitive analog-sensors up to 200 °C Series KFA	2.23
Capacitive –230 °C-low temperature Series KGFP	2.24
Capacitive 230 °C-high temperature Series KGFT / KGFT-CER	2.25 - 2.26
Capacitive amplifiers Series KK / KU / KUA	2.27 - 2.28

Level Sensors for Ex-applications

Ex-opto sensors Zone 0 Series UFGSa...Ex	2.30
Ex-sensors Zone 0 up to 180 °C Series KGFTa...Ex	2.31
Ex-preamplifier Series KKa 030 Ex	2.32
Ex-amplifier Series IKMb 123 Ex	2.33

Accessories

Mounting sleeves	2.34
M12 connector	2.35
Assembly parts	2.36

We reserve the right to make technical alterations without prior notice.

Level Sensors

Technique & Application

Sensors

Microwave meter

The MFP level meter for continuous monitoring of various liquids allow measurement of the fill level in plastic or metal tanks of any size. The devices offer a high measurement precision. They work with numerous liquids such as water, oil or emulsions.

Principle of measurement: The microwaves are "guided" along the rod – and are reflected at the surface of the medium. From this the sensor determines the fill level. No adjustment is necessary for various media.

The devices are made of aluminium and AISI 316 Ti stainless steel and are suitable for ambient temperatures between –20 and +70 °C. Additional devices are available for monitoring highly corrosive liquids with a coated probe and non-metallic thread.

The fill level meters are available in sizes between 300 and 1200 mm in length. The sensors are equipped with a G3/4 thread and are connected via an M12 plug. The display shows the fill level either in cm or percentage value. You can program additional functions such as a fixed offset value or measuring range.

Microwave level controllers

The microwave level controllers of the MFC and MFK series respond to media contact at the tip of the sensor. They are especially insensitive to soiling and build-up. The devices of the MFK series are made of stainless steel and PTFE and are equipped with a G1/2 process connection. The sensors have a length of 40 mm. Thanks to their integrated electronics, no downstream amplifier is required. The sensors do not have to be adjusted to different media, and for containers made of plastic material, no earth connection is required. Users can adjust the sensitivity of the devices of the MFC series using a pushbutton. Thus, the sensors can distinguish between different layers of liquids (e.g. water and oil) in the containers allowing for an easy separation of liquids. The stainless steel and PTFE

microwave sensors can be used for virtually all container types and sensor environments. They are also suited for use with powder or granules. The sensors are available with a length of between 120 mm and 1000 mm thus offering various different installation options.

Capacitive sensors

The operation of these level sensors is based on a dielectric measuring method. All media which are surround the sensors measuring electrode, built into the tip of the probe, change the state of dielectric balance between the measuring electrode and the surrounding space. This disturbance in the balance triggers a switching command inside the device. The balance can be adjusted with a built-in potentiometer so that materials with different bulk densities and correspondingly different dielectric constants can be measured optimally. Metallic or metal clad vessels should be earthed. In the case of plastic vessels filled with electrically conductive materials, the latter should be earthed. In the case of plastic vessels filled with non-conducting materials, an earthed metal band applied on the outside of the vessel may be used as a counter-electrode.

Medium adjustment for capacitive sensors

Level sensors are set in such a way that they switch upon contact with a medium. The medium adjustment should, if possible, take place without removal under operating conditions. If the built-in part of the sensor can be completely submerged or covered during operation, the adjustment must also take place in this state. If only medium contact is possible, the adjustment takes place upon contact. The trimmer potentiometer is protected by a plastic bolt. This bolt must be removed before the desired sensitivity is set. Turning it clockwise increases the response sensitivity. The adjustment potentiometer is turned until the switch output switches through (normally-open contact). You achieve switching point safety by continuing to turn the potentiometer half a turn to one turn. Devices with a LED line are adjusted to two green LEDs. If the medium adjustment has taken place, the plastic bolt must be fixed again.

Laboratory adjustment

If adjustment cannot be carried out with the sensor mounted in operating position, it can be performed upon a similar vessel. It must, however, be made sure that this vessel is set upon an earthed metal plate, or that the liquid within the vessel is earthed by means of an introduced wire. The minimum height and minimum diameter of the experimental vessel should be about 10 cm.

If setting is correct, the filling level monitor reacts correctly if 50% of the electrode diameter is covered. When mounted vertically, sensors reacts upon contact with the medium. Reaction time lag is less than 0.25 sec.

Level Sensors

Technique & Application

Sensors/ Terminology

Opto-Sensors UF...

Optical sensors react to a change of the refraction index within the proximity of the sensor tip when being immersed into fluid. The sensor does not have to be adjusted. In rare cases, the container wall or particles within the fluid may reflect the light emitted by the sensor and thus interfere with the fluid detection. A trial run is recommended in such instances. The sensors are designed to be used with the respectively listed fluids under normal conditions. The chemical compatibility and technical suitability of the sensor should be tested when used with unlisted fluids.

Resistance UFGS..., UFGSs...Ex	
Water	Monoethylenglycole
Vegetable oil	Glyceric
Diluted acids	Aceton
Diluted bases	Fuels
Ethyl alcohol	Benzol
Methyl alcohol	Diesel
Isopropanol	Motor oil
Isohexan	Hydraulic oil
n-Heptan	Paraffin Oil DAB

Conductive level controller

The CFC 050 GSOP enables level detection of fluids with a conductivity $>10 \mu\text{S/cm}$. Typical applications are dry-running protection or overflow protection in vessel or pipes. The CFC 050 GSOP works with a measuring electrode and a complementary electrode which is connected to the metallic thread. The switching signal is triggered when the fluid has contact to both electrodes.

Adhesions or splash are no problem. Using the screw-on-electrode the CFC 050 GSOP can even be used in plastic container. The electrodes can easily be shortened by the user.

Medium (example)	Conductivity ($\mu\text{S/cm}$)
Concentrated acid or alkaline	up to 1000 000
Industrial contaminated water	up to 500 000
Methylalkohol	440 000
Seawater	55 000
Ethylalkohol	1300
Drinking water	100...2000
Distilled water	0.5...5
Organic or mineral oils	0

Hydrostatic fill level sensor

The hydrostatic fill level sensors of the series DGC 075 are suitable for fill level measuring in liquids and are available for fill levels up to 2000 cm. The measuring range can be adjusted simple and fast by potentiometer and 4 LEDs on the measuring head. It is easy to install with its G3/4 thread, for example in the tank wall, and has protection class IP 67. The sensor has a 4...20 mA signal exit.

Sensors for explosion hazardous areas

Fill level monitors for use in zone 0 are operated with the associated amplifiers listed in the respective connection chart. The analysis devices operated outside of the Ex area. Sensors of the series KGFTa...Ex are used in conjunction with an intermediate amplifier, which is approved for installation in zone 0 or zone 1.

Switching point

Capacitive level sensors react to conductive materials and non-conductive materials with a dielectrical constant $\epsilon > 1.8$. The switching point depends on the material.

In the same installation situation, sensors are more sensitive when using conductive materials.

When the sensor-tip is immersed in a fluid, a switching command inside the device is triggered. This trigger is set between contact with the liquid and some mm more into the liquid. This distance between the tip of the sensor and the trigger is the nominal switching point. The immersion-distance has a negative sign, e. g. -8 mm.

The water content of an object or a liquid has a decisive influence on the switching point. A high humidity content increases the switching point considerably.

Nominal switching point s_p

The switching point or rated operating distance is a device parameter that does not take into account sample variances and external influences such as temperature and supply voltages. Optical sensors are switching by immersing the tip. When the sensor tip is immersed in a fluid, the switching point has a negative sign.

Effective operating distance s_r

The effective operating distance is the operating switching point at nominal voltage and at nominal temperature of 23 °C. It is between 90% and 110% of the rated operating distance.

Usable operating distance s_u

The usable operating point is in the entire allowable temperature and voltage range is between 80% and 120% of the effective operating distance.

Level Sensors

Technique & Application

Terminology

Assured operating distance s_a

The assured operating point takes into account all the external influences, sample and media variations and is in the range from 0% to 72% of the rated operating distance point. Within this range a guaranteed switching is ensured.

Switching point drift

The operating distances are given for an ambient temperature of 23 °C. In the permissible temperature range the switching point varies by less than 15% from the value at 23 °C. The temperature of the measured object has no influence on the switch point.

Hysteresis H

The switching hysteresis describes the distance between the turn on point while immersing in the liquid and the turn off point during the separation of it from the sensor. The hysteresis brings about a stable switching signal even when there are vibrations, temperature drift, or electrical failures.

The hysteresis is defined according to EN 60947-5-2 to be a maximum 20% from the real switching point, and carries a value of typically 10% - 15% from the real switching distance s_r for EGE sensors.

Repeating accuracy R

The repeating accuracy describes the maintenance of the switching point after the repeated immersing in the liquid under specified circumstances. EGE sensors have typical tolerances of less than 3% of the effective operating point.

Switching frequency

The maximum switching frequency of the sensor is determined at nominal switching point S_p when immersing in the water.

Supply voltage

The operating voltage is the voltage range in which EGE sensors function safely. For a constant voltage supply it is important to make sure that the limits are still observed when the residual ripple is included.

Switching current

This current gives the maximum long-term current for the switching output of the sensor at an ambient temperature of 25 °C and ohmic load. At an elevated ambient temperature, the current load capability decreases.

For analog outputs, the boundary values given in the appropriate technical data, and particularly the permissible values for resistance loads, must be observed.

Short circuit protection

The short circuit proof ensures the sensor against destruction through a short circuit on the output. After removal of the fault, the output is reactivated.

Where a maximum overload current is listed, this should not be exceeded.

Overcurrent release

This value indicates the median value of current at which the short circuit protection responds with a tolerance of $\pm 20\%$.

Reverse polarity protection

The reverse polarity protection prevents destruction of the sensor by a reversal of the polarity of the voltage supply.

Voltage drop U_d

The voltage drop arises at the internal resistance of semiconductor elements, which are in the current-path of the output. It is dependent of the load-current and is declared according to EN 60947-5-2 for a mean current of 50 mA.

Residual current I_r

The residual current flows in the load current circuit when the output is blocked. The residual current must be considered when switching sensors in parallel.

Minimum load current I_m

The minimum load current is necessary for flawless operation with two-wire devices.

Current consumption

The current consumption is the maximum value of the no-load current I_0 that the sensor can absorb without a load.

Ambient temperature

The ambient temperature indicates the maximum allowable temperature range for the sensor.

Electromagnetic compatibility EMC

The EMC class is a measure of the noise immunity of the sensor against external electrical and magnetic influences. The information is based on the standard EN 61000-6-2.

Switch-on impulse suppression

EGE sensors have a switch-on impulse suppression that blocks the output during the switch-on phase, when the operational voltage is applied.

Protection

The protective system indicates the protection of the sensors against penetration of foreign bodies and water according to EN 60529.

LED-Display

EGE sensors with yellow light-emitting diodes indicate the switching status optically.

Housing material

The housing material determines the chemical resistance of the sensor against external influences. For special applications, other housing materials are available.

Connection

The connection of the sensors is accomplished through plug-in connections or cables. Different cable types and lengths are available upon request.

Level Sensors

Technique & Application

Installation and operation

Instructions for mounting

The sensor tip of short level sensors installed from the side must be located inside the container. To prevent build-up, it is recommended to install these sensors at a tilted angle of approx. 20°. With rod-style sensors, make sure that the tip is not affected by lateral forces. Such forces may occur, for example, when using sensors near filling openings or mixers. Only use materials for housing and sealing that are suitable for the respective application.

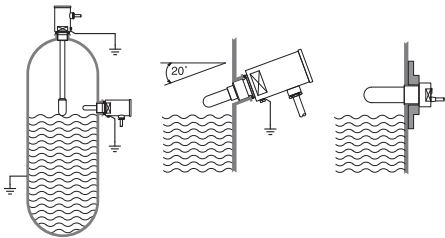

For flush mounting, the sensor can be built into influencing material up to its active surface without changing its characteristics. For non-flush mounting, a metal-free zone around the sensor must be allowed for. A free zone to the material opposite the sensor must be maintained for all sensors.

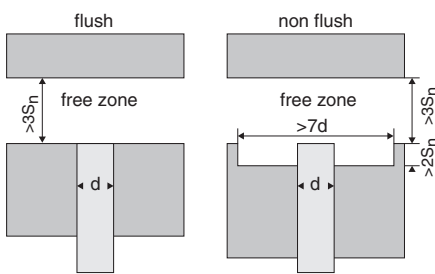

The indicated free zones are in accordance with the standard EN 60947-5-2.

Collocation

When collocating the sensors, a minimum separation must be kept between the devices in order to avoid mutual in-fluence. When in doubt, a test should be conducted under application conditions. For capacitive sensors, the lateral separation from one another must correspond to at least twice the diameter of the sensor. For separations greater than eight times the diameter no mutual influence is to be expected. For oppositely mounted sensors, a minimal separation of eight times the nominal switching separation should be allowed for.

Threads

The threads of the sensors in this prospectus are manufactured to DIN ISO 228-1, tolerance class B. They are designated with (") or (G). If it is necessary to combine different threads, e.g. the sensor-thread made to DIN ISO 228-1 and an inner thread made to DIN ISO 229, such inner thread must be widened by a thread drill.

Torques

In order to prevent destruction of the threaded bushing during fitting, PTFE-sensors may only be tightened by hand.

Sealings

The sealings used for our sensors are made of PTFE, NBR, FPM or AFM. If the temperatures exceed 100 °C or the pressures are higher special sealings are necessary (2). When ordering sensors for such applications, such special sealings must be ordered too.

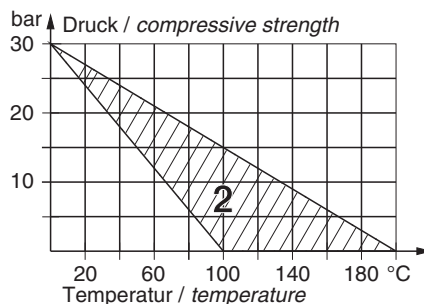

Instructions for operation

Serial connection

For the serial connection of two wire or three wire sensors the individual voltage drops are added together. Therefore there is a lesser operational voltage at the disposal of the load. The addition of the switch-on delay times should be noted.

Parallel connection

The parallel connection of two wire sensors can only be conditionally recommended since the residual currents are added together and flow through the load. For the parallel connection of three wire sensors, the current consumption of the individual devices is added together. Since this current does not flow through the load, the maximum number of parallel connectable three wire sensors depends only on the power supply.

Approval for safety applications

Sensors for personal security must have a qualification approval according to EN 61508 and must be labeled accordingly. Sensors that are not labeled must not be used for applications of this kind.



Probes Compact models Amplifiers





Level meter

Analog output or
2x PNP output

High precision

Water-based liquids

Guided Microwave



Design

DC Analog / DC PNP • G3/4

Dimensions

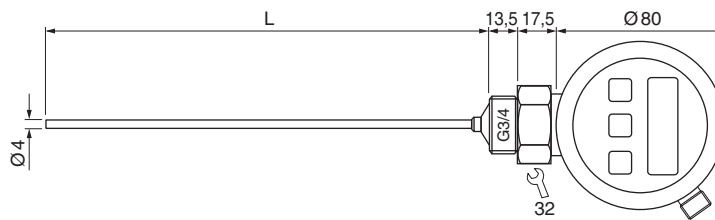

Design	Single probe	Single probe	
Output	4...20 mA, linear 	2x PNP, programmable 	
ID-No.	P.....	P.....	
Type-sensor length L	MFP 075 GA-LMxxx	MFP 075 GPP-LMxxx	Sensor length The total length L of the sensors is specified by appending "xxx" to the type. xxx: Length in cm
Supply voltage [V]	20...27 DC	20...27 DC	
Current consumption [mA]	< 45	< 45	
Current output [mA]	4...20	-	
Load resistance R _L [Ω]	200...500	-	
Switching current [mA]	-	200	
Reverse protection	•	•	
Precision [mm]	5	5	
Transition zone* [mm]	top: 25, bottom: 15	top: 25, bottom: 15	
Ambient temperature [°C]	0...+70	0...+70	
Medium temperature [°C]	0...+80	0...+80	
Sensitivity [ε _r]	≥20	≥20	
Protection [EN 60529]	IP 67	IP 67	
Housing material	Aluminium		
Material	AISI 316 Ti, PTFE		
Sealing material	NBR, AFM 34, different material on request		
Compressive strength [bar]	10 (25 °C)		
Connection	M12 connector		
			Preferred lengths GA
			300 mm: LM030
			500 mm: LM050
			800 mm: LM080
			Preferred lengths GPP
			300 mm: LM030
			500 mm: LM050
			800 mm: LM080
			Note: Installation rules have to be observed.

* Depending on the installation conditions and the medium, deviations from the specified measuring accuracy can occur in this area.

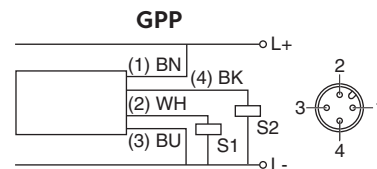
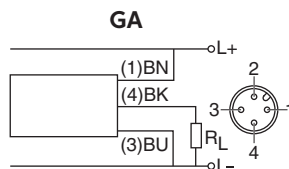

Accessories connecting cable SLG / SLW 3..., SLG / SLW 4..., see page 2.35



Level meter

Analog output or
2x PNP output

High precision

Liquids from oil to water

Guided Microwave



Design DC Analog / DC PNP • G3/4

Dimensions

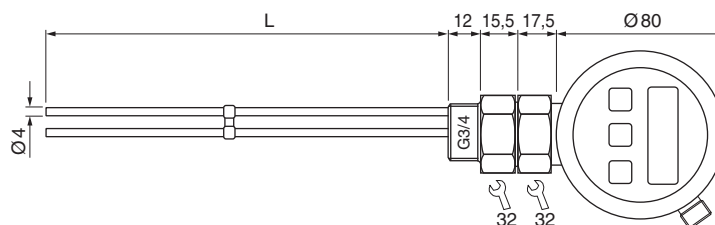

Design	Parallel probe	Parallel probe																	
Output	4...20 mA, linear 	2x PNP, programmable 	<p>Sensor length</p> <p>The total length L of the sensors is specified by appending "xxx" to the type.</p> <p>xxx: Length in cm</p> <table border="0"> <tr> <td>Preferred lengths GA</td> <td>ID-No.</td> </tr> <tr> <td>300 mm: LP030</td> <td>P21202</td> </tr> <tr> <td>500 mm: LP050</td> <td>P21203</td> </tr> <tr> <td>800 mm: LP080</td> <td>P21221</td> </tr> <tr> <td>Preferred lengths GPP</td> <td>ID-No.</td> </tr> <tr> <td>300 mm: LP030</td> <td>P21206</td> </tr> <tr> <td>500 mm: LP050</td> <td>P21207</td> </tr> <tr> <td>800 mm: LP080</td> <td>P21223</td> </tr> </table>	Preferred lengths GA	ID-No.	300 mm: LP030	P21202	500 mm: LP050	P21203	800 mm: LP080	P21221	Preferred lengths GPP	ID-No.	300 mm: LP030	P21206	500 mm: LP050	P21207	800 mm: LP080	P21223
Preferred lengths GA	ID-No.																		
300 mm: LP030	P21202																		
500 mm: LP050	P21203																		
800 mm: LP080	P21221																		
Preferred lengths GPP	ID-No.																		
300 mm: LP030	P21206																		
500 mm: LP050	P21207																		
800 mm: LP080	P21223																		
ID-No.	P.....	P.....																	
Type-sensor length L	MFP 075 GA-LPxxx	MFP 075 GPP-LPxxx																	
Supply voltage [V]	20...27 DC	20...27 DC																	
Current consumption [mA]	< 45	< 45																	
Current output [mA]	4...20	-																	
Load resistance R _L [Ω]	200...500	-																	
Switching current [mA]	-	200																	
Reverse protection	•	•																	
Precision [mm]	5	5																	
Transition zone* [mm]	top: 25, bottom: 25	top: 25, bottom: 25																	
Ambient temperature [°C]	0...+70	0...+70																	
Medium temperature [°C]	0...+80	0...+80																	
Sensitivity [ε _r]	≥2.3	≥2.3																	
Protection [EN 60529]	IP 67	IP 67																	
Housing material	Aluminium																		
Material	AISI 316 Ti, PTFE, POM																		
Sealing material	NBR, AFM 34, different material on request																		
Compressive strength [bar]	10 (25 °C)																		
Connection	M12 connector																		

* Depending on the installation conditions and the medium, deviations from the specified measuring accuracy can occur in this area.

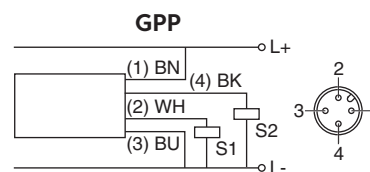
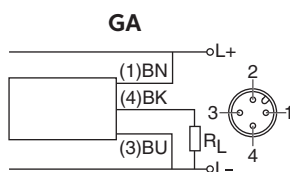

Accessories connecting cable SLG / SLW 3..., SLG / SLW 4..., see page 2.35



Level meter

Analog output or
2x PNP output

High precision
Easy cleaning

Liquids from oil to water

Guided Microwave



Design

DC Analog / DC PNP • G3/4

Dimensions

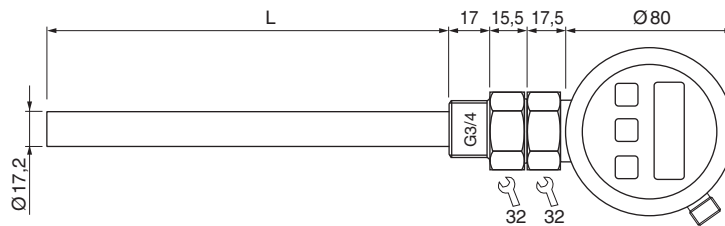

Design	Coaxial probe	Coaxial probe																	
Output	4...20 mA, linear 	2x PNP, programmable 	<p>Sensor length</p> <p>The total length L of the sensor is specified by appending "xxx" to the type.</p> <p>xxx: Length in cm</p> <table border="0"> <tr> <td>Preferred lengths GA</td> <td>ID-No.</td> </tr> <tr> <td>300 mm: LK030</td> <td>P21217</td> </tr> <tr> <td>500 mm: LK050</td> <td>P21218</td> </tr> <tr> <td>800 mm: LK080</td> <td>P21219</td> </tr> <tr> <td>Preferred lengths GPP</td> <td>ID-No.</td> </tr> <tr> <td>300 mm: LK030</td> <td>P21214</td> </tr> <tr> <td>500 mm: LK050</td> <td>P21215</td> </tr> <tr> <td>800 mm: LK080</td> <td>P21216</td> </tr> </table>	Preferred lengths GA	ID-No.	300 mm: LK030	P21217	500 mm: LK050	P21218	800 mm: LK080	P21219	Preferred lengths GPP	ID-No.	300 mm: LK030	P21214	500 mm: LK050	P21215	800 mm: LK080	P21216
Preferred lengths GA	ID-No.																		
300 mm: LK030	P21217																		
500 mm: LK050	P21218																		
800 mm: LK080	P21219																		
Preferred lengths GPP	ID-No.																		
300 mm: LK030	P21214																		
500 mm: LK050	P21215																		
800 mm: LK080	P21216																		
ID-No.	P.....	P.....																	
Type-sensordlength L	MFP 075 GA-LKxxx	MFP 075 GPP-LKxxx																	
Supply voltage [V]	20...27 DC	20...27 DC																	
Current consumption [mA]	< 45	< 45																	
Current output [mA]	4...20	-																	
Load resistance R _L [Ω]	200...500	-																	
Switching current [mA]	-	200																	
Reverse protection [mm]	•	•																	
Precision [mm]	5	5																	
Transition zone* [mm]	top: 25, bottom: 25	top: 25, bottom: 25																	
Ambient temperature [°C]	0...+70	0...+70																	
Medium temperature [°C]	0...+80	0...+80																	
Sensitivity [ε _r]	≥2	≥2																	
Protection [EN 60529]	IP 67	IP 67																	
Housing material	Aluminium																		
Material	AISI 316 Ti, PTFE, POM																		
Sealing material	NBR, AFM 34, different material on request																		
Compressive strength [bar]	10 (25 °C)																		
Connection	M12 connector																		

* Depending on the installation conditions, deviations from the specified measuring accuracy can occur in this area.

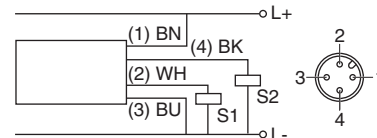
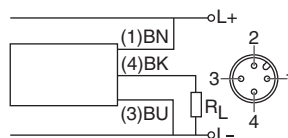

Accessories

connecting cable SLG / SLW 3..., SLG / SLW 4..., see page 2.35



Level meter

Analog output or
2x PNP output

High precision

Probe surface coated
for aggressiv media

Guided Microwave



Design DC Analog / DC PNP • G3/4

Dimensions

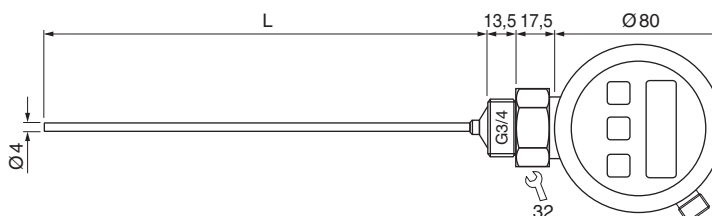

Design	Single probe	Single probe	<p>Sensor length</p> <p>The total length L of the sensors is specified by appending „xxx“ to the type.</p> <p>xxx: Length in cm</p> <p>Preferred lengths single probe ID-No.</p> <p>300 mm: LMF030 P21229</p> <p>500 mm: LMF050 P21230</p> <p>800 mm: LMF080 P21231</p> <p>Preferred lengths single probe ID-No.</p> <p>300 mm: LMF030 P21232</p> <p>500 mm: LMF050 P21233</p> <p>800 mm: LMF080 P21234</p> <p>Note: Different lengths available on request.</p>
Output	4...20 mA, linear 	2x PNP, programmable 	
ID-No.	P....	P....	
Type-sensorlength L	MFP 075 GA-LMFxxx	MFP 075 GPP-LMFxxx	
Supply voltage [V]	20...27 DC	20...27 DC	
Current consumption [mA]	< 45	< 45	
Current output [mA]	4...20	-	
Load resistance R_L [Ω]	200...500	-	
Switching current [mA]	-	200	
Reverse protection [mm]	•	•	
Precision [mm]	5	5	
Transition zone* [mm]	top: 40, bottom: 15	top: 40, bottom: 15	
Ambient temperature [°C]	0...+70	0...+70	
Medium temperature [°C]	0...+80	0...+80	
Sensitivity [ε_r]	≥20	≥20	
Protection [EN 60529]	IP 67	IP 67	
Housing material	Aluminium		
Material	AISI 316 Ti, PTFE, PFA		
Sealing material	NBR, different material on request		
Compressive strength [bar]	10 (25 °C)		
Connection	M12 connector		

* Depending on the installation conditions and the medium, deviations from the specified measuring accuracy can occur in this area.

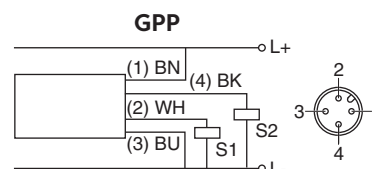
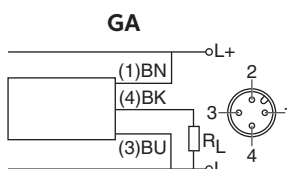

Accessories connecting cable SLG / SLW 3..., SLG / SLW 4..., see page 2.35



Level meter

Analog output or
2x PNP output

High precision

Wetted parts are
non-metallic

Guided Microwave



Design

DC Analog / DC PNP • G3/4

Dimensions

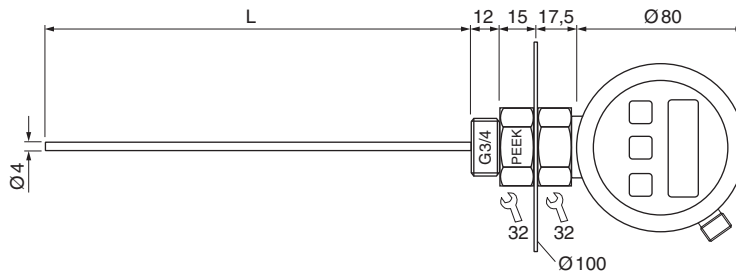

Design	Single probe	Single probe	Sensor length The total length L of the sensors is specified by appending „xxx“ to the type. xxx: Length in cm Preferred lengths single probe ID-No. 300 mm: LMF030 P21235 500 mm: LMF050 P21236 Preferred lengths single probe ID-No. 300 mm: LMF030 P21237 500 mm: LMF050 P21238 Note: Different lengths available on request.
Output	4...20 mA, linear 	2x PNP, programmable 	
ID-No.	P.....	P.....	
Type-sensorenlength L	MFP 075K GA-LMFxxx	MFP 075K GPP-LMFxxx	
Supply voltage [V]	20...27 DC	20...27 DC	
Current consumption [mA]	< 45	< 45	
Current output [mA]	4...20	-	
Load resistance R _L [Ω]	200...500	-	
Switching current [mA]	-	200	
Reverse protection [mm]	•	•	
Precision [mm]	10	10	
Transition zone* [mm]	top: 40, bottom: 15	top: 40, bottom: 15	
Ambient temperature [°C]	0...+70	0...+70	
Medium temperature [°C]	0...+80	0...+80	
Sensitivity [ε _r]	≥20	≥20	
Protection [EN 60529]	IP 67	IP 67	
Housing material	Aluminium, AISI 316 Ti		
Material	PEEK, PFA		
Sealing material	NBR, different material on request		
Compressive strength [bar]	10 (25 °C)		
Connection	M12 connector		

* Depending on the installation conditions and the medium, deviations from the specified measuring accuracy can occur in this area.

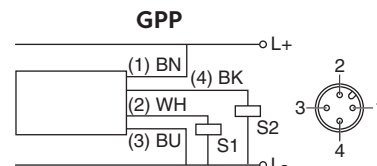
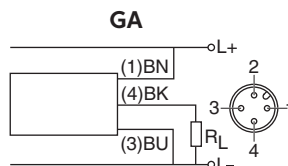

Accessories

connecting cable SLG / SLW 3..., SLG / SLW 4..., see page 2.35



Microwave-compact

G3/4 thread

DC 16...30 V

Sensor length up to 1000 mm



Design **DC PNP • G3/4**

Dimensions

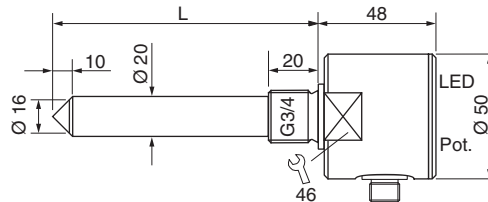

Switching point sp [mm]	-6	
Switching output		
ID-No.	P21188...	<p>Sensor length</p> <p>The total length L of the sensors is specified by appending "Lxxx" to the type.</p> <p>xxx: length in mm</p> <p>Preferred excess lengths ID-No.</p> <p>120 mm: L120 P21188012</p> <p>200 mm: L200 P21188020</p> <p>400 mm: L400 P21188040</p>
Type-sensor length L	MFC 075 GSP-Lxxx	
Supply voltage [V]	16...30 DC	
Switching current [mA]	200	
Short circuit proof	•	
Overcurrent release [mA]	250	
Reverse protection	•	
Voltage drop [V]	2	
Current consumption [mA]	50	
Switching frequency [Hz]	approx. 5	
Ambient temperature [°C]	-20...+85	
Sensitivity* [ε _r]	pre-selectable	
Protection [EN 60529]	IP 67	
LED display	•	
Housing material	AISI 316 Ti / PTFE	
Sealing material	NBR, different materials on request	
Compressive strength [bar]	16 (25 °C)	
Connection	M12 connector	

Adjustment note ε_r:
Remove the protection screw. By pressing the button with the screwdriver provided, you can adjust the sensitivity.

* Sensitivity	
○	green : ε _r ≥ 60
○○	green : ε _r ≥ 25
○○○	green : ε _r ≥ 4
○○○○	green : ε _r ≥ 1.7

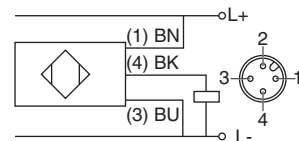

Accessories connecting cable SLG 3..., SLW 3..., see page 2.35



Microwave-compact

G1/2 thread

DC 16...30 V

Sensor length 40 mm



Design

DC PNP • G1/2

Dimensions

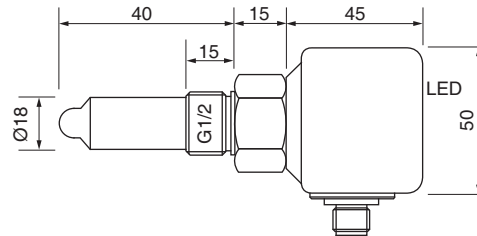

Switching point sp	[mm]	-6
Switching output		
ID-No.		P21193
Type		MFK 50 GSP
Supply voltage	[V]	16...30 DC
Switching current	[mA]	200
Short circuit proof		•
Overcurrent release	[mA]	250
Reverse protection		•
Voltage drop	[V]	2
Current consumption	[mA]	40
Switching frequency	[Hz]	approx. 5
Ambient temperature	[°C]	-20...+85
Sensitivity	[ε _r]	> 10
Protection	[EN 60529]	IP 67
LED display		•
Housing material		PBT / AISI 316 Ti / PTFE
Sealing material		NBR, different materials on request
Compressive strength	[bar]	16 (25 °C)
Connection		M12 connector

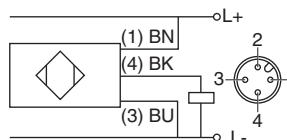

Accessories

connecting cable SLG 3..., SLW 3..., see page 2.35



Capacitive sensor-compact

PTFE housing
M14x1
M30x1.5

DC 10...55 V



Design	DC PNP • M14x1		DC PNP • M30x1.5	
Dimensions				
Switching point sp [mm]	-2		-3	
Switching output				
ID-No.	P20130		P20051	
Type	KGF 014 GSP		KGF 030 GSP	
Supply voltage [V]	10...33 DC		10...55 DC	
Switching current [mA]	200		400	
Short circuit proof	•		•	
Overcurrent release [mA]	800		800	
Reverse protection	•		•	
Voltage drop [V]	1 DC		1 DC	
Minimum load current [mA]	-		-	
Current consumption [mA]	4		4	
Switching frequency [Hz]	10		10	
Ambient temperature [°C]	-25...+75		-25...+75	
EMC-class	A		A	
Protection [EN 60529]	IP 67		IP 67	
LED display	•		•	
Housing material	PTFE		PTFE	
Connection	2 m PVC-cable 3x0.34 mm ²		2 m PVC-cable 0.5 mm ²	
Switching current				
Accessories	fixing nuts are part of delivery			



Capacitive sensor-compact

G3/4 thread

DC 10...55 V



Design	DC PNP • G3/4		DC PNP • G3/4
Dimensions			
Switching point sp	-2		-3
Switching output			
ID-No.	P20055		P21101
Type	KGF 075 GSP		KGMR 107 GSP
Supply voltage [V]	10...55 DC		10...55 DC
Switching current [mA]	400		300
Short circuit proof	•		•
Overcurrent release [mA]	800		800
Reverse protection	•		•
Voltage drop [V]	1 DC		1.5 DC
Minimum load current [mA]	-		-
Current consumption [mA]	4		4
Switching frequency [Hz]	10		10
Ambient temperature [°C]	-25...+75		-25...+75
EMC-class	A		A
Protection [EN 60529]	IP 67		IP 67
LED display	•		•
Housing material	PTFE		PTFE / 1.4571
Sealing material	-		FPM
Connection	2 m PVC-cable 0.5 mm ²		
Switching current			



Capacitive sensor-compact

PTFE housing
G1 thread

DC 10...55 V



Dimensions DC PNP • G1

Dimensions

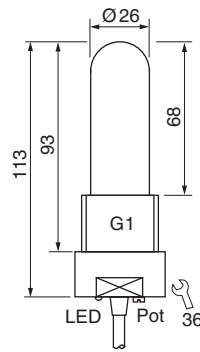

Switching point sp [mm]	-6		-6
Switching output			
ID-No.	P20063		P21198
Type	KGFR 100 GSP		KGFR 100 GSOP
Supply voltage [V]	10...55 DC		10...30 DC
Switching current [mA]	400		200
Short circuit proof	•		•
Overcurrent release [mA]	800		450
Reverse protection	•		•
Voltage drop [V]	1 DC		1.5 DC
Minimum load current [mA]	-		-
Current consumption [mA]	4		10
Switching frequency [Hz]	10		10
Ambient temperature [°C]	-25...+75		-25...+75
EMC-class	A		A
Protection [EN 60529]	IP 67		IP 67
LED display	•		•
Housing material	PTFE		PTFE
Connection	2 m PVC-cable 0.5 mm ²		2 m PVC-cable 0.34 mm ²
Switching current			



Capacitive sensor-compact

G1/2 thread

DC 18...33 V

Stainless steel housing

PTFE-sensor



Design **DC PNP • G1/2**

Dimensions

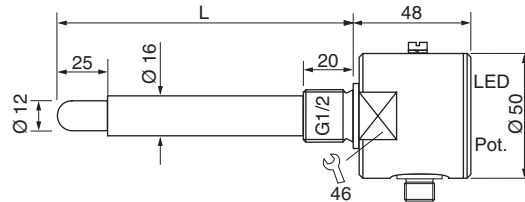

Switching point sp [mm]	-6	-6	-6	-6
Switching output				
ID-No.	P21161	P21162	P21163	P21164
Type-sensor length L	KFC 050 GSP-L50	KFC 050 GSP-L100	KFC 050 GSP-L200	KFC 050 GSP-L400
Supply voltage [V]	18...33 DC			
Switching current [mA]	200			
Short circuit proof	•			
Overcurrent release [mA]	250			
Reverse protection	•			
Voltage drop [V]	2			
Minimum load current [mA]	-			
Current consumption [mA]	10			
Switching frequency [Hz]	5			
Ambient temperature [°C]	housing: -25...+75 / sensor tip: -25...+120			
EMC-class	A			
Protection [EN 60529]	IP 67			
LED display	•			
Housing material	AISI 316 Ti / PTFE			
Sealing material	FFKM (Kalrez)			
Compressive strength [bar]	16 (25 °C)			
Connection	M12 connector			
Switching current				

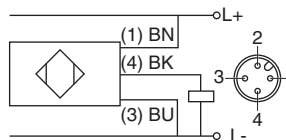
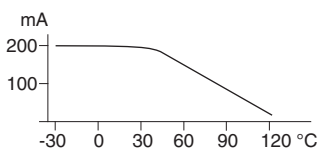

Accessories connecting cable SLG 3..., SLW 3..., see page 2.35



Opto switch-compact

Opto glass-sensor
G3/4 thread

DC 10...33 V

Resistant to detergents
Resistant to hydraulic oil • motor oil



Design **DC PNP • G3/4**

Dimensions

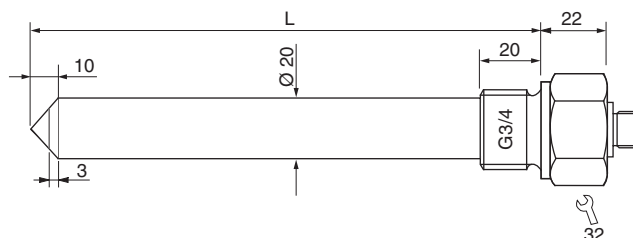

Switching point sp [mm]	- 10	
Switching output		
ID-No.	P21181...	
Type-sensor length L [mm]	UFGS 075 GSOP-Lxxxx	Sensor length
Supply voltage [V]	10...33 DC	The total length L of the sensors is specified by appending "Lxxxx" to the type.
Switching current [mA]	200	xxxx: length in mm
Short circuit proof	•	
Overcurrent release [mA]	250	
Reverse protection	•	
Voltage drop [V]	2	
Minimum load current [mA]	-	
Current consumption [mA]	10	Preferred excess lengths
Switching frequency [Hz]	5	120 mm: L120
Ambient temperature [°C]	-25...+70	200 mm: L200
EMC-class	A	400 mm: L400
Protection [EN 60529]	IP 67	600 mm: L600
LED display	plug with LED	1000 mm: L1000
Housing material	AISI 316 Ti / glass	
Sealing material	FFKM (Kalrez)	
Compressive strength [bar]	16 (25 °C)	
Connection	M12 connector	
Switching current		

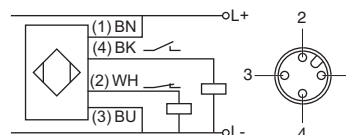
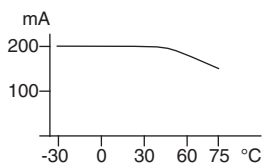

Accessories connecting cable type SLW 4-2 LED (Z01157), see page 2.35



Opto switch-compact

G3/4 thread

DC 10...33 V

Plug connection



Design

DC PNP • G3/4

Dimensions

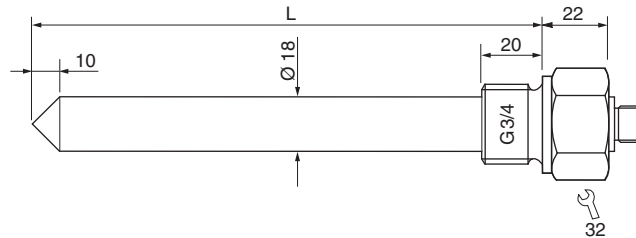

Switching point sp [mm]	-10
Switching output	
ID-No.	P.....
Type-sensor length L [mm]	UFS 075 GSOP-Lxxxx
Supply voltage [V]	10...33 DC
Switching current [mA]	200
Short circuit proof	•
Overcurrent release [mA]	250
Reverse protection	•
Voltage drop [V]	2
Minimum load current [mA]	-
Current consumption [mA]	10
Switching frequency [Hz]	5
Ambient temperature [°C]	-25...+70
EMC-class	A
Protection [EN 60529]	IP 67
LED display	plug with LED
Housing material	AISI 316 Ti / PES
Sealing material	FPM
Compressive strength [bar]	16 (25 °C)
Connection	M12 connector

Sensor length

The total length L of the sensors is specified by appending "Lxxxx" to the type.

xxxx: length in mm

Preferred excess lengths	ID-No.
60 mm: L060	P21209
100 mm: L100	P21121
200 mm: L200	P21122
400 mm: L400	P21123
600 mm: L600	P21124
1000 mm: L1000	P21125

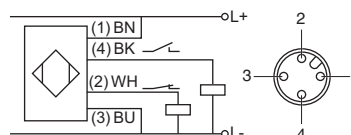
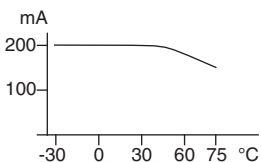

Accessories

connecting cable type SLW 4-2 LED (Z01157), see page 2.35



Conductive compact model

Exact level monitoring of conductive media



Design **DC PNP • G1/2**

Dimensions

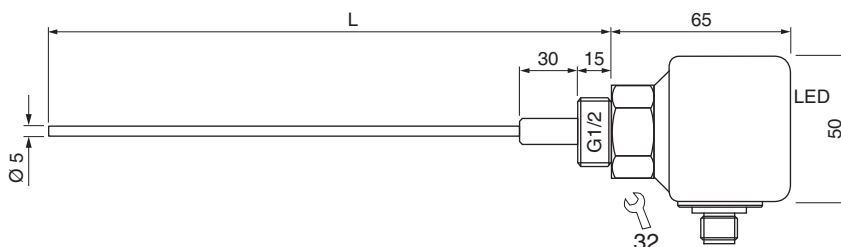

Conductivity	[$\mu\text{S}/\text{cm}$]	> 10 (adjustable)	
Sensor length typ.	[mm]	300 / 500 / 1000*	Sensor length
Switching output			The total length L of the sensors is specified by appending "Lxxxx" to the type.
ID-No.		P.....	xxxx: length in mm
Type-sensor length L	[mm]	CFC 050 GSOP-Lxxxx	Preferred lengths
Supply voltage	[V]	24 DC $\pm 20\%$	300 mm: L300
Switching current	[mA]	100	500 mm: L500
Short circuit proof		•	1000 mm: L1000
Overcurrent release	[mA]	150	ID-No.
Reverse protection		•	300 mm: P21211
Voltage drop	[V]	2,5	500 mm: P21212
Current consumption	[mA]	50	1000 mm: P21213
Ambient temperature	[$^{\circ}\text{C}$]	-20...+60	Notes:
EMC-class		A	Different lengths:
Protection	[EN 60529]	IP 67	Please note in ordering text.
LED display		•	In applications with plastic containers the screw-on-electrode has to be used.
Housing material		AISI 316 Ti / PBT / POM	
Sealing material		EPDM, different material on request	
Compressive strength	[bar]	6 (25 $^{\circ}\text{C}$)	
Connection		M12 connector	

* Cutting to length by user:
See technical manual

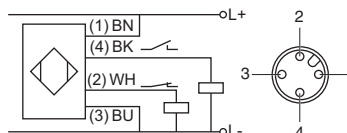

Accessories screw-on-electrode, see page 2.36 / connecting cable SLG 4..., SLW 4..., see page 2.35



Hydrostatic level meter

Analog output



Design

DC • G3/4

Dimensions

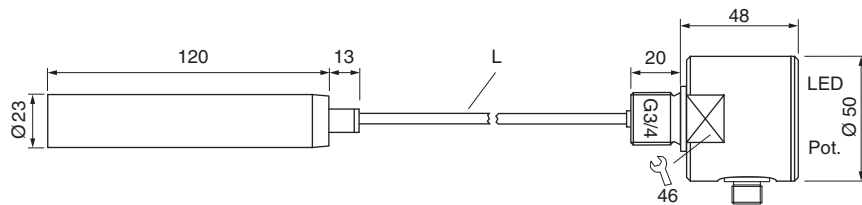

Depth of immersion	[cm]	see sensor length
Output		4...20 mA
ID-No.		P....
Type		DGC 075 GI-Lxxx
Supply voltage	[V]	24 DC ±10%
Load resistance R_L	[Ω]	200...500
Current consumption	[mA]	< 30
Ambient temperature	[°C]	-20...+75
Medium temperature	[°C]	-20...+75
Compressive strength sensor unit	[bar]	2
Material sensor		AISI 316 Ti
Material measuring cell		Ceramic
Material cable sheath		PUR
Sealing material		FPM
Protection	[EN 60529]	housing: IP 65 / probe: IP 68
Connection		M12 connector

Sensor length

The total length L of the sensor is specified by appending "Lxxx" to the type.

xxx: length in cm

Preferred lengths	ID-No.
100 cm: L100	P21224
150 cm: L150	P21225
200 cm: L200	P21226
250 cm: L250	P21227
300 cm: L300	P21228

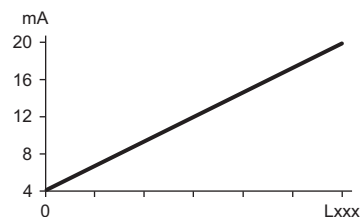
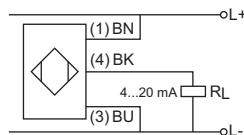
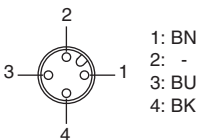

Accessories

connecting cable type SLG 3-2 (Z01076), see page 2.35



Capacitive analog sensor

up to 200 °C

4...20 mA output

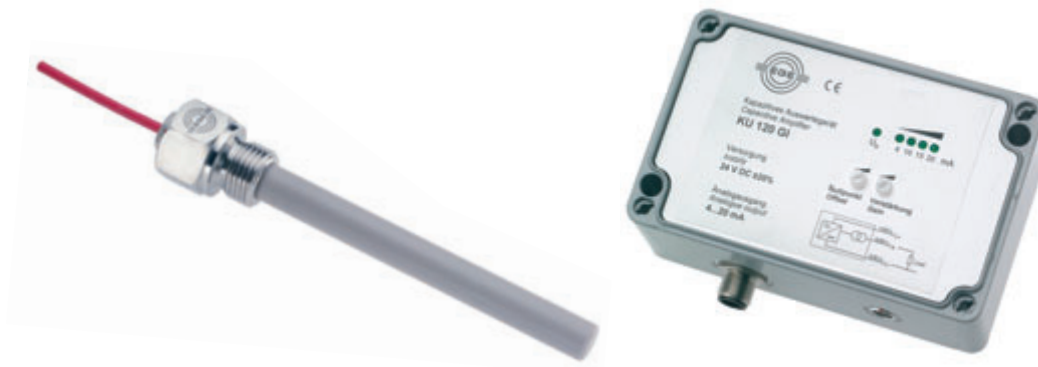

Design	G1/2		KU 120 GI
Dimensions			
Sensing length M [mm]	100	200	
Output	-	-	
ID-No.	P21151	P21152	P21153
Type-sensor length L	KFA 150-L135	KFA 150-L235	KU 120 GI
Supply voltage [V]	-		24 DC ±20%
Current output [mA]	-		4...20
Current consumption [mA]	-		50
Working resistance [Ω]	-		50...400
Reaction frequency [Hz]	2		5
Ambient temperature [°C]	-35...+200		-20...+60
EMC-class	A		A
Protection [EN 60529]	IP 68		IP 65
LEM-connection	IP 54		IP 54
LED display	-		•
Housing material	PEEK / AISI 316 Ti		Aluminium
Sealing material	PTFE		-
Compressive strength [bar]	16		-
Connection	2 m PTFE-cable / LEM 01 plug system		M12 connector
Accessories			connecting cable SLG 3-2, see page 2.35



Capacitive – 230 °C-low temperature

Detection of liquid gases
 Detection of cooled granules

Sensor for connection to an external amplifier



Design	G1/2		KU 125...
Dimensions			
Switching point sp	adjustable	adjustable	adjustable
Switching output			
ID-No.	P21167	P21196	P21166
Type	KGFP 050	KGFP 051	KU 125 GPP
Application area	liquid gases	cooled granules	
Medium temperature [°C]	-230...+80		-
Cable temperature [°C]	-80...+120		-
Supply voltage [V]	-		24 DC ±20%
Current consumption [mA]	-		50
Switching current [mA]	-		400
Hysteresis [%]	-		10 (adjustable)
Switching frequency [Hz]	-		10
Ambient temperature [°C]	-		-20...+60
EMC-class	-		A
Protection [EN 60529]			
housing	IP 68		IP 65
plug	IP 67		IP 67
LED display	-		•
Power on LED	-		•
Housing material	AISI 316 Ti / PTFE		Aluminium
Connection	2 m PTFE-cable with LEM 02 plug system		M12 connector

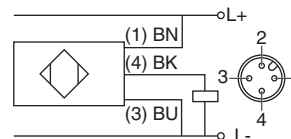

Accessories connecting cable type SLG 3..., SLW 3..., see page 2.35



Capacitive 230 °C-high temperature

Sensor for connection to an external amplifier

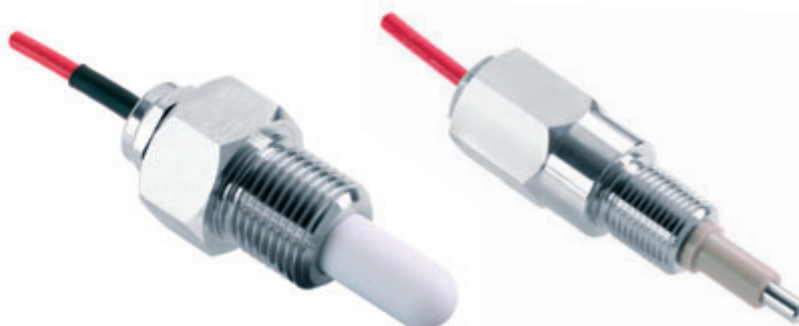

Design	G1/4	G1/2	G1/4	G1/2	G1/4
Dimensions					
Switching point sp [mm]	-6	-6	-6	-6	-6
ID-No.	P21092	P21093	P21119	P21120	P21108
Type	KGFT 025	KGFT 050	KGFT 125	KGFT 150	KGFT 325
Temperature range [°C]	-35...+180	-35...+180	-35...+200	-35...+200	-35...+230
Protection [EN 60529]					
sensor	IP 68	IP 68	IP 68	IP 68	IP 68
plug LEM 01	IP 54	IP 54	IP 54	IP 54	IP 54
Compressive strength [bar]	10	10	30	30	0.5
Housing material	PTFE / AISI 316 Ti	PTFE / AISI 316 Ti	PEEK / AISI 316 Ti	PEEK / AISI 316 Ti	PEEK / AISI 316 Ti
Sealing material	FPM	FPM	PTFE	PTFE	EP
Connection	2 m PTFE-cable with LEM 01 plug system				
	For special applications the seal must be determined separately. In such cases, the combination of pressure and temperature is of great importance (see diagram). Special seals are necessary for applications with media temperatures above +100 °C or where pressures are higher (2).				

If water damp phases cannot be excluded, the KGFT...-CER sensor must be used. (see page 2.26)

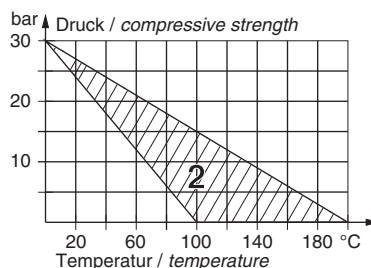

Required amplifiers: KK 030 GSP , KU 120..., KUA 120..., see page 2.27 - 2.28



Capacitive 200 °C-high temperature

Steam proof

Sensor for connection to an external amplifier

30 bar at 140 °C
15 bar at 200 °C



Design	G1/4	KK 030...
Dimensions		
Switching point sp	-6	adjustable
Switching output		
ID-No.	P21199	P21095
Type	KGFT 125-CER	KK 030 GSP
Supply voltage [V]	-	16...55 DC
Current consumption [mA]	-	15
Switching current max. [mA]	-	200
Hysteresis [%]	-	10
Switching frequency [Hz]	-	15
Ambient temperature [°C]	-35...+200	-5...+60
EMC-class	-	A
Protection [EN 60529]	IP 68 (plug LEM 01 IP 54)	IP 67 (plug LEM 01 IP 54)
Compressive strength [bar]	30 at 140 °C / 15 at 200 °C	-
LED display	-	LED yellow
Power on LED	-	LED green
Housing material	AISI 316 Ti / Ceramic	AISI 316 Ti
Sealing material	PTFE	-
Sensor connection	-	LEM 01 plug system
Connection	2 m PTFE-cable with LEM 01 plug system	M12 connector

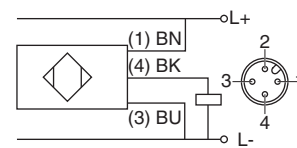
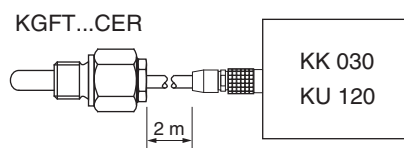
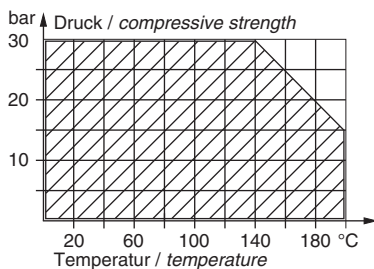

Accessories connecting cable SLG 3..., SLW 3..., see page 2.35



Capacitive amplifiers

For sensors
KGFT up to +230 °C
KGMT up to +200 °C

IP 67 Protection

LED display



Design	KK 030...	KU 120...
Dimensions		
Switching point sp	adjustable	adjustable
Switching output		
ID-No.	P21095	P21107
Type	KK 030 GSP	KU 120 GPP-24
Supply voltage [V]	16...55 DC	24 DC ±20%
Current consumption [mA]	15	50
Switching current max. [mA]	200	400
Hysteresis [%]	10	10 (adjustable)
Switching frequency [Hz]	15	5
Ambient temperature [°C]	-5...+60	-20...+60
EMC-class	A	A
Protection [EN 60529]	IP 67	IP 65
LEM-connection	IP 54	IP 54
LED display	LED yellow	LED-array
Power on LED	LED green	•
Housing material	AISI 316 Ti	Aluminium
Sensor connection	LEM 01 plug	LEM 01 plug
Connection	M12 connector	M12 connector

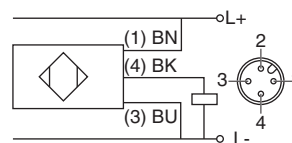

Accessories

connecting cable SLG 3..., SLW 3..., see page 2.35



Probes Amplifiers





Gas- | Intrinsically safe • Zone 0

Opto glass sensor

Gas-Ex Category 1
Ex ia IIC T6 Ga

Resistant in kerosine • motor fuels

3-wire sensor, intrinsically safe



Design	G3/4				
Dimensions					
Switching point sp	[mm]	- 10			
ID-No.	P21239	P21240	P21241	P21242	
Type	UFGSa 075 Ex-L120	UFGSa 075 Ex-L200	UFGSa 075 Ex-L400	UFGSa 075 Ex-L1000	
Sensor length	[mm]	120	200	400	1000
Ex area of use	Gas: Zone 0				
Certificate No.	EPS 18 ATEX 1 097 X		IECEX EPS 18.0054X		
Ex marking	Gas: II 1G Ex ia IIC T6 Ga		Ex ia IIC T6 Ga		
Ambient temperature	[°C]	Gas Zone 0: T6: -20 ≤ Ta ≤ +60 T5: -20 ≤ Ta ≤ +60 T4: -20 ≤ Ta ≤ +60 T3: -20 ≤ Ta ≤ +60		Gas Zone 1: T6: -25 ≤ Ta ≤ +70 T5: -25 ≤ Ta ≤ +75 T4: -25 ≤ Ta ≤ +75 T3: -25 ≤ Ta ≤ +75	
Maximum values	Ui = 12.6 V / li = 80 mA / Pi = 252 mW / Ci = 0.24 nF / Li = 1.3 µH				
Housing material	AISI 316 Ti / glass				
Sealing material	FFKM (Kalrez)				
Tightening torque	[Nm]	100			
Sensitivity	constant for all detectable media				
Protection	[EN 60529]	IP 67			
Compressive strength	[bar]	16			
Connection	M12 connector				
Sensors for the connection to amplifiers IKMb 123 Ex-..., p. 2.33					
Zubehör	plug M12, SBG-DC (Z01060) or SBW-DC (Z00038)				



Ex-Probe | Device category 1G, 1G/2G

Capacitive sensors up to 180 °C

For the connection to KKa 030 Ex

Ex-Device category 1G
Installation in Zone 0 (Gas)

Ex-Device category 1G/2G
Installation in partition wall
Zone 0 / Zone 1 (Gas)



Design	G1/4	G1/2
Dimensions		
Switching point sp [mm]	-8	-8
ID-No.	P21243	P21244
Type	KGFTa 125 Ex	KGFTa 150 Ex
Ex area of use	Gas: Zone 0, Partition wall Zone 0 / Zone 1	
Certificate No.	EPS 19 ATEX 1 263 X	IECEX EPS 19.0116X
Ex marking	Gas: Ex II 1/2 G Ex ia/ib IIC T6...T3 Ga/Gb Ex II 1G Ex ia IIC T6...T3 Ga	Ex ia/ib IIC T6...T3 Ga/Gb Ex ia IIC T6...T3 Ga
Ambient temperature [°C]	Gas Zone 0: T6: -20 ≤ Ta ≤ +80 T5: -20 ≤ Ta ≤ +95 T4: -20 ≤ Ta ≤ +130 T3: -20 ≤ Ta ≤ +180	
Housing material	AISI 316 Ti / PEEK	
Sealing material	PTFE / FKM	
Protection [EN 60529]	Sensor: IP 68 (3 bar) / LEMO plug system: IP 54	
Compressive strength [bar]	medium: 7 / connection: 3	medium: 25 / connection: 3
Connection	2 m PTFE-cable plug system LEMO (series B)	

The Ex-sensors KGFTa...Ex has to be connected exclusively to the Ex-preamplifier KKa 030 Ex (see page 2.32).

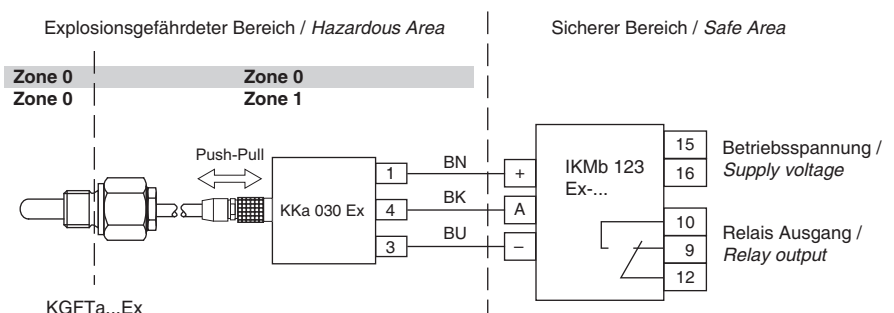

Accessories Ex-preamplifier KKa 030 Ex, p. 2.32 / Ex-amplifier IKMb 123 Ex-..., p. 2.33



Ex-Preamplifier | Device category 1G

For capacitive sensors KGFTa...Ex

Supply by IKMb 123 Ex-...

Ex-Device category 1G
Installation in Zone 0 (Gas)



Design	KKa 030 Ex	
Dimensions		
Sensitivity adjustable	•	
ID-No.	P21245	
Type	KKa 030 Ex	
Ex area of use	Gas: Zone 0	
Certificate No.	EPS 19 ATEX 1 263 X	IECEX EPS 19.0116X
Ex marking	Gas: Ex II 1 G Ex ia IIC T4...T3 Ga Ex II 2(1) G Ex ib [ia Ga] IIC T4...T3 Gb	Ex ia IIC T4...T3 Ga Ex ib [ia Ga] IIC T4...T3 Gb
Ambient temperature [°C]	Gas Zone 0: T4: -20 ≤ Ta ≤ +60 T3: -20 ≤ Ta ≤ +60	
Maximum values	Ui = 9.6 V / li = 50.5 mA / Pi = 121.3 mW / Ci u. Li = negligibly small	
Housing material	AISI 316 Ti	
LED display	•	
Protection [EN 60529]	IP 54	
Connection	LEMO (series B) / M12 connector	
Accessories	required sensors KGFTa... Ex, p. 2.31 and Ex-amplifiers IKMb 123 Ex..., p. 2.33	

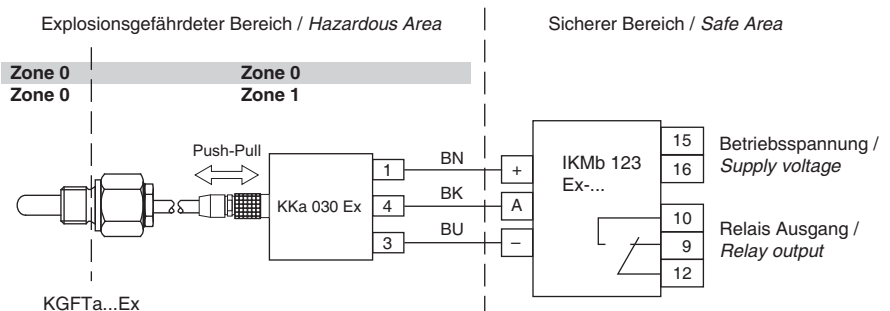
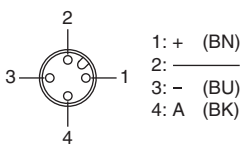



Ex-Amplifiers

Gas [Ex ia Ga] IIC
Dust [Ex ia Da] IIIC

Cable break and
short circuit monitoring

Connection to intrinsically safe
3-lead sensors

Output function programmable



Design IKMb 123 Ex...

Dimensions

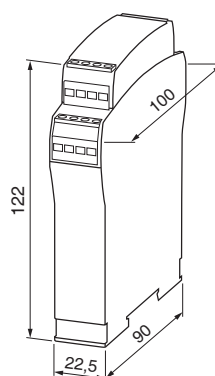

ID-No.	P31451	P31453	P31452
Type	IKMb 123 Ex-24	IKMb 123 Ex-115	IKMb 123 Ex-230
Output	 relay / change over		
Ex area of use	outside of the hazardous areas (gas or dust)		
Certificate No.	EPS 17 ATEX 1 091		IECEX EPS 17.0047
Ex marking	Gas: $\text{Ex II (1)G [Ex ia Ga] IIC}$ Dust: $\text{Ex II (1)D [Ex ia Da] IIIC}$	Gas: [Ex ia Ga] IIC Dust: [Ex ia Da] IIIC	
Ambient temperature [°C]	$-20 \leq T_a \leq +60$		
Maximum values	$U_o = 9.6 \text{ V} / I_o = 50.5 \text{ mA} / P_o = 121.3 \text{ mW} / C_o = 0.68 \mu\text{F} / L_o = 5.00 \text{ mH}$		
Rated voltage [V]	30 DC	127 AC	253 AC
Supply voltage [V]	24 DC $\pm 10\%$	115 AC $\pm 10\%$	230 AC $\pm 10\%$
Switching voltage max. [V]	250 AC / 60 DC / 24 DC		
Switching current max. [A]	4 AC / 0,8 DC / 4 DC		
Switching power	$\cos \varphi > 0,7 / L/R \leq 200 \text{ ms} / L/R \leq 200 \text{ ms}$		
LED display	power: green / switching output: yellow / cable break: red		
Protection [EN 60529]	IP 20		
Connection	terminal screws		

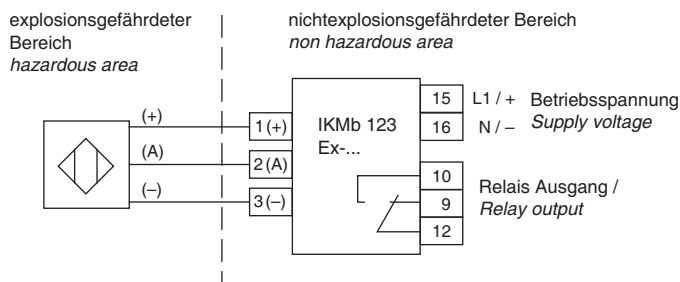



Accessories | Mounting sleeves

It is not necessary to empty the vessel for routine sensor inspection

PTFE housing for high chemical resistance

O-ring moisture barrier



Design	KNM-35	KNM-20	KPM-35
Dimensions			
ID.-No.	P40501	P40500	P40502
Type	KNM-35	KNM-20	KPM-35
Housing material	PTFE	PTFE	Crastin
Torque max. [Nm]	1	1	3
Compressive strength [bar]	3	3	6
Thread	G1 1/4	G3/4	G1 1/2
For sensor type	KNK-025...	KNK-015...	KNK-025...
Usefully sensors	see in our brochure „Capacitive Sensors“		

Fitting in of sleeves and sensors

Mounting sleeves are used for lateral or vertical passage through the vessel side. In order to ensure full pressure resistance, the thread should be screwed into the vessel threaded bush over a length of approximately 20 mm. If this is not possible because the vessel side is too thin, a suitable bush must be installed. However, the threaded passage should not be longer than the thread on the mounting sleeve. The interior thread must comply with DIN ISO 228. Sealing of the thread is either carried out with hemp and a sealing paste according to DIN-DVGW, or with PTFE sealing tape if higher chemical resistance is required. In any case, chemical resistance of the seal must be checked for this application. When screwing in the sleeve, maximum admissible torque must not be exceeded.

Metallic or metal clad vessels should be earthed. In the case of plastic vessels filled with electrically conductive materials, the latter should be earthed. In the case of plastic vessels filled with non-conducting materials, an earthed metal band applied on the outside of the vessel may be used as a counter electrode. For fitting the sensor, the closing ring is unscrewed from the

mounting sleeve. The sensor connecting cable must be fitted through the closing ring and the sensor fitted into the sleeve. After this, the closing ring is screwed back into the mounting sleeve, until the gasket is firmly pressed against the sensor housing. This ensures that no external humidity will penetrate into the mounting sleeve, as this might lead to sensor switching failures.

Sensor compensation

To start with, the plastic screw which protects the compensating potentiometer against humidity must be removed. The screwdriver blade used for compensation should be narrower than 2.4 mm. The sensor is now fitted into the sleeve, and the vessel filled to a level allowing for complete immersion of the sleeve. Beginning at the left limit, turn the potentiometer clockwise until the switching output is operated (NO), after which the potentiometer is turned further clockwise about one revolution. The switching output of the sensor should now be closed. In case of very small bulk densities and corresponding small dielectric constant, it may be necessary to turn only half a revolution.



Accessories | M12 connector

Finished cable plug housing
Self locking screw plug
Protection IP 67

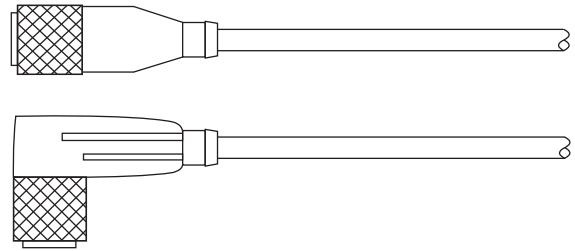

Cable plug housing

straight

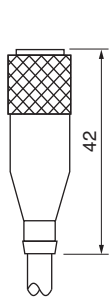

angular

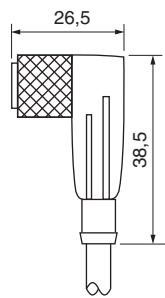

SLG...

SLW...

Pin-assignment

DC

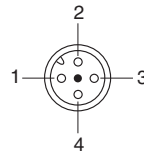

3-wire
1: BN
2: -
3: BU
4: BK

4-wire
1: BN
2: WH
3: BU
4: BK

DC

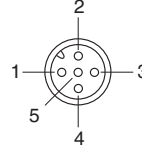

5-wire
1: BN
2: WH
3: BU
4: BK
5: GY

DC

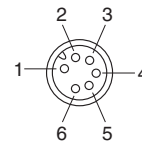

6-wire
1: BN
2: WH
3: BU
4: BK
5: GY
6: PK

DC

TYPE	ID-NO.	DESIGN
SLG 3-2	Z01076	Cable plug housing straight, 2 m cable 3x0.34 mm ² max. 250 V / 4 A
SLG 3-5	Z01077	Cable plug housing straight, 5 m cable 3x0.34 mm ² max. 250 V / 4 A
SLW 3-2	Z01078	Cable plug housing angular, 2 m cable 3x0.34 mm ² max. 250 V / 4 A
SLW 3-5	Z01079	Cable plug housing angular, 5 m cable 3x0.34 mm ² max. 250 V / 4 A
SLW 3-2-LED	Z00052	Cable plug housing angular, 2 m cable 3x0.34 mm ² max. 250 V / 4 A PNP with LED
SLG 4-2	Z00445	Cable plug housing straight, 2 m cable 4x0.25 mm ² max. 250 V / 4 A
SLG 4-5	Z00449	Cable plug housing straight, 5 m cable 4x0.25 mm ² max. 250 V / 4 A
SLW 4-2	Z00446	Cable plug housing angular, 2 m cable 4x0.25 mm ² max. 250 V / 4 A
SLW 4-5	Z00450	Cable plug housing angular, 5 m cable 4x0.25 mm ² max. 250 V / 4 A
SLW 4-2-LED	Z01157	Cable plug housing angular, 2 m cable 4x0.25 mm ² max. 250 V / 4 A PNP with LED
SLG 5-2	Z01150	Cable plug housing straight, 2 m cable 5x0.34 mm ² max. 60 V / 2 A
SLW 5-2	Z01151	Cable plug housing angular, 2 m cable 5x0.34 mm ² max. 60 V / 2 A
SLG 6-2	Z01197	Cable plug housing straight, 2 m cable 6x0.25 mm ² max. 36 V / 2 A
SLW 6-2	Z01198	Cable plug housing angular, 2 m cable 6x0.25 mm ² max. 36 V / 2 A

DATA

Thread	M12x1	Contact resistance	≤ 5 mΩ
Material	PVC	Insulation resistance	>10 ⁹
Protection	IP 67	Testing voltage	2.0 KV eff. / 5 and 6 pol. 1.5 KV eff.
Temperature range	-25...+80 °C		

Note:

The cable plug housings are fitted with a sealing ring and can be used in temperature range of -25 °C...+80 °C. Sensors with DC-NC/NO output (antivalent) are connected to 4-pole cable plug housings (4x0,25 mm²). In this case, the NC output is connected to the white lead (connection 2).



Accessories | Assembly parts

Lock nuts, brass-nickel - plated

ID-NO.	Z00106	Z00107	Z00114	Z00109	Z00110
Nut thickness [mm]	4	4	4	5	5
Thread	M12x1	M18x1	M22x1	M30x1.5	M38x1.5
Spanner size	17	24	27	36	50

Lock nuts, stainless steel

ID-NO.	Z01098	Z00112	Z00113	Z00115
Nut thickness [mm]	4	4	4	5
Thread	M8x1	M12x1	M18x1	M30x1.5
Spanner size	13	17	24	36

Lock nuts, plastics

ID-NO.	Z00180	Z00120	Z00117	Z00118	Z00119	Z01092	Z01052
Nut thickness [mm]	6	8	4	5	5,5	8	8
Thread	M14x1	M30x1.5	M12x1	M18x1	M30x1.5	G 3/4	G 1
Spanner size	22	41	17	24	36	41	50
Material	PTFE	PTFE	PPE	PPE	PPE	PTFE	PTFE

Central screw, polyamide

Z00104	M12, length 70 mm, hexagon socket 10 mm, material PA
Z00105	M16, length 90 mm, hexagon socket 14 mm, material PA

MOUNTING CLAMPS

TYPE	ID-NO.	DIMENSIONS	DESIGN																		
KLS 20 Ø 20 KLS 34 Ø 34	Z00100 Z00102	<p>E: hexagon socket screw 1.4305</p>	Clamps of PA, for smooth-bodied switches <table border="1"> <thead> <tr> <th>F</th> <th>Ø 20</th> <th>Ø 34</th> </tr> </thead> <tbody> <tr> <td>A</td> <td>47</td> <td>61</td> </tr> <tr> <td>B</td> <td>30</td> <td>47</td> </tr> <tr> <td>C</td> <td>17</td> <td>15</td> </tr> <tr> <td>D</td> <td>32</td> <td>45</td> </tr> <tr> <td>E</td> <td>M5x30</td> <td>M5x50</td> </tr> </tbody> </table>	F	Ø 20	Ø 34	A	47	61	B	30	47	C	17	15	D	32	45	E	M5x30	M5x50
F	Ø 20	Ø 34																			
A	47	61																			
B	30	47																			
C	17	15																			
D	32	45																			
E	M5x30	M5x50																			
KLB 35 Ø 35	Z00125	<p>hexagon socket screw 1.4571</p>	Clamp of PTFE (Teflon), for smooth-bodied switches hexagon socket screw M5x40																		
Screw-on-electrode L = 330 mm L = 530 mm L = 1030 mm	Z01205 Z01206 Z01207		Sensor: CFC 050 GSOP Material: AISI 316 Ti For the use in plastic containers																		

Process Sensors

Flow sensors

- Electronical monitoring of flow
- Lubrication monitoring
- Measuring range 1 ml/min...100 l/min
- Detection range 1...300 cm/s
- Reaction time 0.5 s

Ultrasonic sensors

- Switching distance up to 6000 mm
- Level monitoring
- Watertight housing
- Teach-in functions

Pressure sensors

- Monitoring in pipes and containers
- Pressure up to 16 bar
- Level up to 10 m (± 1 cm)
- Compact models
- Programmable

Temperature sensors

- Monitoring in pipes and containers
- Temperature $-40...+120$ °C ($\pm 0,3$ °C)
- Pressure up to 100 bar
- Compact models
- Multi use output NO/NC + analog

Infrared detectors

- Measurement of temperature
- Monitoring of hot media
- Position control

Metal detectors

- Detection of metal parts
- For harsh environment
- Large sensing range up to 400 mm
- Monitoring of bulk materials
- Machine protection



Sales partners, wholesalers and representatives



ARGENTINA, Lomas de Zamora
AUSTRALIA, Warabrook NSW 2304
AUSTRIA, Wien
BELGIUM, Aalst
BRAZIL, Sao Paulo
CANADA, Oldcastle – Ontario
CHINA, Shanghai
COLOMBIA, Bogota D.C.
CZECH REPUBLIC, Ostrava
DENMARK, Aabenraa
ESTONIA, Tallinn
FINLAND, Jyväskylä
FRANCE, Nanteuil les Meaux
GREECE, Sindos - Thessaloniki

GREAT BRITAIN, Staffordshire
HUNGARY, Budapest
INDIA, Mumbai
IRELAND, Clane, Co. Kildare
ISRAEL, Tel-Aviv
ITALY, Carate Brianza (MI)
JAPAN, Tokyo
NAMIBIA, Windhoek
NETHERLANDS, LG Dordrecht
NEW ZEALAND, Greenmount,
Auckland
NORWAY, Kolsås
PHILIPPINES, Taguig City
POLAND, Jezow Sudecki
POLAND, Katowice

RUSSIAN FEDERATION, Moscow
PORTUGAL, Porto
ROMANIA, Bucharest
SINGAPORE, Singapore
SLOVAKIA, Banská Bystrica
SLOVENIA, Ljubljana - Crnuce
SOUTH AFRICA, Cleveland
SOUTH KOREA, Gwangmyeongsi,
Gyeonggi-do
SPAIN, Nigran
SWEDEN, Borås
SWITZERLAND, Uster
TAIWAN, New Taipeh City
TURKEY, Kurtköy / Pendik / Istanbul
USA, Gastonia
VIETNAM, Ho Chi Minh City



<https://ege-elektronik.com/en/organisation/ege/>

We look forward to your enquiry.
Please contact us!

EGE-Elektronik
Spezial-Sensoren GmbH
Ravensberg 34 • 24214 Gettorf • Germany
T +49 (0) 4346-41580 F +49 (0) 4346-5658
info@ege-elektronik.com
ege-elektronik.com

E20323

