

ICL-6100

Features

- 6-channel multiplex amplifier
- Automatic operation for compensation of interference, degradation, and misalignment
- Permanent sensor control
- Test button for diagnosis function
- Analog output 0-10 V DC for testing purposes
- Master-Slave
- Transistor output PNP per channel - short circuit proof
- Transmitter and receiver connections are short circuit proof
- Serial interface (RS232) for PC connection
- Connections are pluggable
- Mounting for DIN rail EN 60715

Short Description

Light barrier amplifiers to be used for the detection of objects in machines or production systems. They form, in conjunction with one infrared transmitter and receiver a powerful light barrier and they are useable in areas with a long range or an extreme degree of pollution in which traditional light barriers reach their limits. The modulation of the infrared light will additionally give the system a high degree of immunity to ambient light, disturbing impulse and influence from other light barriers.

The amplifier ICL-6100... is a compact device which can control six light barriers without mutual influences. An additional amplifier can be synchronized with the Master-Slave connection, to prevent interferences between the light barriers. For a better alignment of the sensor heads the device has an analog output and provides a voltage, which is proportional to the received signal. The highest value represents an optimal adjustment. The amplifier is equipped with an automatic power adjustment, with which the transmit power adjusts to the special environments of the application. To increase the overall accuracy of the device, permanent sensor monitoring was included, which detects errors at the sensor heads and signals this to the user by the alarm output. Included as extra equipment is the integrated test input with which it is possible to make an examination of the light barrier system's functionality. A short circuit proofed switching output reports the light beam status to an evaluation unit, (e.g. a PLC). As a special feature, the device includes a serial interface for easy operation with a PC (Software is optionally available).

Infrared transmitters and receivers in different, compact and robust designs are described in the sensor heads datasheet.

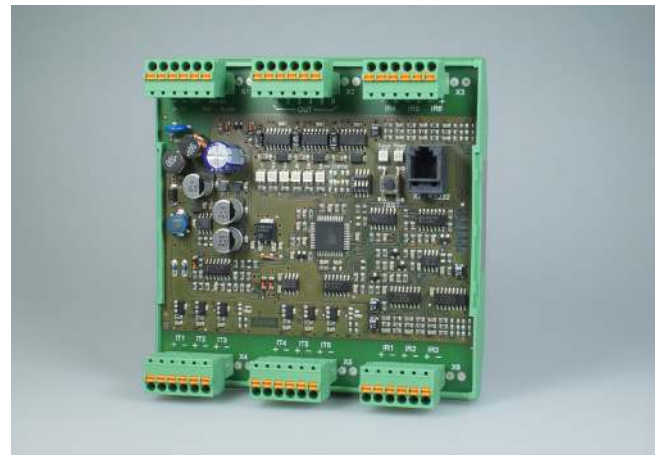

Ordering Table

Type	Order code
Plug with screw terminals	ICL-6100/24VDC
Accessories	Order code
Communication cable	CAB-COM-2m
Power supply 24 V DC	PSU-1000S/95-265VAC
Protective enclosure	PanBox 1x8

Safety Instructions



Warning!

The infrared light barriers ICL-6100 are not safety systems and should not be used as such systems.

The devices are not to be used for applications, where personal safety is dependent on their function.

Device Overview

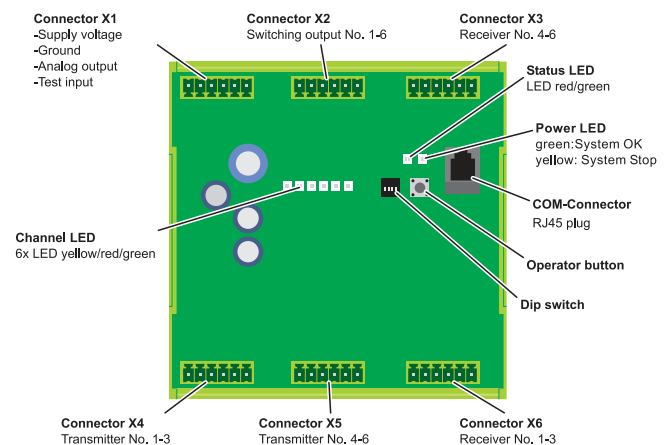

ICL-6100

Technical Data (at 20 °C / 68 °F)

Supply voltage	24 V DC / ± 20% / 4,2 W ¹
Operating basis	modulated IR-light
Transmit frequency	4,0 kHz
Multiplex speed	26 ms
Transmit power	manual / automatic
Basic transmit level (manual)	low / high
Basic transmit level (automatic)	low 1 / low 2 / high 1 / high 2
Switching behavior	light / dark
Master-Slave	yes
Display	
Channel	LED green/yellow/red
Status	LED green/red
Power	LED green/yellow/red
max. Range (through beam)	Receiver IR-..., IRH-...
Transmitter IT-..., ITL-...	15 m (49 ft)
Transmitter IT-...HP, ITH-...	20 m (66 ft)
Transmitter ITA-...	35 m (115 ft)

Switching output	pnp, short circuit proof
max. operation values	100 mA / 24 V DC
reaction time	28 ms ²
Alarm output	pnp, short circuit proof
max. operation values	100 mA / 24 V DC
Analog output	0...10 V DC
Test input	max. 30 V DC / 2 mA
Response voltage	Low < 5 V DC; High > 15 V DC
COM-Interface	RS 232
MTBF (EN/IEC 61709)	113 a (8760 h/a, 40 °C/104 °F)
Housing material	Polyamide
Flammability class (UL94)	V0
Protection class	IP 00
Certifications	CE
Mounting	DIN rail EN 60715
Electrical connection	Phoenix Contact Typ MCV 1,5/6-G-3,81
Operating temperature	-25 ... 50 °C (-13 ... 122 °F)

¹ without loads

² In master/slave mode the total reaction time is the sum of the single reaction times.

Connection Diagram

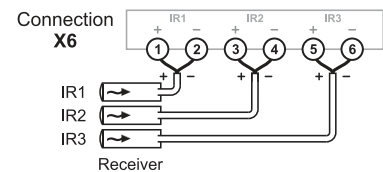
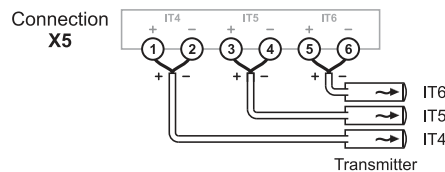
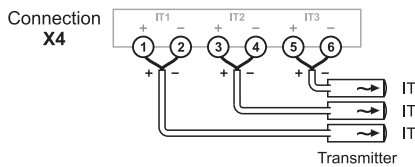
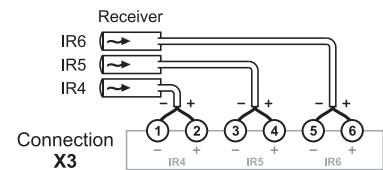
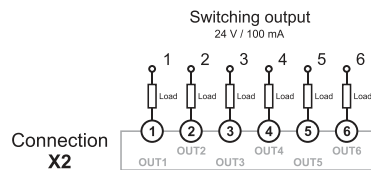
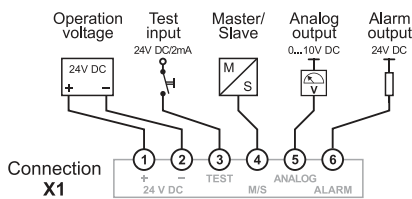

Dimensions (in mm)

