

# CONTRINEX

## HIGHLIGHTS

### SMART SENSORS

- Measure | Monitor | Configure | Predict

### INDUCTIVE WELD-IMMUNE & SPATTER-RESISTANT ACCESSORIES

- Revolutionary protection for long life

### PHOTOELECTRIC FULL-METAL M12 AND M18 SERIES

- Robust with excellent background suppression

### SAFETY LIGHT CURTAINS EXTENDED SLIM

- Wireless configuration via Bluetooth®

### RFID WITH IO-LINK

- Fast data transmission in harsh environments

## GENERAL CATALOG 2021

*new and improved design*

 **IO-Link**

 **Bluetooth®**

 **ContriApp**

  
**SMART SENSOR**

 **WELD-IMMUNE**

**A  
Swiss  
Company**

# INTRODUCTION

## CONTRINEX



*Contrinex Headquarters, Switzerland*

Contrinex is a leading manufacturer of sensors for factory automation. The Swiss company, headquartered in Corminboeuf near Fribourg (CH), has a unique and innovative range of products whose features far surpass those of standard sensors.

Since its foundation in 1972 by Peter Heimlicher, Dipl Ing ETH, Contrinex has grown from a one-man operation to a multinational group with over 580 employees worldwide. More than 13 subsidiaries cover the core markets in Europe, Asia, North and South America.

### AT A GLANCE

- Technology leading manufacturer of inductive and photoelectric sensors as well as safety and RFID systems
- World market leader for miniature sensors, sensors with long operating distances and devices for particularly demanding operating conditions (all-metal, high-pressure and high-temperature resistant sensors)
- Represented in over 60 countries worldwide, headquarters in Switzerland
- 8,000 products

**Technology leader for sensor intelligence and industrial RFID**

## INTELLIGENT SENSORS FOR THE 4<sup>TH</sup> INDUSTRIAL REVOLUTION: INDUSTRY 4.0

### Fit for the future with IO-Link

Intelligent sensors are the fundamental building blocks of modern smart factories. They enable sensor-supported production resources (machines, robots, etc.) to configure, control, manage and optimize themselves. Precise, reliable sensor data is now more essential than ever.

Sensors from Contrinex, the leader in intelligent sensor technology, ensure excellent data quality. To communicate that data, all Contrinex inductive and photoelectric ASIC sensors will be equipped with IO-Link as standard. Customers use either the sensor's binary PNP output or its intelligent IO-Link interface. Both are available in one and the same device. Another advantage is the fact that, with Contrinex sensors, there is no extra charge for IO-Link. This makes them not only quick and simple to install, but also highly economic.

As the first standardized IO technology worldwide (IEC 61131-9) for communication with sensors and actuators, IO-Link is crucial to the 4<sup>th</sup> Industrial Revolution. By installing Contrinex ASIC sensors with IO-Link, users can make themselves fit for the future.

# CUSTOMIZATION

Contrinex has extensive experience in product customization and brand labelling. Over the years, a team of specialists has worked with clients to design, develop and manufacture numerous unique products that meet individual specifications. Custom solutions can range from a very simple adaptation such as a special connector or cable to a new design with special signals, technical characteristics or a customized housing. The company is also equipped to meet branding requirements for product color, packaging, labelling and logos.

Production sites are available worldwide, so products can be manufactured for best availability and in quantities that suit the client's requirements. Quality is assured by vigorous lab testing, pre-shipment inspections and compliance with market standards. All production sites are open to quality audits by clients.

- ✓ Housing shape and size
- ✓ Cable length
- ✓ Embeddable / non-embeddable
- ✓ Threaded / non-threaded
- ✓ Selected technical characteristics

# LIVE SENSOR DATA FOR IoT





### Data monitoring

Switching state is monitored continuously. This not only monitors the signal itself, but also the state at 80% of the switching distance. One can therefore ensure that the sensor is not working at the limit of its specifications.

✓ ✓ ✓ ✓



### Diagnosis

The operating state of the sensor is checked. In case of open circuit, under-voltage, LC oscillator failure or installation of the wrong sensor, information is provided directly through IO-Link to enable fast repair, maintenance and replacement.

✓ ✓ ✓ ✓



### Detection counter

Detection events are counted. By registering the number of detections, it is possible to calculate the speed or number of parts. The counter can be reset by means of a unique IO-Link message.

✓ ✓ ✓



### Temperature

The internal temperature of the sensor is measured continuously, which provides an indication about the ambient temperature in the application. Moreover, the maximum temperature measured is saved for diagnosis and preventive maintenance purposes.

✓ ✓ ✓

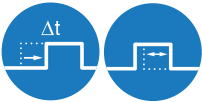

### Switching timer

The timing of output switching can be configured. Depending on the needs of an application, output switching can be delayed or the duration stretched through programming.

✓ ✓ ✓ ✓



### NO/NC selection

The output switching mode can be selected as NO or NC. A single sensor type is configurable for the various needs of an application. This helps reduce the number of different sensor types required in stock.

✓ ✓ ✓



### Sensitivity and teach

The sensitivity of the sensor can be adjusted remotely by changing the threshold. Alternatively, the teach function can be used to adapt the threshold to the application. Calibrated sensing ranges ensure easy sensor replacement by uploading the existing sensitivity to the replacement sensor.

✓ ✓ ✓



### Light-ON/Dark-ON selection

The output switching mode can be selected as Light-ON or Dark-ON. A single sensor type is configurable for the various needs of an application. This helps reduce the number of different sensor types required in stock.

✓



### Sensor mode

Three different modes are selectable depending on the application needs: "Normal", "Fast" and "Fine". "Normal" mode is a good balance of speed and precision. In "Fast" mode, speed is higher and in "Fine" mode precision is higher.

✓ ✓ ✓



### Sequence selection

For cross-talk immunity with through-beam sensors, up to nine different emitting sequences can be selected to pair the emitter with the receiver.

✓

\* Functionalities may vary depending on series and sensor type

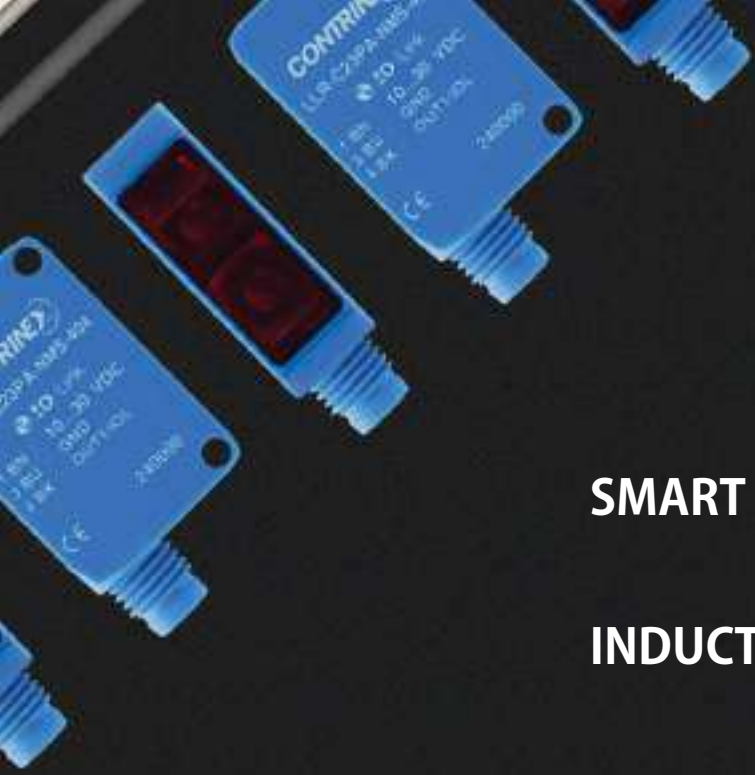

<b>SMART SENSORS</b>	<b>6–25</b>
<b>INDUCTIVE SENSORS</b>	<b>26–117</b>
<b>PHOTOELECTRIC SENSORS / OPTICAL FIBERS</b>	<b>118–199</b>
<b>ULTRASONIC</b>	<b>200–211</b>
<b>SAFETY</b>	<b>212–259</b>
<b>RFID</b>	<b>260–297</b>
<b>ACCESSORIES</b>	<b>298–315</b>
<b>GLOSSARY</b>	<b>316–321</b>

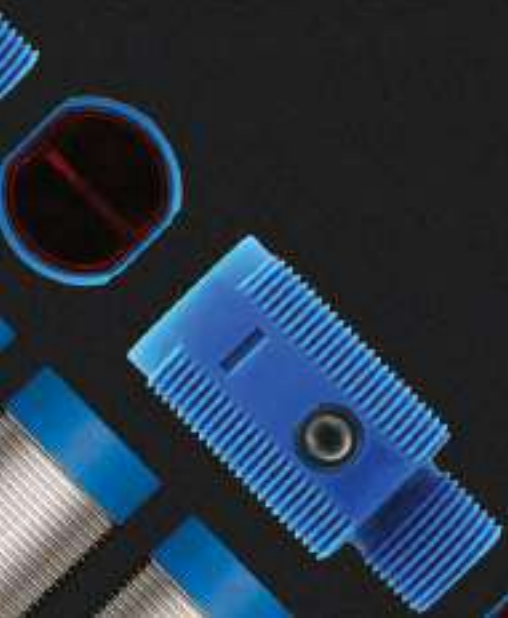





# SMART SENSORS

## HIGHLIGHTS

- ✓ Multiple sensing modes in a single sensor:
  - ✓ Direct measurement: distance measurement, lateral position measurement (constant distance), feature detection
  - ✓ Indirect measurement: Angular measurement, lateral position measurement (inclined plane), force measurement, vibration measurement, step counting
- ✓ Exceptional versatility optimizes spares inventory
- ✓ Condition-based self-monitoring minimizes maintenance costs
- ✓ Localized D2D process logic enables sensor-based decision-making
- ✓ Unique embedded sensor ID eliminates installation errors
- ✓ IO-Link smart profile simplifies control-system integration
- ✓ Full-inox devices offer increased protection in the harshest environments
- ✓ Full-inox versions provide exceptional sensing range on aluminum, brass and copper targets

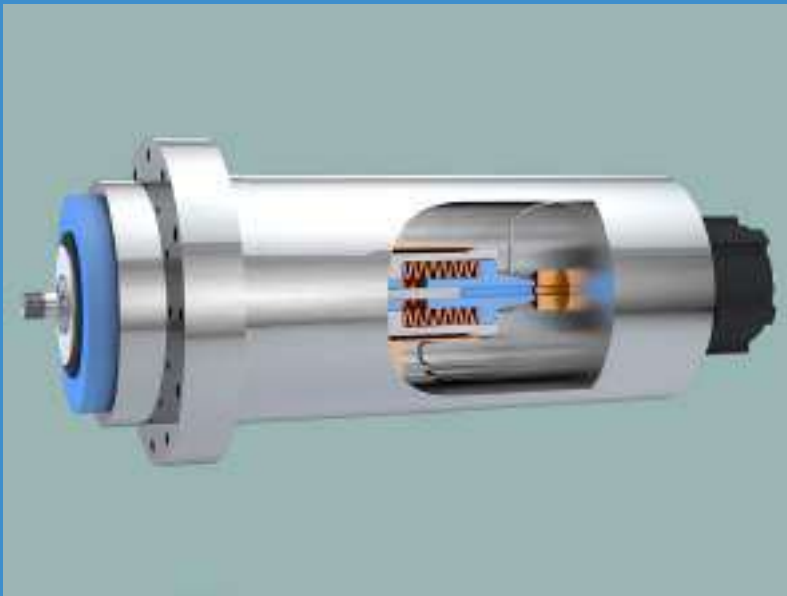

## APPLICATION

### Checking tool presence and position in a confined space

Modern CNC machining centers cope with ranges of materials, workpieces and cutting speeds that require different tool characteristics; spindles with automatic tool-changing are key to optimizing throughput. If a new tool fails to engage completely, damage to the tool, the workpiece or the spindle results. Smart Sensors from Contrinex, embedded in the body of the spindle, monitor the position of the tool during changes; any noncompliant measurements stop the process, triggering an alarm.

## INDUSTRIES

Automation, packaging, robotics, automotive, green energy, environment, logistics, machine tools, electronic assembly, food and beverage, textiles, materials handling



*Spindle-cutting machine tool*



*Metal recycling equipment*



*Conveyor systems*



*Robotics for pick-and-place*



# SMART SENSORS

## MEASURE MONITOR CONFIGURE PREDICT

Contrinex **Smart Sensors**, designed with the needs of OEMs and system integrators in mind, have all the answers when it comes to reducing complexity and cost. By implementing multiple sensing modes in a single sensor, Contrinex has given designers the freedom they have always dreamed about, offering exceptional versatility and simplified integration.

### KEY ADVANTAGES



✓ High-Resolution Measurement

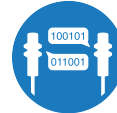

✓ Direct Device-to-Device Communication



✓ User-Configurable Outputs

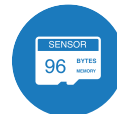

✓ User-Defined Memory



✓ Embedded Predictive-Maintenance Features



✓ Dual Channel



### PRODUCT OVERVIEW

IO-Link		M8	M12	M18
Housing size mm				
s <sub>n</sub> mm	Extra Distance	0 ... 6	0 ... 10	0 ... 20
	Full Inox	-	0 ... 6	0 ... 10

### ACCESSORIES

Go to pages 22 and 298 to see all the accessories

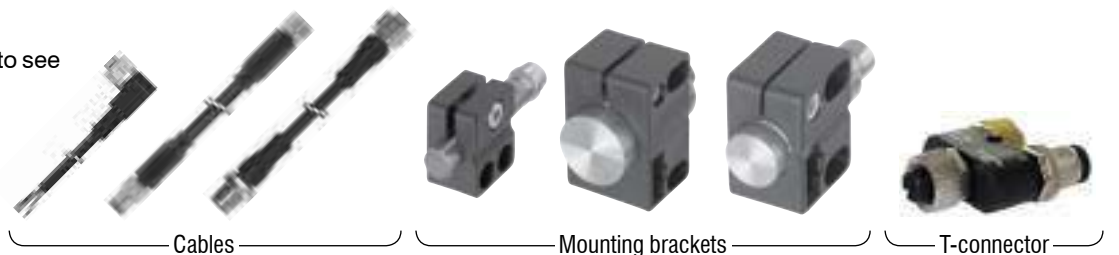

Cables

Mounting brackets

T-connector



## MULTI-MODE HIGH-RESOLUTION MEASUREMENT

- ✓ **Multiple sensing modes in a single sensor**

### DIRECT AND INDIRECT MEASUREMENT

By adopting both direct and indirect measurement techniques, Contrinex has implemented multiple sensing modes in a single Smart Sensor. Depending on the user-defined mode of operation, measurements may be output as either process data (routine, cyclical parametric values) or event data (exceptions generated on the occurrence of a critical event).

Using the Smart Sensor's underlying capability for high-resolution distance measurement, direct measurements include axial distance (1) and lateral position (2). The sensor's exceptional sensitivity also allows it to detect non-uniform features (for example, holes) present in a target (4).

Other physical properties whose application can be translated into a displacement are also suitable for Smart Sensing. Non-contact examples include: continuous angular measurement using a cam mounted on a rotating shaft (3), lateral position measurements of larger targets using an inclined plane surface on the target (5), force measurement using a transfer element that deforms elastically (6), as well as vibration measurement (amplitude and frequency) in the axial direction (7).

Step counting – either linear or rotational (8) – is another proven application for Smart Sensors. The sensitivity of these devices allows them to replace traditional encoders, which are often bulkier and more costly.

#### 1. Distance measurement

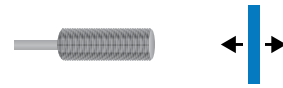

#### 2. Lateral position measurement (constant distance)

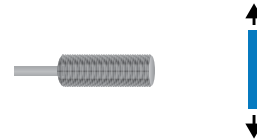

#### 3. Angular measurement

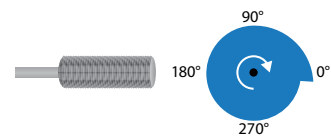

#### 4. Feature detection

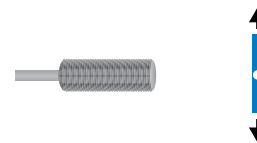

#### 5. Lateral position measurement (inclined plane)

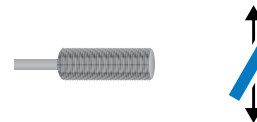

#### 6. Force measurement

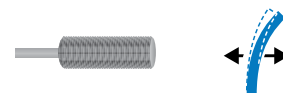

#### 7. Vibration measurement

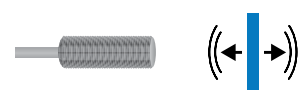

#### 8. Step counting

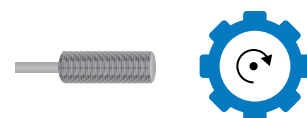



# USER CONFIGURABLE OUTPUTS

✓ **Exceptional versatility optimizes spares inventory**

## SWITCHING SIGNAL CHANNELS (SSC)

The Smart Sensor's internal signals are referred to as Switching Signal Channels (SSC); the external input and output signals that result from an SSC are designated Output Switching Signals (OSS). By default, a Smart Sensor has a single-point threshold SSC enabled on Pin 4 (OSS1) of its connector, which operates in either IO-Link mode or Standard-IO (SIO) mode. On power-up, a Smart Sensor defaults to SIO mode; once the sensor is connected to an IO-Link master, a "wake-up" pulse from the master switches it to IO-Link mode. Thereafter, bidirectional communication operates between the master and the sensor.

### PIN ASSIGNMENT

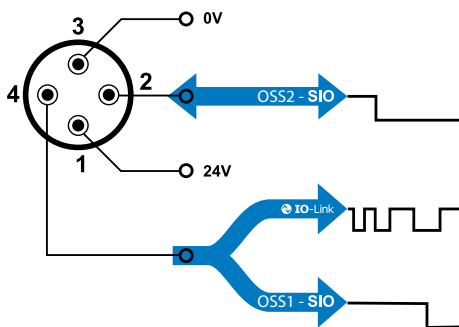

A second SSC may optionally be configured on Pin 2 (OSS2) of the Smart Sensor connector. If enabled, SSC2 operates solely in SIO mode and may be designated as an input or an output channel. The presence of a second IO channel gives integrators access to powerful additional features of the Smart Sensor, including Device-to-Device communication, Teach functions and Built-in Test functions.

## DYNAMIC SWITCHING LOGIC

When specifying Contrinex Smart Sensors, designers assign their chosen switching logic to any of the available sensing modes – either as a one-time choice at the time of installation, or dynamically as the equipment operating sequence dictates. A single sensor provides all the options needed to monitor multiple parameters, with the flexibility to make real-time changes over IO-Link or via the built-in Teach function.

### SINGLE-POINT MODE

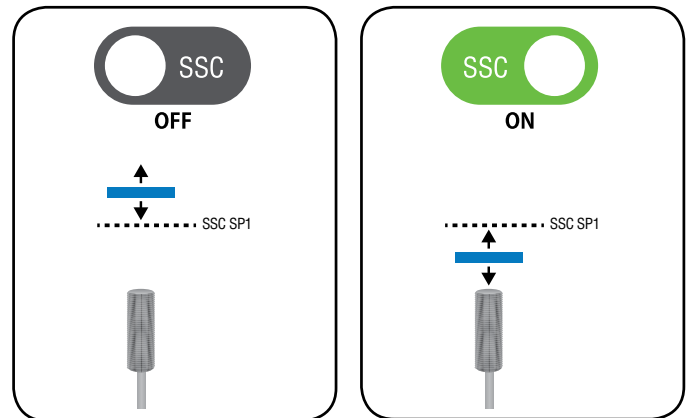

With single-point mode selected, Smart Sensors behave as conventional two-state devices. The default logic (which may be inverted if the application requires it) sets the switching signal to "high" (SSC ON), if a threshold level or setpoint (target sensing distance, for example) has been reached. Either side of the switching point, the signal simply switches between "high" and "low" accordingly.

# SMART SENSORS SMART FEATURES

## WINDOW MODE

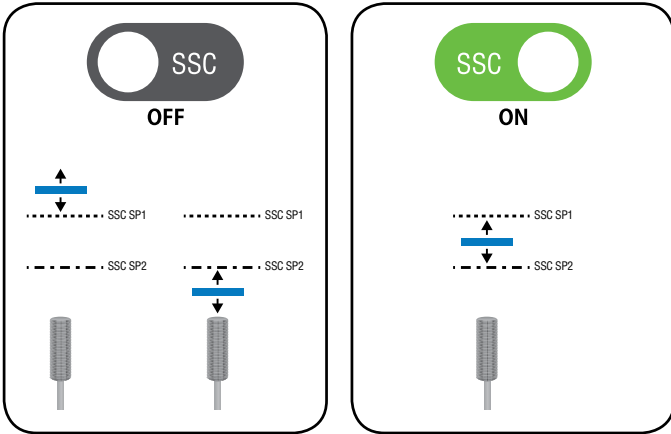

Window mode allows designers to monitor a range of values, which may be defined by two discrete switching setpoints. As the example shows, the default logic sets the switching signal to “high” (SSC ON) if the measured value lies between the two setpoints. In all other cases, once the measured value moves outside the defined range, the switching signal is set to “low”.

## TWO-POINT (HYSTERESIS) MODE

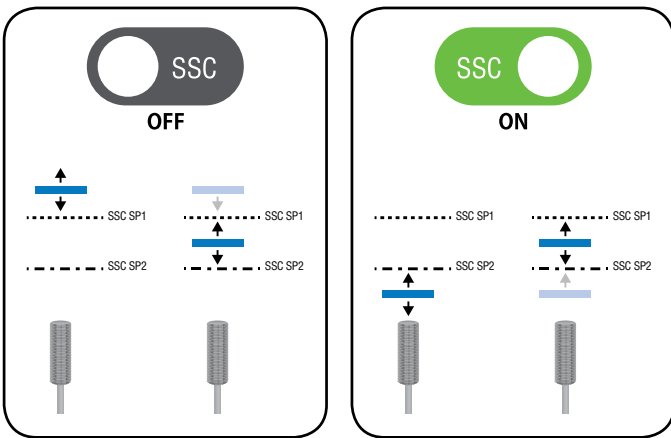

Two-point (hysteresis) mode showcases the Smart Sensor’s ability to respond to setpoints or threshold values that trigger a change in the SSC only when the measured value is moving in a specified direction (rising or falling). In the example shown, as the measured value falls and passes SP1, the SSC remains set to “low” (SSC OFF). Only when the measured value reaches SP2 is the SSC set to “high”. As the measured value rises again, passing SP2 has no effect on the SSC, which is only set to “low” once the measured value reaches SP1 again.

## TIMING MODES

Modifying the timing of a change in the SSC allows designers to nullify the effect of common process events that give rise to false triggers. Such events include (i) momentary changes in measurement value for non-process-related reasons and (ii) momentary loss of signal for known reasons.

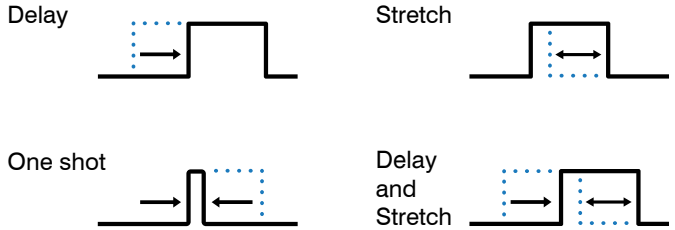

### DELAY

Introducing a specified delay before changing the status of the OSS in either direction prevents the sensor responding to a short-duration change in measurement value for reasons that include localized variability in the environment. Adopting a switching delay also helps prevent signal “bounce”, where the transition from one state to another may not be clearly defined. Delay may optionally be combined with stretch (see below).

### STRETCH

Stretching the OSS pulse ensures that the signal has a minimum duration – often desirable for control purposes or to compensate for a measurement value that varies non-linearly over time. For example, communication with a “slow” PLC may require a minimum-duration pulse to ensure proper synchronization. Similarly, in the absence of a minimum-duration pulse, a measurement value that is not clearly defined during the transition from one state to another might otherwise give rise to multiple false triggers.

### ONE-SHOT MODE

Smart Sensors also have the capability to generate a “one-shot” pulse on either the leading edge or the trailing edge of a change in the measurement value. One-shot pulses, also known as “differential up” and “differential down” may be required for secondary control functions that are implemented in a connected PLC.

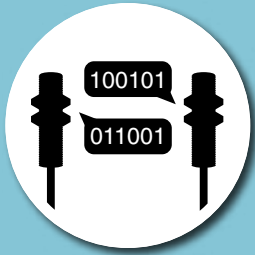

## DIRECT DEVICE-TO-DEVICE COMMUNICATION

✓ Localized D2D process logic enables sensor-based decision-making

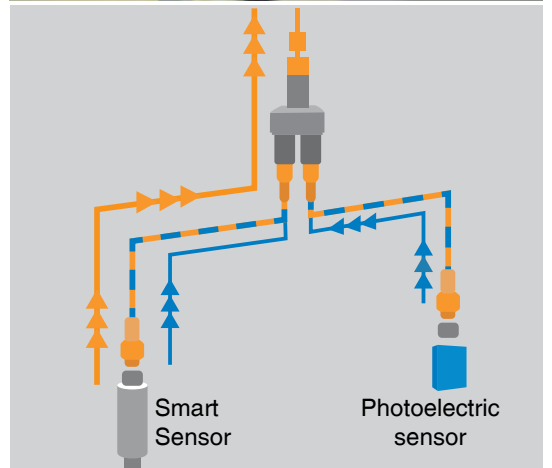

## BOOLEAN LOGIC

Designating a second SSC as an input channel allows designers to implement Boolean logic by combining an internal switching signal of the Smart Sensor (SSC1) together with that of a second two-state sensor (OSS2) operating in SIO mode. In the example shown, the Smart Sensor monitors the presence of an aluminum-foil closure on a bottle, while the secondary photoelectric sensor checks the fill level.

### BOOLEAN AND (sensor enable/disable on pin 2)

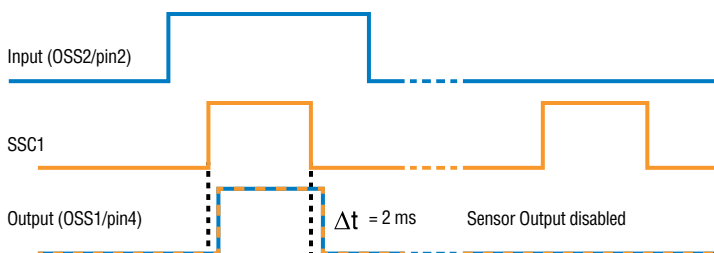

### BOOLEAN "AND"

Operating in Boolean "AND" mode, the signal from the secondary sensor is used to enable or disable the Smart Sensor, resulting in the Smart Sensor output (OSS1) being set to "high" only when both sensors are triggered. The output signal on OSS1 is delayed by two microseconds.

### BOOLEAN OR (sensor bypass on pin 2)

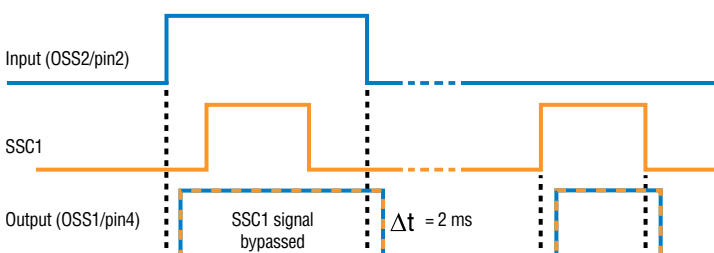

### BOOLEAN "OR"

Alternatively, when a Boolean "OR" function is required, a "high" signal from the secondary sensor is set to bypass the Smart Sensor signal, overwriting the SSC1 output. The Smart Sensor otherwise continues to operate normally, and consequently, its output (OSS1) is set to "high" when either sensor is triggered. Again, a two-microsecond delay is introduced.

## BUILT-IN TEST (BITE) FUNCTION

The SSC2 input channel serves an additional purpose when a self-test function is required. A BITE signal on SSC2 from a connected PLC or microcontroller is used (i) to determine whether the Smart Sensor is functioning correctly and (ii) to establish the presence or absence of a target.

A BITE handshake pulse returned by the sensor confirms its working state, while the polarity of the pulse indicates the presence or absence of a target. Failure by the sensor to return a handshake pulse signifies a defective device.

### BOOLEAN XOR (BITE function on pin 2)

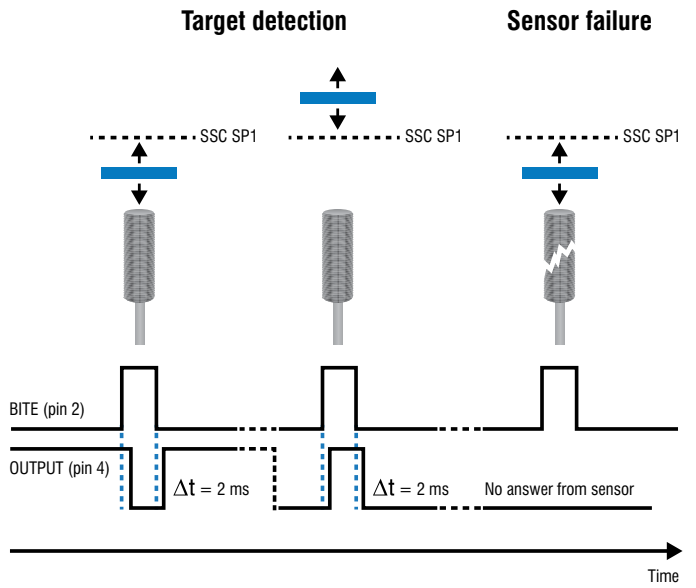

## TEACH FUNCTION

Teaching the sensor externally to recognize one or more setpoints is another D2D function. Smart Sensors are supplied with default (factory-set) values for SP1 and SP2; during commissioning, engineers use either a locally connected teach device or a remote PLC to communicate with the Smart Sensor via OSS2.

### EXTERNAL TEACH (high/low signal on pin 2)

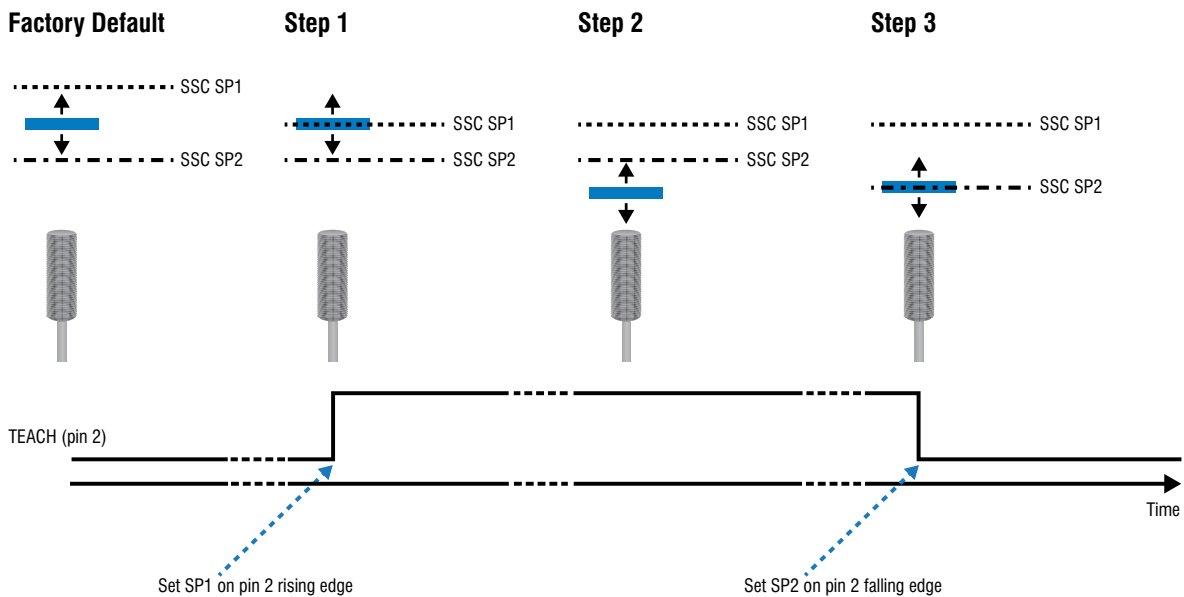

Positioning the target at the first setpoint and triggering the teach pulse sets SP1 on the rising edge of the pulse. Repositioning the target to the second setpoint and removing the teach pulse then sets SP2 on the falling edge of the pulse.

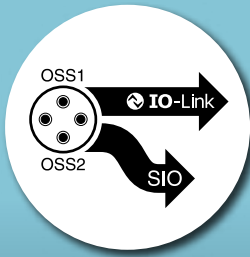

# DUAL CHANNEL

- ✓ **IO-Link smart profile simplifies control-system integration**
- ✓ **High-speed sensor-based decision-making using SIO**

## LOCALIZED HIGH-SPEED CONTROL

Enabling OSS2 on Pin 2 of the Smart Sensor connector gives system integrators access to localized high-speed control options; as already noted, OSS2 operates solely in SIO mode and may be designated as an input or an output channel. In addition to D2D communication, two specific advantages stand out.

### REPORTING TIME-CRITICAL EVENTS

Should a remote sensor identify an out-of-range parameter that requires immediate intervention, (for example, overheating), an event-based output signal is generated to notify the central control system – in the example shown, a PLC – that a system-wide shut-down is essential. In this instance, the IO-Link output (OSS1) may not respond quickly enough to prevent the problem escalating.

Using the SIO output on OSS2, the sensor delivers a high-speed notification directly to the PLC, bypassing the IO-Link channel and initiating the shut-down sequence immediately. The Smart Sensor’s dual-channel capability ensures that further, costly damage is avoided and that subsequent process down-time is minimized.

### DECENTRALIZED CONTROL

Smart Sensors are also ideally suited to non-critical, decentralized process tasks under local control. In the example shown, a local SIO input signal on OSS2 enables or inhibits the operation of the sensor without the need to route the command via the PLC. This configuration consumes little or no system-wide resource, requiring only a confirmatory IO-Link signal on OSS1 to update the sensor status in due course.

With OSS2 signal alternatively configured in output mode, the Smart Sensor may, for example, control the operation of a local sub-system, again without the need to route the command via the PLC. Using the signal to switch a simple two-state device allows the sensor to control the operation of any associated non-intelligent equipment, for example an actuator or an electrical circuit.

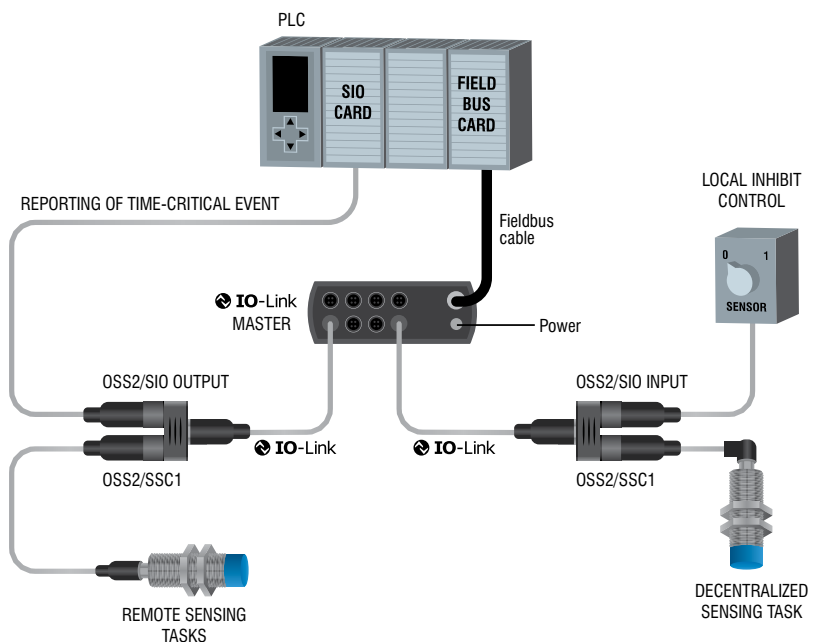



## PREDICTIVE MAINTENANCE FEATURES

- ✓ **Condition-based self-monitoring minimizes maintenance costs**
- ✓ **Plug-and-play sensor replacement**

## SAVING TIME BY DESIGN

In a fast-moving process-manufacturing environment, down-time is a major cost factor. While some interruptions to production are inevitable, minimizing lost time is a priority, and Smart Sensors offer big benefits here, saving time by design.

### PLUG-AND-PLAY REPLACEMENT

Once initial commissioning is completed, each sensor's configuration is stored automatically on the local IO-Link Master; this allows plug-and-play replacement of sensors should the need arise, without any loss of functionality and without any need for recalibration. Down-time and the associated maintenance cost is kept to a minimum.

## CYCLICAL AND EVENT-BASED REPORTING

The Smart Sensor's predictive-maintenance capabilities rely on its ability to collect both process data and event data, as well as making use of its on-board cumulative-data stores. Not only can maintenance engineers monitor long-term equipment behavior, they also have confidence in the sensor's ability to flag any one-off threshold exceptions that require attention.

### THRESHOLD EXCEPTIONS

The sensor's records cumulative data for distance, cycle count and temperature, with alarm thresholds set for each. Cumulative cycle-count limits for the expected life of the equipment being monitored are programmed into the sensor, and a threshold alarm is triggered when the set value is exceeded, typically via IO-Link, although a high-speed SIO output may be used instead.

In the case of distance and temperature, a single, ultimate limit for each parameter is set, and any measurement that exceeds either limit is sufficient to trigger an alarm; in this instance, a high-speed SIO signal is almost certainly the preferred option. Cumulative temperature measurements may also trigger a parametric-shift alarm, as explained below.

Distance

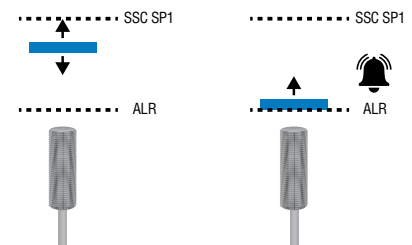

Counter



Temperature



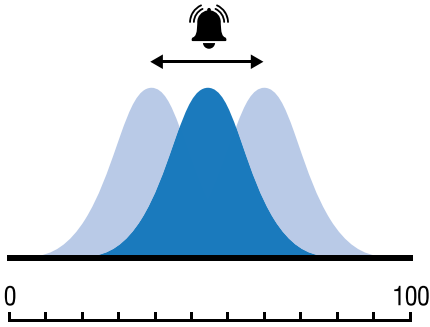

### PARAMETRIC SHIFT

Stored measurements from a prolonged period of operation provide maintenance engineers with a pattern of data over time; typically, the data will form a normal distribution centered around the expected mean value for the parameter in question. Examples include, but are not limited to, equipment temperature (as above) and amplitude of vibrations.

The comprehensive data patterns allow engineers to recognize any parametric shifts that occur over time. These may include a shift in the mean value, where, for example, a sustained rise in temperature occurs at a level that isn't high enough to trigger a threshold alarm. Alternatively, an increase in the standard deviation of measurements, for example, when vibrations become unstable, may result. In either case, a parametric-shift alarm is triggered, allowing engineers to take remedial action.

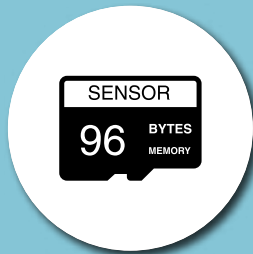

## USER-DEFINED MEMORY

- ✓ **Unique embedded sensor ID eliminates installation errors**

## EMBRACING THE INTERNET OF THINGS

The advent of the Internet of Things (IoT) has changed the way engineers look at integrated processes in manufacturing and logistics. No longer do system designers consider production lines and distribution centers to be made up of discrete components – conveyors, actuators, motors, sensors, controllers and other similar hardware – but instead they consider more complex Functional Units.

Working with a functional unit, the need to identify individual components remains as important as ever; installing the wrong sensor could have far-reaching consequences. Contrinex Smart Sensors make it simple to get the right device in the right place, eliminating errors and avoiding costly interventions.

### CUSTOMIZED SENSOR-DATA TAGS

Within each Smart Sensor, three read-write data tags are reserved for user-defined information. Designated the function tag, the location tag and the application-specific tag, respectively, they link individual sensors to specific applications or tasks, allowing process engineers to locate a discrete device quickly and easily. This simplifies installation and maintenance when more than one sensor is used in a single functional unit.

TAG NAME	SIZE [BYTE]	EXAMPLES
Function Tag	32	"Drive", "Feed", "Forward"
Location Tag	32	"AQ3.1", "S45-2"
Application-Specific Tag	32	"end of motion", "piston #1", "fwd stroke"

# SMART SENSORS SMART TASKS

## PNEUMATICS

### MULTI-MODE MEASUREMENT OF PISTON DISPLACEMENT AND SPEED

Industrial equipment designers continually seek ways to reduce cycle times without compromising safety or increasing cost, and require a monitoring capability for pneumatic cylinders that identifies deviations from the optimal deceleration profile without increasing complexity or cost. Rugged, multi-mode Smart Sensors from Contrinex, embedded in each cylinder, identify adverse trends in the deceleration profile, providing a cost-effective, unobtrusive fit-and-forget solution.

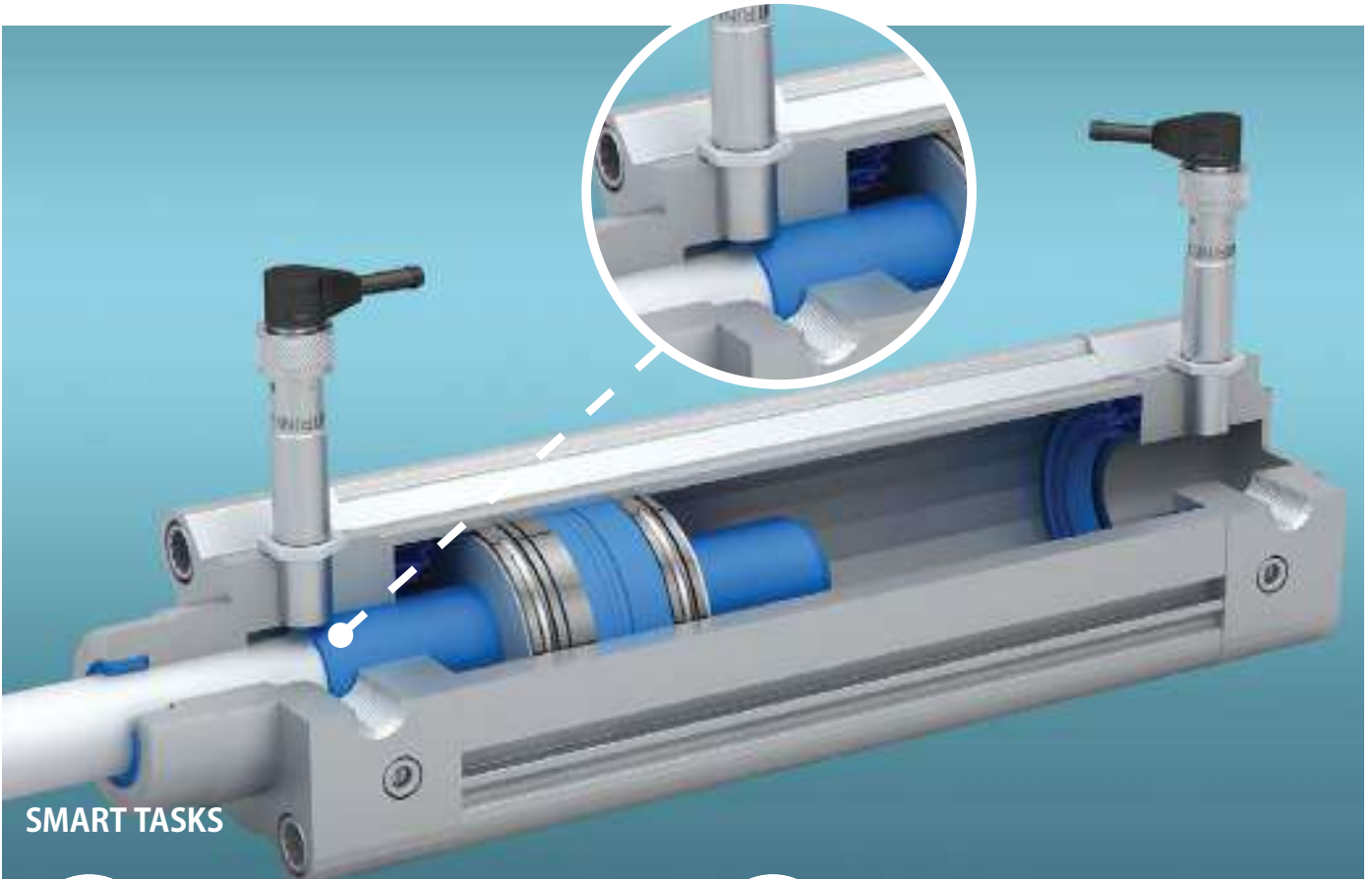

### SMART TASKS



- High-resolution measurement of lateral piston displacement
- Repeated high-speed displacement measurement at timed intervals



- Monitor temperature, vibration and process cycle count for maintenance purposes
- Local storage of sensor configurations, allowing plug-and-play replacement when needed



- Generation of velocity gradient using on-board cumulative data store



- High-speed communication with central control system for time-critical events

### CUSTOMER BENEFITS

- ✓ Embeddable inductive Smart Sensors offer multiple sensing modes in a single device, eliminating increased complexity and cost
- ✓ One-shot timer feature allows process engineers to identify deviations from the optimal deceleration profile, minimizing maintenance expense
- ✓ Dual-channel capability enables a local alarm to be triggered by an event-based exception, avoiding a plant-wide shut-down
- ✓ Industry-standard IO-Link connectivity provides a single interface to the machine control system
- ✓ Cumulative operating data for predictive maintenance, including temperature and operating-cycle count, is recorded in on-board data storage
- ✓ Sensor configurations are stored locally, allowing plug-and-play replacement of sensors when needed
- ✓ Proven technology ensures highly reliable fit-and-forget operation with no manual intervention



## LINEAR GUIDE

### PERFECT LOCATION AND POSITIONING OF LINEAR STAGE

Automation engineers designing high-speed assembly equipment with multiple linear transfers between workstations need to maximize speed and accuracy while keeping cost down. They require a single-sensor positional-control solution that delivers a high-speed approach to the critical areas and a slower, high-precision final positioning. An inductive Smart Sensor from Contrinex with IO-Link connectivity and multiple user-configurable outputs performs both the required tasks in a highly cost-effective manner.

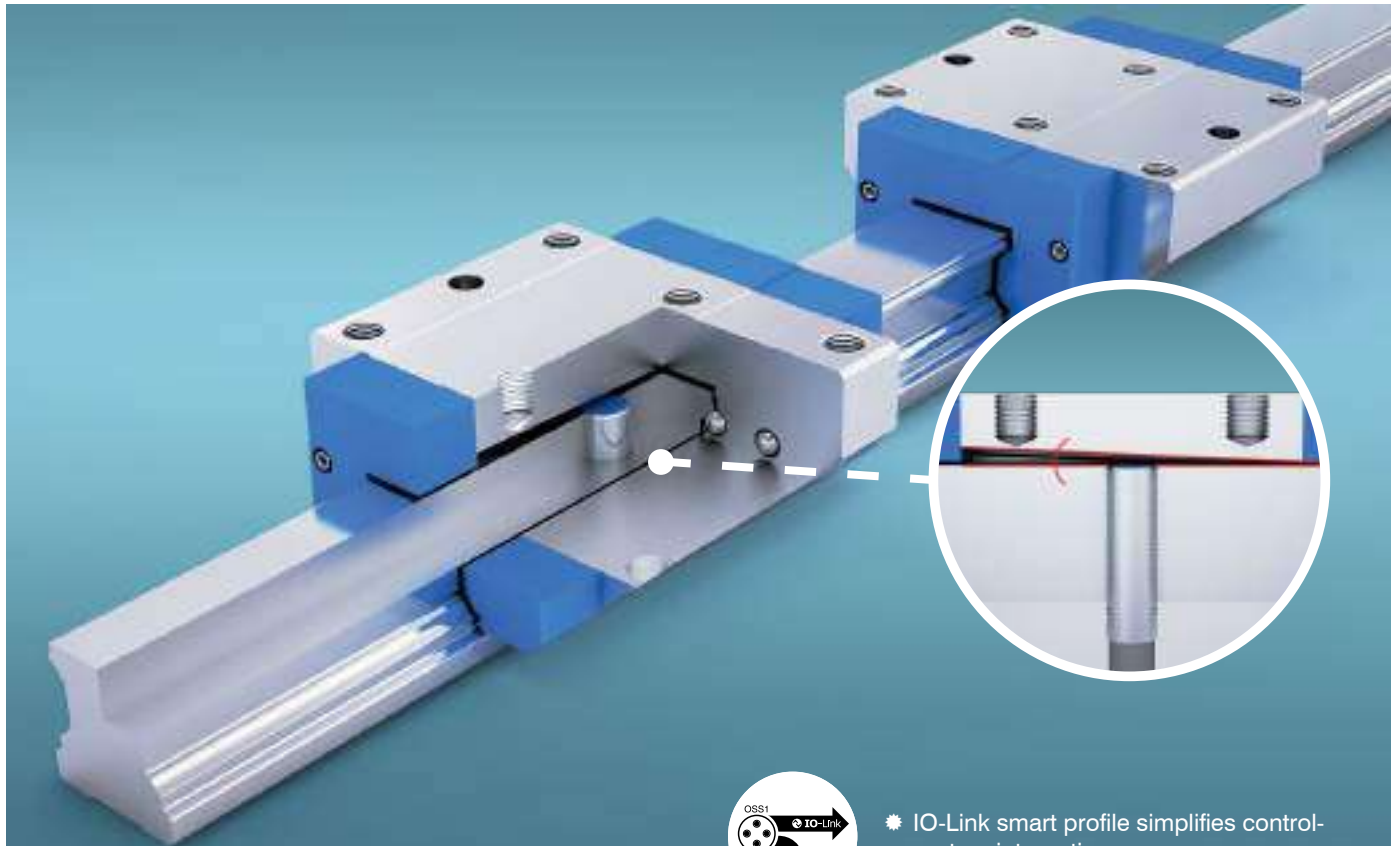

### SMART TASKS



- Reliable position sensing on high-speed approach
- High-accuracy lateral position measurement during final stage positioning



- User-configured setpoints ensure precise window-mode positioning



- IO-Link smart profile simplifies control-system integration



- Sensor configuration is backed-up automatically on the local IO-Link Master

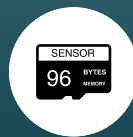

- Unique embedded sensor ID eliminates installation errors

### CUSTOMER BENEFITS

- ✓ Rugged inductive Smart Sensors ensure accurate positioning of linear stages without compromising operational speed
- ✓ Single-sensor positional-control system is non-complex and highly affordable
- ✓ Compact embeddable M12 sensors fit unobtrusively and easily into off-the-shelf linear guide rails
- ✓ Industry-standard IO-Link connectivity provides a single interface to the machine control system
- ✓ Sensor configurations are stored locally, allowing plug-and-play replacement of sensors when needed
- ✓ Proven technology ensures highly reliable fit-and-forget operation with no manual intervention

# SMART SENSORS SMART TASKS

## SPINDLE

### CHECKING TOOL PRESENCE AND POSITION IN A CONFINED SPACE

Modern CNC machining centers cope with ranges of materials, workpieces and cutting speeds that require different tool characteristics; spindles with automatic tool-changing are key to optimizing throughput. If a new tool fails to engage completely, damage to the tool, the workpiece or the spindle results. Smart Sensors from Contrinex, embedded in the body of the spindle, monitor the position of the tool during changes; any noncompliant measurements stop the process, triggering an alarm.

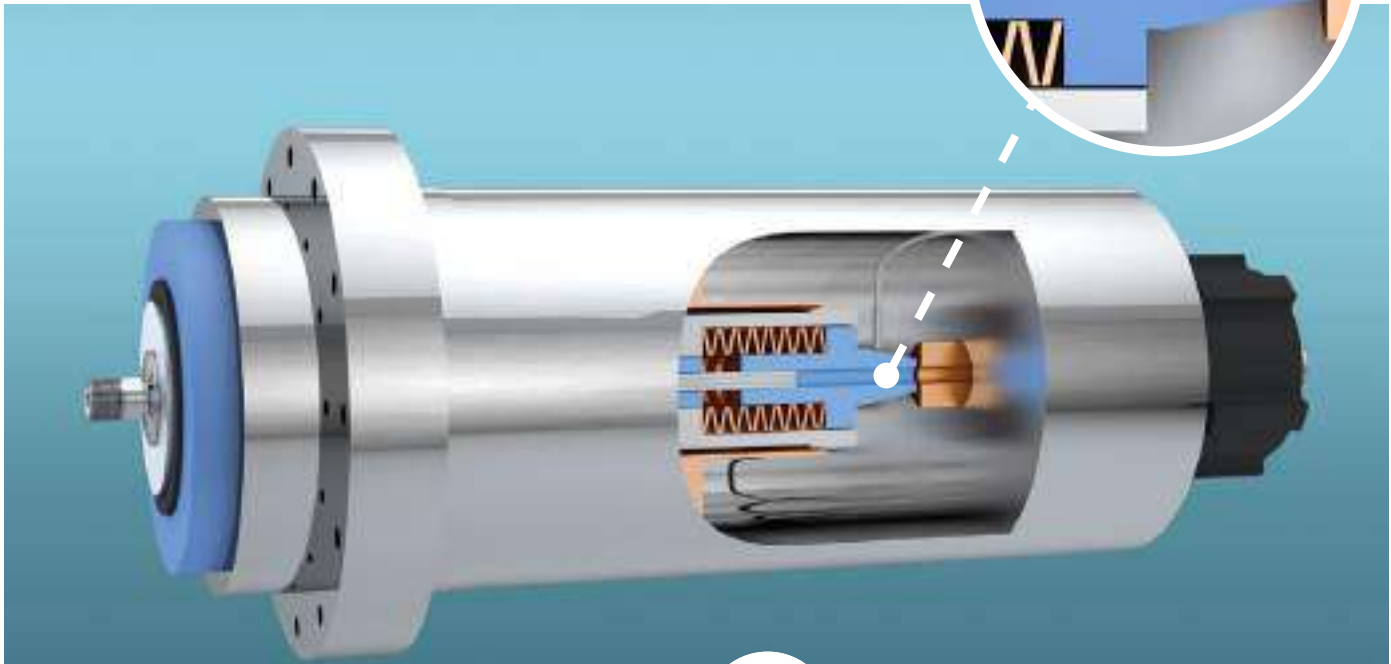
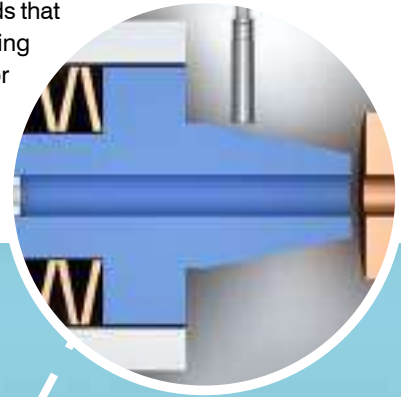

### SMART TASKS



- Precision real-time measurement of drawbar position



- User-configured setpoints ensure accurate end-of-travel position sensing



- High-speed notification of time-critical events



- Threshold alarms identify over-temperature and end of service life
- Sensor configuration is backed-up automatically on the local IO-Link Master



- Self-test function guards against sensor failure

### CUSTOMER BENEFITS

- ✓ Embeddable inductive Smart Sensor monitors drawbar position, detecting incomplete tool engagement and inhibiting further motion before damage occurs
- ✓ Single-sensor positional-control system is non-complex and highly affordable
- ✓ Embeddable M12 sensor fits snugly in the limited space available
- ✓ Industry-standard IO-Link connectivity provides a single interface to the machine control system
- ✓ Cumulative operating data for predictive maintenance, including temperature and operating-cycle count, is recorded in on-board data storage
- ✓ Sensor configurations are stored locally, allowing plug-and-play replacement of sensors when needed
- ✓ Proven technology ensures highly reliable fit-and-forget operation with no manual intervention



# RECYCLING

## RELIABLE DETECTION OF DIFFERENT METALLIC MATERIALS

The global recycling industry continually seeks to reduce the cost of sorting and separating mixed-metal scrap. With the introduction of induction sorting, designers require sensors that operate accurately and at high speed to identify and separate fast-moving streams of ferrous and non-ferrous material in a single pass. Rugged inductive Smart Sensors from Contrinex, embedded immediately below the delivery belt, provide continuous high-speed detection across the full width of a conveyor.



### SMART TASKS



- Multi-mode target recognition at constant target distance



- Unique embedded sensor ID eliminates installation error



- High-speed localized communication with air-knife actuators



- Cumulative cycle/target counting in each of two modes
- Threshold alarms identify over-temperature and end of service life
- Sensor configuration is backed-up automatically on the local IO-Link Master

### CUSTOMER BENEFITS

- ✓ Embeddable inductive Smart Sensors detect ferrous and non-ferrous metal and trigger separation accurately and reliably
- ✓ A single array of sensors provides continuous detection across the full width of a conveyor
- ✓ Smart Sensors are easily able to identify material on fast-moving conveyors
- ✓ Industry-standard IO-Link connectivity provides a single interface to the machine control system
- ✓ Cumulative operating data for predictive maintenance, including temperature and operating-cycle count, is recorded in on-board data storage
- ✓ Sensor configurations are stored locally, allowing plug-and-play replacement of sensors when needed
- ✓ Proven technology ensures highly reliable fit-and-forget operation with no manual intervention

# SMART SENSORS PRODUCT OVERVIEW



## COMMON FEATURES

Supply Voltage range	15 ... 30 VDC
Output	PNP NO

## OUTPUT

Mounting  
[E] Embeddable [N] Non-embeddable

IDW[x]-M[x]M[x]-NMS-AO

Housing size  
[8] Diameter 8 mm  
[12] Diameter 12 mm  
[18] Diameter 18 mm

Front material  
[M] Metal  
[P] Plastic

Reference key on page 24

## ACCESSORIES

- A** Group A: M8 3-pin  
Sub-group: Field attachable connectors  
Sub-group: Distribution boxes
- B** Group B: M8 4-pin
- C** Group C: M12 4-pin  
Sub-group: Field attachable connectors  
Sub-group: Distribution boxes
- D** Group D: M12 AC/DC 3-pin
- E** Group E: Universal mounting brackets  
Sub-group: Mechanical stops
- F** Group F: Photoelectric mounting brackets
- G** Group G: Photoelectric reflectors
- H** Group H: Sensor tester

Go to page 298 for details

FAMILY	OPERATING DISTANCE (mm)	HOUSING SIZE (mm)	HOUSING LENGTH (mm)	HOUSING MATERIAL
EXTRA DISTANCE SERIES 500	4	M8	66	Chrome-plated brass
	6	M8	66	Chrome-plated brass
	6	M12	60	Chrome-plated brass
	10	M12	60	Chrome-plated brass
	10	M18	63.5	Chrome-plated brass
	20	M18	63.5	Chrome-plated brass

FULL INOX SERIES 700*	6	M12	60	Stainless steel V2A
	10	M18	63.5	Stainless steel V2A

\*Available from Q1/2022

T-CONNECTOR	CONNECTION 1	
	SIZE	PINS
	M12 socket	5



	CONNECTOR	IO-Link	SAMPLING FREQUENCY (Hz)	MOUNTING		AMBIENT TEMPERATURE	DEGREE OF PROTECTION	PART REFERENCE	ACCESSORIES (SEE PAGE 22)
				EMB.	NON-EMB.				
	M12	IO-Link	1,000	Embed.		-25...+70°C	IP67	IDWE-M8MP-NMS-A0	C E H
	M12	IO-Link	1,000	Non-embed.		-25...+70°C	IP67	IDWN-M8MP-NMS-A0	C E H
	M12	IO-Link	1,000	Embed.		-25...+70°C	IP67	IDWE-M12MP-NMS-A0	C E H
	M12	IO-Link	1,000	Non-embed.		-25...+70°C	IP67	IDWN-M12MP-NMS-A0	C E H
	M12	IO-Link	1,000	Embed.		-25...+70°C	IP67	IDWE-M18MP-NMS-A0	C E H
	M12	IO-Link	1,000	Non-embed.		-25...+70°C	IP67	IDWN-M18MP-NMS-A0	C E H
	M12	IO-Link	1,000	Embed.		-25...+70°C	IP68 / IP69K	IDWE-M12MM-NMS-A0*	C E H
	M12	IO-Link	1,000	Embed.		-25...+70°C	IP68 / IP69K	IDWE-M18MM-NMS-A0*	C E H

	CONNECTION 2		CONNECTION 3		PART REFERENCE
	SIZE	PINS	SIZE	PINS	
	M12 plug	5	M12 socket	5	V12-5TPD-000-NN1



# SMART SENSORS REFERENCE KEY

## IDWE-M8MP-NMS-A0 (-XXX)

### SMART SENSOR PLATFORM

Digital measuring and switching	ID
Analog measuring	IA
Adjustable switching	IS

### SENSING PRINCIPLE

Inductive	W
Photoelectric distance	D
Photoelectric background suppression	H
Photoelectric through beam	L
Photoelectric reflex	R
Photoelectric diffuse	T

### MOUNTING / EMISSION TYPE

Embeddable	E
Non-embeddable	N
Red LED	R

### HOUSING TYPE

Rectangular	C
Cylindrical, threaded	M
Cylindrical, high-pressure resistant	P

### HOUSING SIZE

<b>Cylindrical</b>	
Ø8 mm	8
Ø12 mm	12
Ø18 mm	18
<b>Rectangular</b>	
2# mm × 3# mm	23

### HOUSING MATERIAL

Metal	M
Plastic	P

### SPECIAL EXECUTIONS

#### OUTPUT 2 (PIN 2)

<b>Switching Outputs</b>	
PNP NO	0
<b>Analog measuring</b>	
Linear voltage output 0–5 V	1
Linear voltage output 0–10 V	2
Linear current output 1–5 mA	3
Linear current output 4–20 mA	4

#### OUTPUT 1 (PIN 4)

<b>Switching Outputs</b>	
PNP NO / IO-Link	A
<b>Analog measuring</b>	
PNP NO / IO-Link	A
Linear voltage output 0–5 V	1
Linear voltage output 0–10 V	2

### CONNECTION

Cable	K
Connector	S

### DETECTION RANGE

Standard	M
Short	S

### ADJUSTMENT

No local user interface	N
-------------------------	---

### SENSING FACE MATERIAL

Metal	M
Plastic	P



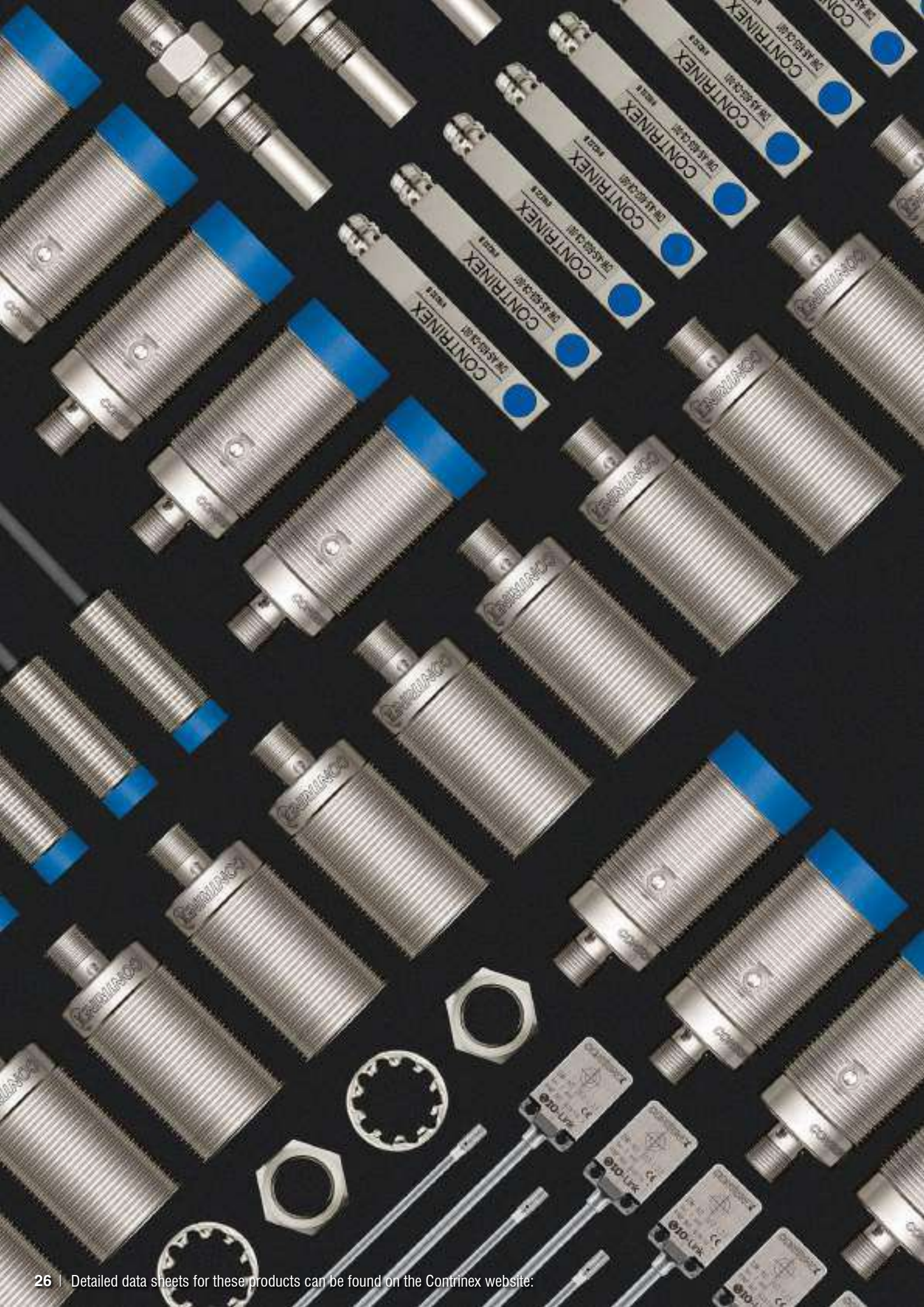



# INDUCTIVE SENSORS

## HIGHLIGHTS

- ✓ Smallest self-contained miniature inductive sensors with  IO-Link on the market
- ✓ Practically indestructible Full Inox sensors for extreme conditions
- ✓ Weld-Immune Full Inox sensors, M8, M12, M18, M30, C23
- ✓ Full Inox sensors with Factor 1 on steel and aluminum
- ✓ Sensors with 4× standard operating distance
- ✓ Outstandingly durable sensors for high cyclic pressures (peak: 1000 bar / 14510 psi)
- ✓ Highly accurate analog output sensors for distance control
- ✓ Sensors to withstand high temperatures (up to 230°C / 446°F)
- ✓ Ecolab-approved sensors

## NEW

- ✓ Full Inox Chip-Immune sensors for machining environments
- ✓ Full Inox Maritime DNV-GL approved sensors

# INDUCTIVE SENSORS PROGRAM OVERVIEW

FAMILY	HOUSING SIZE (mm)	OPERATING DISTANCE (mm)	BASIC	MINIATURE	EXTREME	ANALOG OUTPUT
CLASSICS – SERIES 600	Ø 3	1		☑ p. 50–51		
	M4	1		☑ p. 50–51		
	Ø 4	1.5		☑ p. 50–51		
	M5	1.5		☑ p. 50–51		
	C5	1.5		☑ p. 52–53		
	Ø 6.5	4	☑ p. 38–41			
	M8	6	☑ p. 40–43			
	C8	2	☑ p. 42–43			
	M10	0.6				
	M12	8	☑ p. 42–43			
	M18	8	☑ p. 42–45			
	M30	25	☑ p. 44–45			
	M50	25				
40 × 40	40	☑ p. 44–45				
EXTRA DISTANCE – SERIES 500	Ø 4	2.5		☑ p. 50–51		
	M5 / P5	2.5		☑ p. 50–51		
	Ø 6.5	3	☑ p. 36–37			
	M8 / P8	6	☑ p. 36–37			☑ p. 62–63
	C8	4	☑ p. 36–37			☑ p. 62–63
	M12 / P12	10	☑ p. 36–37			☑ p. 62–63
	M18	20	☑ p. 36–39			☑ p. 62–63
	M30	40	☑ p. 38–39			☑ p. 64–65
	M14 / P20	3				
FULL INOX – SERIES 700	Ø 4	3		☑ p. 52–53		
	M5	3		☑ p. 52–53		
	M8	6	☑ p. 46–47		☑ p. 56–57	
	M12 / P12	15	☑ p. 46–47		☑ p. 56–57	
	M18	20	☑ p. 46–47		☑ p. 56–57	
	M30	40	☑ p. 46–47		☑ p. 56–59	
	C23	7			☑ p. 58–59	



	2-WIRE	EXTRA/HIGH PRESSURE UP TO 1,000 BAR PEAK	EXTRA TEMP. HIGH TEMP. -40 TO +230°C	WELD-IMMUNE	CHIP-IMMUNE	DOUBLE-SHEET	MARITIME	WASHDOWN
	p. 68-69	🔄 p. 76-77						
	p. 68-69							
	p. 68-69	🔄 p. 76-77						
	p. 68-69		🔄 p. 86-87					
	p. 68-69							
	p. 68-69							
	p. 68-69		🔄 p. 86-87, p. 90-91	p. 98-99				
							🔄 p. 110-111	
	p. 68-71		p. 86-87, p. 90-91	p. 98-99				🔄 p. 114-115
	p. 70-73		🔄 p. 86-87, p. 90-91	p. 98-99				
	p. 72-73		p. 90-91					
			p. 90-91					
		🔄 p. 80-81						
		🔄 p. 76-77						
		🔄 p. 76-77, p. 80-81						
		🔄 p. 80-81						
		🔄 p. 80-81						
				🔄 p. 96-97				
		🔄 p. 82-83		🔄 p. 96-97	🔄 p. 104-105		🔄 p. 110-111	🔄 p. 114-115
				🔄 p. 96-97	🔄 p. 104-105		🔄 p. 110-111	🔄 p. 114-115
				🔄 p. 96-97	🔄 p. 104-105	p. 106-107	🔄 p. 110-111	🔄 p. 114-115
				🔄 p. 96-97			🔄 p. 110-111	

# INTRODUCTION

## TECHNOLOGY

Contrinex inductive devices work according to one of three different technologies. All involve the generation of an alternating magnetic field that emerges at the sensing face. The presence of a conductive, generally metallic, object influences this field in a way that can be detected and evaluated by built-in electronics. All Contrinex ASIC sensors are IO-Link enabled in PNP NO versions.

## TECHNOLOGY FAMILIES

### CLASSICS FAMILY

Conventional technology, engineered by Contrinex

The **Classics** family uses conventional inductive sensor technology, but with the benefit of a Contrinex ASIC (application specific integrated circuit). ASIC technology ensures reliability, stability and ease of commissioning, due to low variation. Sensors in this family achieve operating distances up to 2× the industry standard. All ASIC sensors in the **Classics** family are IO-Link enabled in PNP NO versions.

**Classics** sensors have a conventional oscillator and coil generating a high-frequency magnetic field that emerges at the sensing face. Any metallic object found in this field absorbs some of the energy, which is in turn detected and evaluated by built-in electronics (Fig. 1).

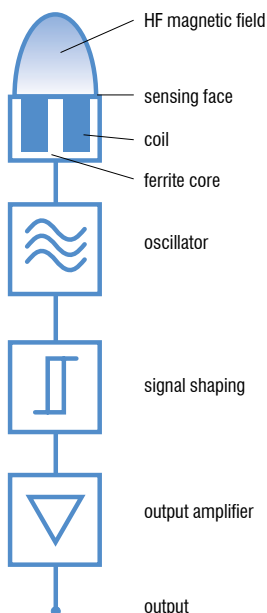

Fig. 1: Conventional inductive sensor technology, as used in the Classics family

Ferromagnetic metals (steel, nickel, cobalt) absorb the most energy. The achievable operating distances are therefore greatest with these metals. Non-ferromagnetic metals, such as aluminum, absorb less energy. As a result, operating distances are lower (approx. 25... 45% of those on steel).

The **Classics** technology family (series 600) includes devices from the ranges **Basic**, **Miniature**, **Extra Pressure**, **Extra Temperature**, **High Temperature**, **Washdown** and **2-Wire**.

### EXTRA DISTANCE FAMILY

Increased stability for exceptionally long operating distance

The **Extra Distance** family is based on the **Condist®** oscillator developed by Contrinex. Sensors benefit from **up to 4× the standard** operating distance, keeping them out of harm's way in rugged, industrial environments. Sensor lifetime is therefore increased.

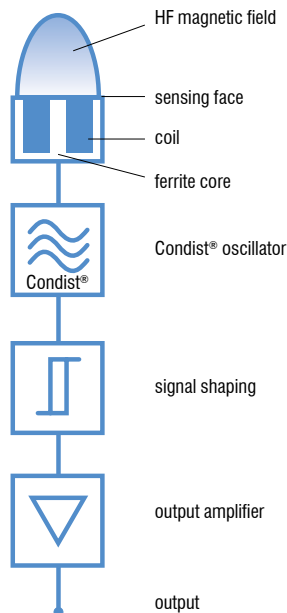
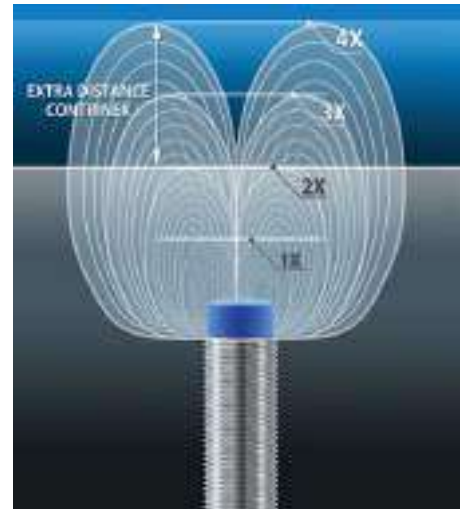

Fig. 2: Contrinex's Condist® inductive sensor technology, as used in the Extra Distance family



Like **Classics** family sensors, these also generate a high-frequency magnetic field that emerges at the sensing face (Fig. 2). Again, the resulting effect is that any metallic object entering the field absorbs energy from it.

However, the oscillator and the subsequent signal evaluation circuit are completely different, with the objective of achieving a significantly **better stability** with respect to environmental influences, in particular temperature. The most important contribution to this comes from the Contrinex **Condist®** oscillator.

Improved stability permits the switch point to be further away, leading to **long operating distances** on ferromagnetic metals (Fig. 3). Sensors with this technology also react particularly well to **narrow targets**, e.g. small screws, wires and foils.

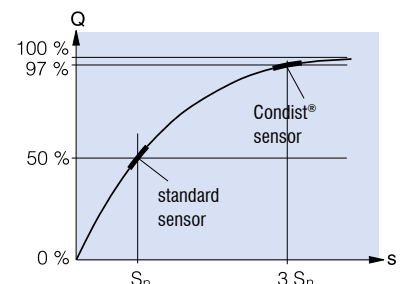

Fig. 3: Extra Distance family sensors have a longer operating distance, due to Condist® oscillator technology

Apart from the **Condist®** oscillator, all other assemblies are equivalent to the **Classics** family. Material

dependencies and other properties are also the same as for **Classics** family sensors.

Special attention has been paid to **meet the relevant standards as much as possible**, so that easy **interchangeability** with conventional devices is guaranteed. Great emphasis has been placed on very good EMC resistance and on perfect sealing against liquid penetration.

The **Extra Distance** technology family includes devices from the **Basic, Miniature, Extra Pressure, High Pressure** and **Analog Output** ranges. This technology is used in series 500 devices.

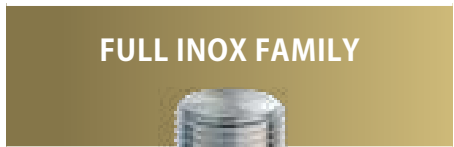

**All-round stainless steel protection – practically indestructible**

The **Full Inox** family is based on Contrinex's Condet® technology. These one-piece stainless steel sensors are not only the most durable on the market, they also offer long operating distances on any conductive metal.

**Full Inox** sensors also function according to inductive technology. However, the coil which generates



the magnetic field is not part of the oscillator (Fig. 4). Instead, the field is generated by periodic, short transmitter current pulses, which flow through the coil (Fig. 5). This field induces a voltage in the target which, in turn, generates a current flow in it. When the **transmitter current pulse** is switched off, the current in the object dies away, causing a **voltage to be induced** in the transmitting coil (Fig. 6).

**by the target's material.** Operating distances are therefore identical on steel and aluminum. Only metals which are non-ferromagnetic and also have poor electrical conductivity give a reduced usable signal.

The **Full Inox** family includes devices from the **Basic, Miniature, Extreme, High Pressure, Wash-down, Weld-Immune, Chip-Immune, Maritime** and **Double-Sheet** ranges.

This voltage generates the signal required, and is in principle **independent of the field's energy loss**. Therein lies the fundamental advantage of this technology, since the field energy losses, which are evaluated in conventional sensors, are subject to a number of undesirable environmental and material influences. Condet® technology allows the sensor, including its face, to be fully encapsulated in a protective, stainless steel housing, with the added security of long operating distances.

The coupling between the target and the coil is rather **like a transformer**, and is hence **temperature independent** and only **slightly influenced**

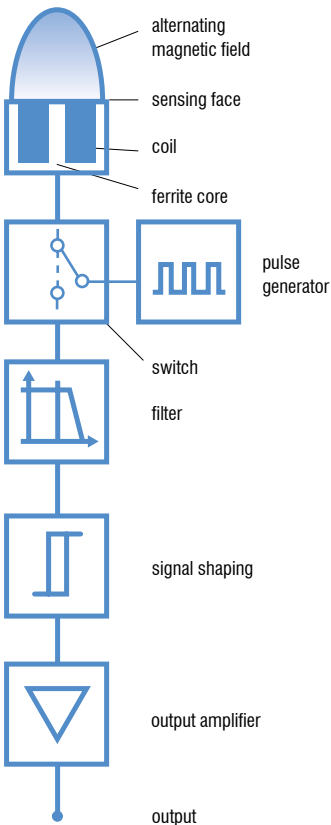

Fig. 4: Full Inox family sensors use Condet® pulse generator technology instead of an oscillator

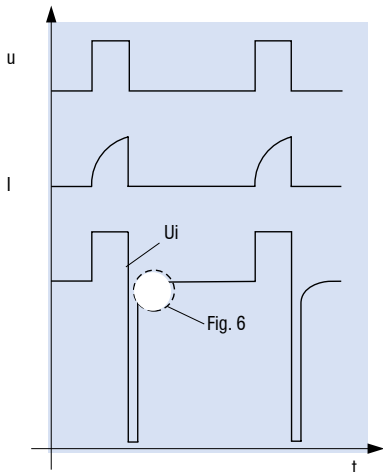

Fig. 5: Evolution of main signals

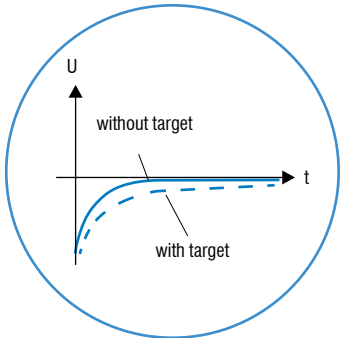

Fig. 6 (detail fig. 5): Effect of a target on the measured signal

# INDUCTIVE SENSORS



## BASIC

First choice in all environments



Contrinex **Basic** range inductive sensors have a worldwide and well-deserved reputation for uncompromising accuracy and exceptional reliability. With best-in-class sensing distances between **1.5 mm** and **40 mm**, the Basic range offers fit-and-forget operation, delivering world-class performance and a highly attractive total cost of ownership.



## ANALOG OUTPUT

Continuous analog output for precision control

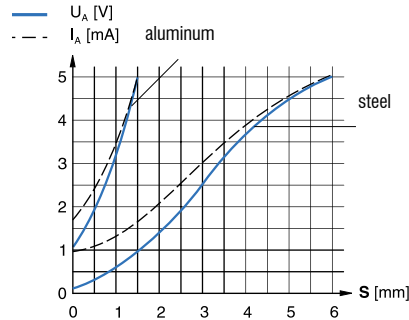

Fig. 7



## EXTRA PRESSURE

Pressure resistant up to 200 bar



Dependable, accurate presence- and position-sensing at pressures up to **200 bar** requires world-class performance and build quality. The **Extra Pressure** range of pressure-resistant inductive sensors delivers exactly that, operating continuously in permanently pressurized conditions. This makes the range especially suitable for offshore installations, the chemical industry, motor lubrication systems and atomic fuel element monitoring. A stainless-steel housing with bonded ceramic or brazed sapphire sensing face and protection class **IP68** guarantees robustness and exceptional reliability in miniature packages sized from  $\varnothing 3$  to  $\varnothing 6.5$ .



## MINIATURE

Full functionality, smallest size



Size is often a critical constraint when selecting sensors for position- or presence-sensing. The Contrinex **Miniature** range, which includes the smallest self-contained inductive sensors on the market, meets this constraint without compromising on functionality.

Engineers needing a reliable, repeatable, highly accurate means of measuring the position of a target object should look no further than Contrinex **Analog Output** inductive sensors. This range of sensors has been developed on the platform of **Extra Distance** (Fig. 2) technology for excellent temperature stability, repeat accuracy, and the best long-range sensing capability on the market. With a measurement range of **zero to 40 mm** and detection accuracy on the micron scale, the **Analog Output** sensor range is ideally suited for measuring linear, angular and rotational position (Fig. 7).

Engineers needing a reliable, repeatable, highly accurate means of measuring the position of a target object should look no further than Contrinex **Analog Output** inductive sensors. This range of sensors has been developed on the platform of **Extra Distance** (Fig. 2) technology for excellent temperature stability, repeat accuracy, and the best long-range sensing capability on the market. With a measurement range of **zero to 40 mm** and detection accuracy on the micron scale, the **Analog Output** sensor range is ideally suited for measuring linear, angular and rotational position (Fig. 7).



## HIGH PRESSURE

Resistant to pressure and dynamic stress up to 500 bar



For reliable, accurate sensing in the most demanding pneumatic and hydraulic applications, Contrinex offers a unique range of **High Pressure** sensors with permanent operating pressures of **100 ... 500 bar** and peak pressures up to **1000 bar**.

Suitable for operating temperatures up to  $100^{\circ}\text{C}$  and resistant to more than one million pressure cycles, their IP68 and IP69K protection and oil impermeability make them the robust, reliable choice for the hydraulic industry. Fit-and-forget operation virtually eliminates sensor replacement costs. Exceptional performance and world-class quality are assured in sizes from M5 to M18.



## EXTREME

Extreme durability in harsh environments



Only the toughest sensors survive the most extreme environments, and **Extreme** range inductive sensors from the **Full Inox** family are ideally equipped for the job. Thanks to one-piece stainless-steel (V2A/AISI 303) construction and a hermetically sealed cable entry, **Extreme** sensors are corrosion-resistant, imper-

vious to oil, and pressure-resistant to **100 bar**. Rugged, reliable and highly accurate, the **Extreme** range is at home in the most challenging circumstances.



## 2-WIRE

Easy installation and high switching frequency



The **2-Wire** range of DC, AC/DC and NAMUR sensors is constructed on the **Classics** (Fig. 1) technology platform and includes sizes from  $\varnothing 3$  to M30, plus a  $5 \times 5$  mm square-section type. Devices are available for embeddable or non-embeddable mounting and connection is by means of cable or connector. With a sensing range up to 15 mm, Contrinex **2-Wire** sensors ensure optimal equipment utilization.



## EXTRA TEMPERATURE

Temperature resistant up to 120°C



Inductive sensors from the **Extra Temperature** range offer the ideal solution for position- and presence-sensing applications at temperatures from as low as minus 40°C up to 120°C. Industrial processes often generate heat, resulting in temperatures that would damage a standard sensor, but the

stainless-steel construction and robust electronics of Contrinex **Extra Temperature** sensors ensure reliable, accurate operation and minimal downtime, even in the most demanding environments.



## HIGH TEMPERATURE

Temperature resistant up to 180°C (230°C with external amplifier)



Contrinex **High Temperature** inductive sensors are designed for continuous operation at temperatures from 0°C up to 180°C (up to 230°C with remote electronics). The range is ideal for the harshest environments, including automotive paint shops, metal-treatment plants and glass manufacturing.



## WELD-IMMUNE

Immune to magnetic fields and resistant to weld spatter



Contrinex **Weld-Immune** inductive sensors are ideal for the harshest welding environments thanks to the revolutionary triple protection. The range includes anti-spatter coated, weld-field immune and impact resistant sensors. For extensive protection, we recommend using our accessories such as our coated mounting brackets, spatter-resistant cables and protective

tubes. Benefits include reduced cleaning and maintenance costs, longer sensor service-life and thus increased machine availability.



## CHIP-IMMUNE

For the harshest machining environments



Even when covered with chips of steel, stainless steel, aluminum, brass, copper or titanium, **Chip-Immune** inductive sensors from the **Full Inox** technology family will reliably detect targets made of these metals. The sensors achieve this with a slightly modified form of Condet® technology. In a one-piece stainless steel housing with **IP68/IP69K** protection rating and a wide operating temperature range

from -25 to +85°C (-13 to +185°F), they are particularly suitable for use in the harsh environments of the machining industry. Depending on sensor diameter (**M12**, **M18** or **M30**), operating distances of 3, 5 or 12 mm are available.

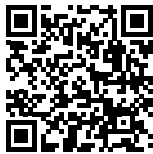

## DOUBLE-SHEET

Detection of double-sheets in metalworking



For double-sheet detection, sensors from the **Full Inox** (Fig. 4) family are used. Its inductive technology enables discrimination between one and two conductive metal sheets of a defined thickness, achieving sensitivity of 0.8–1.2 mm per sheet. This

discrimination aids in the prevention of double feeds into blanking and forming processes which ultimately saves damage to tooling. The one-piece, stainless-steel construction of these sensors makes them the most durable on the market. They withstand the impacts that are a common hazard in double-sheet detection applications close to moving sheet metal, ensuring minimal down-time.



## MARITIME

DNV approved for ships, ports and offshore



The **Maritime** range of embeddable inductive sensors, certified by DNV, offers unrivaled performance features based on **Full Inox** technology (Fig. 4). With a one-piece housing in V4A/AISI 316L stainless steel and an enclosure rating of IP68/IP69K, they are not only impervious, but also corrosion-proof and resistant to salt water. Their EMC protection also meets specific maritime requirements, particularly with regard to power supply variations and low frequency immunity. They offer the longest service life of any inductive sensor on the market, even in the harshest marine environments.

especially with regard to power supply variations and low frequency immunity. They offer the longest service life of any inductive sensor on the market, even in the harshest marine environments.



## WASHDOWN

Ecolab approved for harshest cleaning processes



**Washdown** inductive sensors are certified to operate continuously and reliably in the harsh conditions of the food, beverage and pharmaceutical industries, ensuring uninterrupted production. Rated to **IP68** and **IP69K**, they are pressure resistant up to **80 bar**, **food safe and corrosion resistant**; additionally Full Inox – Series 700 are **Ecolab** certified. Washdown sensors are available in conventional **Classics**

(Fig. 1) technology, size M12, or **Full Inox** (Fig. 4) technology, sizes M12, M18 and M30. Full Inox types have a totally impervious one-piece housing in stainless-steel (V4A/AISI 316L), including the sensing face. They are therefore highly resistant to the corrosive chemicals used for clean-in-place or wash-down processes.

$$1 + 1 = 2$$



## APPLICATION

### Extra Distance inductive sensors detect presence of metal washers in plastic assemblies

A plastics manufacturer tests batches of control knobs for in-car audio systems before shipment to automotive assembly plants; each knob contains a small metal washer that occasionally becomes dislodged. A custom-built testing machine tests a tray of 70 knobs in a single cycle; long-distance inductive sensors, positioned directly below the knobs, confirm the presence of a washer in each assembly.

## INDUSTRIES

Automotive production and supply, machine tool, energy, packaging, logistics, materials handling, textile, assembly, automation



*Textile spinning machine automation*



*Wind turbine speed monitoring*



*Presence sensing in automotive factory*



*Position detection on crane*

# BASIC

## INDUCTIVE SENSORS

### FIRST CHOICE IN ALL ENVIRONMENTS

Contrinex **Basic** inductive sensors have a worldwide and well-deserved reputation for uncompromising accuracy and exceptional reliability. With best-in-class sensing distances between **1.5 mm** and **40 mm**, the Contrinex **Basic** range offers fit-and-forget operation, delivering world-class performance and a highly attractive total cost of ownership.

#### KEY ADVANTAGES

##### Classics, Extra Distance and Full Inox

- ✓ High quality ASIC sensors
- ✓  IO-Link
- ✓ Exceptional price/performance ratio
- ✓ Excellent accuracy
- ✓ Outstanding temperature compensation
- ✓ Vibration and shock resistant
- ✓ Long operating distance

##### Full Inox

- ✓ Extremely robust one-piece stainless-steel housing
- ✓ Corrosion resistant
- ✓ IP68 and IP69K, water resistant
- ✓ Pressure resistant up to 80 bar (1,160 psi)



#### PRODUCT OVERVIEW

		 IO-Link						
Housing size mm		Ø6.5	M8	C8	M12	M18	M30	C44
s <sub>n</sub> mm	Extra Distance	3	3...6	3	6...10	12...20	22...40	–
	Classics	1.5...2	1.5...4	1.5...2	2...8	5...12	10...25	15...40
	Full Inox	–	2	–	3	5	10	–

#### ACCESSORIES

Go to page 298 to see all the accessories

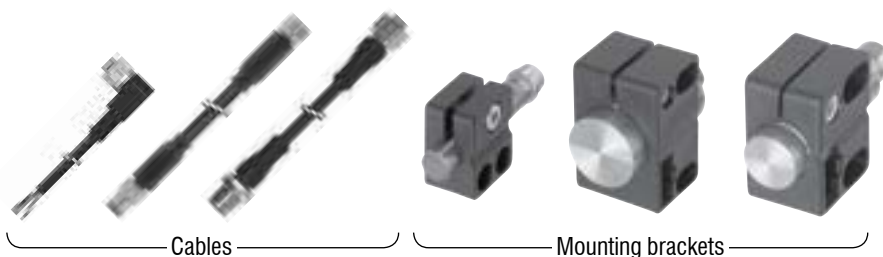

# INDUCTIVE SENSORS BASIC



## COMMON FEATURES

<b>Supply Voltage range</b>	10 ... 30 VDC
<b>Output</b>	PNP NO*

\* Other types available: PNP NC, NPN NC

\*\* Pigtail versions available

## OUTPUT

DW-A[x]-50[x]	
<b>Connection</b>	<b>Output</b>
[D] Cable [S] Connector [V] Pigtail	[1] NPN NO [3] PNP NO [2] NPN NC [4] PNP NC

Reference key on page 116

## ACCESSORIES

- A** Group A: M8 3-pin  
Sub-group: Field attachable connectors  
Sub-group: Distribution boxes
- B** Group B: M8 4-pin
- C** Group C: M12 4-pin  
Sub-group: Field attachable connectors  
Sub-group: Distribution boxes
- D** Group D: M12 AC/DC 3-pin
- E** Group E: Universal mounting brackets  
Sub-group: Mechanical stops
- F** Group F: Photoelectric mounting brackets
- G** Group G: Photoelectric reflectors
- H** Group H: Sensor tester

Go to page 298 for details

**CABLES**  
Cable lengths available:  
2 m, 5 m, 10 m  
other customised lengths possible

FAMILY	OPERATING DISTANCE (mm)	HOUSING SIZE (mm)	HOUSING LENGTH (mm)	HOUSING MATERIAL
EXTRA DISTANCE – SERIES 500	3	Ø 6.5	45	Chrome-plated brass
	3	Ø 6.5	66	Chrome-plated brass
	3	Ø 6.5	60	Chrome-plated brass
	3	M8	45	Chrome-plated nickel silver
	4	M8	45	Chrome-plated nickel silver
	6	M8	40.8	Chrome-plated brass
	3	M8	66	Chrome-plated nickel silver
	3	M8	60	Chrome-plated nickel silver
	4	M8	66	Chrome-plated nickel silver
	4	M8	60	Chrome-plated nickel silver
	6	M8	66	Chrome-plated brass
	6	M8	60	Chrome-plated brass
	3	8 × 8 (C8)	40	Chrome-plated brass
	3	8 × 8 (C8)	59	Chrome-plated brass
	6	M12	50	Chrome-plated brass
	6	M12	35	Chrome-plated brass
	8	M12	50	Chrome-plated brass
	8	M12	35	Chrome-plated brass
	10	M12	44.3	Chrome-plated brass
	10	M12	29.3	Chrome-plated brass
	6	M12	60	Chrome-plated brass
	6	M12	45	Chrome-plated brass
	8	M12	60	Chrome-plated brass
	8	M12	45	Chrome-plated brass
	10	M12	60	Chrome-plated brass
	10	M12	45	Chrome-plated brass
	12	M18	50	Chrome-plated brass
	20	M18	40	Chrome-plated brass
	12	M18	35	Chrome-plated brass
	20	M18	25	Chrome-plated brass



CABLE**	CONNECTOR**	IO-Link	SWITCHING FREQUENCY (Hz)	MOUNTING		AMBIENT TEMPERATURE	DEGREE OF PROTECTION	PART REFERENCE*	ACCESSORIES (SEE PAGE 36)
				EMB.	NON-EMB.				
PVC		IO-Link	1,000	Quasi-embed.		-25 ... +70°C	IP67	DW-AD-503-065	E H
	M12	IO-Link	1,000	Quasi-embed.		-25 ... +70°C	IP67	DW-AS-503-065	C E H
	M8	IO-Link	1,000	Quasi-embed.		-25 ... +70°C	IP67	DW-AS-503-065-001	A E H
PVC		IO-Link	1,000	Embed.		-25 ... +70°C	IP67	DW-AD-503-M8	E H
PVC		IO-Link	500	Embed.		-25 ... +70°C	IP67	DW-AD-523-M8	E H
PVC		IO-Link	500	Non-embed.		-25 ... +70°C	IP67	DW-AD-513-M8	E H
	M12	IO-Link	1,000	Embed.		-25 ... +70°C	IP67	DW-AS-503-M8	C E H
	M8	IO-Link	1,000	Embed.		-25 ... +70°C	IP67	DW-AS-503-M8-001	A E H
	M12	IO-Link	500	Embed.		-25 ... +70°C	IP67	DW-AS-523-M8	C E H
	M8	IO-Link	500	Embed.		-25 ... +70°C	IP67	DW-AS-523-M8-001	A E H
	M12	IO-Link	500	Non-embed.		-25 ... +70°C	IP67	DW-AS-513-M8	C E H
	M8	IO-Link	500	Non-embed.		-25 ... +70°C	IP67	DW-AS-513-M8-001	A E H
PVC		IO-Link	1,000	Quasi-embed.		-25 ... +70°C	IP67	DW-AD-503-C8	H
	M8	IO-Link	1,000	Quasi-embed.		-25 ... +70°C	IP67	DW-AS-503-C8	A H
PVC		IO-Link	800	Quasi-embed.		-25 ... +70°C	IP67	DW-AD-503-M12	E H
PVC		IO-Link	800	Quasi-embed.		-25 ... +70°C	IP67	DW-AD-503-M12-120	E H
PVC		IO-Link	400	Quasi-embed.		-25 ... +70°C	IP67	DW-AD-523-M12	E H
PVC		IO-Link	400	Quasi-embed.		-25 ... +70°C	IP67	DW-AD-523-M12-120	E H
PVC		IO-Link	400	Non-embed.		-25 ... +70°C	IP67	DW-AD-513-M12	E H
PVC		IO-Link	400	Non-embed.		-25 ... +70°C	IP67	DW-AD-513-M12-120	E H
	M12	IO-Link	800	Quasi-embed.		-25 ... +70°C	IP67	DW-AS-503-M12	C E H
	M12	IO-Link	800	Quasi-embed.		-25 ... +70°C	IP67	DW-AS-503-M12-120	C E H
	M12	IO-Link	400	Quasi-embed.		-25 ... +70°C	IP67	DW-AS-523-M12	C E H
	M12	IO-Link	400	Quasi-embed.		-25 ... +70°C	IP67	DW-AS-523-M12-120	C E H
	M12	IO-Link	400	Non-embed.		-25 ... +70°C	IP67	DW-AS-513-M12	C E H
	M12	IO-Link	400	Non-embed.		-25 ... +70°C	IP67	DW-AS-513-M12-120	C E H
PVC		IO-Link	600	Quasi-embed.		-25 ... +70°C	IP67	DW-AD-503-M18	E H
PVC		IO-Link	500	Non-embed.		-25 ... +70°C	IP67	DW-AD-513-M18	E H
PVC		IO-Link	600	Quasi-embed.		-25 ... +70°C	IP67	DW-AD-503-M18-120	E H
PVC		IO-Link	500	Non-embed.		-25 ... +70°C	IP67	DW-AD-513-M18-120	E H

# INDUCTIVE SENSORS BASIC



## COMMON FEATURES

Supply Voltage range	10 ... 30 VDC
Output	PNP NO*

\* Other types available: PNP NC, NPN NC

\*\* Pigtail versions available

## OUTPUT

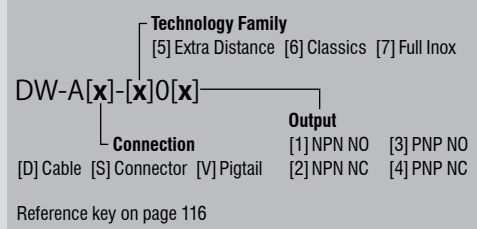

## ACCESSORIES

**A** Group A: M8 3-pin  
Sub-group: Field attachable connectors  
Sub-group: Distribution boxes

**B** Group B: M8 4-pin

**C** Group C: M12 4-pin  
Sub-group: Field attachable connectors  
Sub-group: Distribution boxes

**D** Group D: M12 AC/DC 3-pin

**E** Group E: Universal mounting brackets  
Sub-group: Mechanical stops

**F** Group F: Photoelectric mounting brackets

**G** Group G: Photoelectric reflectors

**H** Group H: Sensor tester

Go to page 298 for details

**CABLES**  
Cable lengths available:  
2 m, 5 m, 10 m  
other customised lengths possible

FAMILY	OPERATING DISTANCE (mm)	HOUSING SIZE (mm)	HOUSING LENGTH (mm)	HOUSING MATERIAL
EXTRA DISTANCE – SERIES 500	12	M18	63.5	Chrome-plated brass
	12	M18	48.5	Chrome-plated brass
	20	M18	63.5	Chrome-plated brass
	20	M18	48.5	Chrome-plated brass
	22	M30	60	Chrome-plated brass
	22	M30	73.5	Chrome-plated brass
	40	M30	50	Chrome-plated brass
	40	M30	73.5	Chrome-plated brass
	22	M30	35	Chrome-plated brass
	22	M30	48.5	Chrome-plated brass
	40	M30	25	Chrome-plated brass
	40	M30	48.5	Chrome-plated brass

CLASSICS – SERIES 600	1.5	Ø 6.5	36	Stainless steel V2A
	3	Ø 6.5	35	Stainless steel V2A
	1.5	Ø 6.5	35	Stainless steel V2A
	2	Ø 6.5	35	Stainless steel V2A
	2	Ø 6.5	36	Stainless steel V2A
	4	Ø 6.5	31	Stainless steel V2A
	4	Ø 6.5	36	Stainless steel V2A
	1.5	Ø 6.5	22	Stainless steel V2A
	2	Ø 6.5	22	Stainless steel V2A
	1.5	Ø 6.5	23	Stainless steel V2A
	2	Ø 6.5	23	Stainless steel V2A
	1.5	Ø 6.5	30	Stainless steel V2A
	2	Ø 6.5	30	Stainless steel V2A
	1.5	Ø 6.5	45	Stainless steel V2A
	2	Ø 6.5	45	Stainless steel V2A
	1.5	Ø 6.5	15	Stainless steel V2A
	1.5	Ø 6.5	15	Stainless steel V2A



CABLE**	CONNECTOR**	IO-Link	SWITCHING FREQUENCY (Hz)	MOUNTING		AMBIENT TEMPERATURE	DEGREE OF PROTECTION	PART REFERENCE*	ACCESSORIES (SEE PAGE 38)
				EMB.	NON-EMB.				
	M12	IO-Link	600	Quasi-embed.	–25 ... +70°C	IP67	DW-AS-503-M18-002	C E H	
	M12	IO-Link	600	Quasi-embed.	–25 ... +70°C	IP67	DW-AS-503-M18-120	C E H	
	M12	IO-Link	500	Non-embed.	–25 ... +70°C	IP67	DW-AS-513-M18-002	C E H	
	M12	IO-Link	500	Non-embed.	–25 ... +70°C	IP67	DW-AS-513-M18-120	C E H	
PVC			200	Quasi-embed.	–25 ... +70°C	IP67	DW-AD-503-M30	E H	
	M12		200	Quasi-embed.	–25 ... +70°C	IP67	DW-AS-503-M30-002	C E H	
PVC			65	Non-embed.	–25 ... +70°C	IP67	DW-AD-513-M30	E H	
	M12		65	Non-embed.	–25 ... +70°C	IP67	DW-AS-513-M30-002	C E H	
PVC			200	Quasi-embed.	–25 ... +70°C	IP67	DW-AD-503-M30-120	E H	
	M12		200	Quasi-embed.	–25 ... +70°C	IP67	DW-AS-503-M30-120	C E H	
PVC			65	Non-embed.	–25 ... +70°C	IP67	DW-AD-513-M30-120	E H	
	M12		65	Non-embed.	–25 ... +70°C	IP67	DW-AS-513-M30-120	C E H	
	M8	IO-Link	5,000	Embed.	–25 ... +70°C	IP67	DW-AS-603-065-001	A E H	
PVC			3,000	Embed.	0 ... +60°C	IP67	DW-AD-643-065	E H	
PVC		IO-Link	5,000	Embed.	–25 ... +70°C	IP67	DW-AD-603-065	E H	
PVC		IO-Link	5,000	Embed.	–25 ... +70°C	IP67	DW-AD-623-065	E H	
	M8	IO-Link	5,000	Embed.	–25 ... +70°C	IP67	DW-AS-623-065-001	A E H	
PVC		IO-Link	3,500	Non-embed.	–25 ... +70°C	IP67	DW-AD-633-065	E H	
	M8	IO-Link	3,500	Non-embed.	–25 ... +70°C	IP67	DW-AS-633-065-001	A E H	
PVC		IO-Link	5,000	Embed.	–25 ... +70°C	IP67	DW-AD-603-065-121	E H	
PVC		IO-Link	5,000	Embed.	–25 ... +70°C	IP67	DW-AD-623-065-121	E H	
	M8	IO-Link	5,000	Embed.	–25 ... +70°C	IP67	DW-AS-603-065-123	A E H	
	M8	IO-Link	5,000	Embed.	–25 ... +70°C	IP67	DW-AS-623-065-123	A E H	
PVC		IO-Link	5,000	Embed.	–25 ... +70°C	IP67	DW-AD-603-065-122	E H	
PVC		IO-Link	5,000	Embed.	–25 ... +70°C	IP67	DW-AD-623-065-122	E H	
	M12	IO-Link	5,000	Embed.	–25 ... +70°C	IP67	DW-AS-603-065	C E H	
	M12	IO-Link	5,000	Embed.	–25 ... +70°C	IP67	DW-AS-623-065	C E H	
PVC		IO-Link	5,000	Embed.	–25 ... +70°C	IP67	DW-AD-603-065-120	E H	
PVC		IO-Link	5,000	Embed.	–25 ... +70°C	IP67	DW-AD-603-065-400	E H	

# INDUCTIVE SENSORS BASIC



## COMMON FEATURES

<b>Supply Voltage range</b>	10 ... 30 VDC
<b>Output</b>	PNP NO*

\* Other types available: PNP NC, NPN NC

\*\* Pigtail versions available

## OUTPUT

DW-A[x]-60[x]	
<b>Connection</b>	<b>Output</b>
[D] Cable [S] Connector [V] Pigtail	[1] NPN NO [3] PNP NO [2] NPN NC [4] PNP NC

Reference key on page 116

## ACCESSORIES

- A** Group A: M8 3-pin  
Sub-group: Field attachable connectors  
Sub-group: Distribution boxes
- B** Group B: M8 4-pin
- C** Group C: M12 4-pin  
Sub-group: Field attachable connectors  
Sub-group: Distribution boxes
- D** Group D: M12 AC/DC 3-pin
- E** Group E: Universal mounting brackets  
Sub-group: Mechanical stops
- F** Group F: Photoelectric mounting brackets
- G** Group G: Photoelectric reflectors
- H** Group H: Sensor tester

Go to page 298 for details

**CABLES**  
Cable lengths available:  
2 m, 5 m, 10 m  
other customised lengths possible

## FAMILY

## CLASSICS – SERIES 600

	OPERATING DISTANCE (mm)	HOUSING SIZE (mm)	HOUSING LENGTH (mm)	HOUSING MATERIAL
2		Ø 6.5	15	Stainless steel V2A
2		Ø 6.5	15	Stainless steel V2A
1.5		Ø 6.5	20	Stainless steel V2A
2		Ø 6.5	20	Stainless steel V2A
1.5		Ø 6.5	31	Stainless steel V2A
2		Ø 6.5	31	Stainless steel V2A
1.5		M8	36	Stainless steel V2A
2.5		M8	36	Stainless steel V2A
3		M8	35	Chrome-plated brass
3		M8	36	Chrome-plated brass
1.5		M8	35	Stainless steel V2A
2.5		M8	31	Stainless steel V2A
2		M8	35	Stainless steel V2A
2		M8	36	Stainless steel V2A
6		M8	31	Stainless steel V2A
6		M8	36	Stainless steel V2A
4		M8	36	Stainless steel V2A
4		M8	31	Stainless steel V2A
1.5		M8	22	Stainless steel V2A
2.5		M8	18	Stainless steel V2A
2		M8	22	Stainless steel V2A
1.5		M8	23	Stainless steel V2A
2.5		M8	23	Stainless steel V2A
2		M8	23	Stainless steel V2A
1.5		M8	30	Stainless steel V2A
2.5		M8	26	Stainless steel V2A
2		M8	30	Stainless steel V2A
2		M8	30	Stainless steel V2A
2		M8	45	Stainless steel V2A
2.5		M8	45	Stainless steel V2A



CABLE**	CONNECTOR**	IO-Link	SWITCHING FREQUENCY (Hz)	MOUNTING		AMBIENT TEMPERATURE	DEGREE OF PROTECTION	PART REFERENCE*	ACCESSORIES (SEE PAGE 40)
				EMB.	NON-EMB.				
			5,000	Embed.		-25 ... +70°C	IP67	DW-AD-623-065-120	
			5,000	Embed.		-25 ... +70°C	IP67	DW-AD-623-065-400	
			5,000	Embed.		-25 ... +70°C	IP67	DW-AS-603-065-129	
			5,000	Embed.		-25 ... +70°C	IP67	DW-AS-623-065-129	
			5,000	Embed.		-25 ... +70°C	IP67	DW-AS-603-065-124	
			5,000	Embed.		-25 ... +70°C	IP67	DW-AS-623-065-124	
			5,000	Embed.		-25 ... +70°C	IP67	DW-AS-603-M8-001	
			4,500	Non-embed.		-25 ... +70°C	IP67	DW-AS-613-M8-001	
			4,500	Embed.		0 ... +60°C	IP67	DW-AD-643-M8	
			4,500	Embed.		0 ... +60°C	IP67	DW-AS-643-M8-001	
			5,000	Embed.		-25 ... +70°C	IP67	DW-AD-603-M8	
			4,500	Non-embed.		-25 ... +70°C	IP67	DW-AD-613-M8	
			5,000	Embed.		-25 ... +70°C	IP67	DW-AD-623-M8	
			5,000	Embed.		-25 ... +70°C	IP67	DW-AS-623-M8-001	
			1,500	Non-embed.		0 ... +60°C	IP67	DW-AD-653-M8	
			1,500	Non-embed.		0 ... +60°C	IP67	DW-AS-653-M8-001	
			3,500	Non-embed.		-25 ... +70°C	IP67	DW-AS-633-M8-001	
			3,500	Non-embed.		-25 ... +70°C	IP67	DW-AD-633-M8	
			5,000	Embed.		-25 ... +70°C	IP67	DW-AD-603-M8-121	
			4,500	Non-embed.		-25 ... +70°C	IP67	DW-AD-613-M8-121	
			5,000	Embed.		-25 ... +70°C	IP67	DW-AD-623-M8-121	
			5,000	Embed.		-25 ... +70°C	IP67	DW-AS-603-M8-123	
			4,500	Non-embed.		-25 ... +70°C	IP67	DW-AS-613-M8-123	
			5,000	Embed.		-25 ... +70°C	IP67	DW-AS-623-M8-123	
			5,000	Embed.		-25 ... +70°C	IP67	DW-AD-603-M8-122	
			4,500	Non-embed.		-25 ... +70°C	IP67	DW-AD-613-M8-122	
			5,000	Embed.		-25 ... +70°C	IP67	DW-AD-623-M8-122	
			5,000	Embed.		-25 ... +70°C	IP67	DW-AD-623-M8-223	
			5,000	Embed.		-25 ... +70°C	IP67	DW-AS-623-M8	
			4,500	Non-embed.		-25 ... +70°C	IP67	DW-AS-613-M8	

# INDUCTIVE SENSORS BASIC



## COMMON FEATURES

<b>Supply Voltage range</b>	10 ... 30 VDC
<b>Output</b>	PNP NO*

\* Other types available: PNP NC, NPN NC

\*\* Pigtail versions available

## OUTPUT

DW-A[x]-60[x]	
<b>Connection</b>	<b>Output</b>
[D] Cable [S] Connector [V] Pigtail	[1] NPN NO [3] PNP NO [2] NPN NC [4] PNP NC

Reference key on page 116

## ACCESSORIES

- A** Group A: M8 3-pin  
Sub-group: Field attachable connectors  
Sub-group: Distribution boxes
- B** Group B: M8 4-pin
- C** Group C: M12 4-pin  
Sub-group: Field attachable connectors  
Sub-group: Distribution boxes
- D** Group D: M12 AC/DC 3-pin
- E** Group E: Universal mounting brackets  
Sub-group: Mechanical stops
- F** Group F: Photoelectric mounting brackets
- G** Group G: Photoelectric reflectors
- H** Group H: Sensor tester

Go to page 298 for details

**CABLES**  
Cable lengths available:  
2 m, 5 m, 10 m  
other customised lengths possible

## FAMILY

## CLASSICS – SERIES 600

OPERATING DISTANCE (mm)	HOUSING SIZE (mm)	HOUSING LENGTH (mm)	HOUSING MATERIAL
1.5	M8	45	Stainless steel V2A
1.5	M8	16	Stainless steel V2A
2	M8	16	Stainless steel V2A
1.5	M8	20	Stainless steel V2A
2	M8	20	Stainless steel V2A
2	M8	50	Stainless steel V2A
1.5	M8	31	Stainless steel V2A
2.5	M8	31	Stainless steel V2A
2	M8	31	Stainless steel V2A
1.5	8 × 8 (C8)	40	Zamak
1.5	8 × 8 (C8)	59	Zamak
2	8 × 8 (C8)	40	Zamak
2	8 × 8 (C8)	59	Zamak
2	M12	50	Nickel-plated brass
2	M12	60	Nickel-plated brass
4	M12	44.3	Nickel-plated brass
4	M12	60	Nickel-plated brass
4	M12	50	Nickel-plated brass
4	M12	60	Nickel-plated brass
4	M12	35	Nickel-plated brass
4	M12	45	Nickel-plated brass
2	M12	35	Nickel-plated brass
2	M12	45	Nickel-plated brass
4	M12	29.3	Nickel-plated brass
4	M12	44.7	Nickel-plated brass
8	M12	44.3	Nickel-plated brass
8	M12	60	Nickel-plated brass
8	M12	29.3	Nickel-plated brass
8	M12	44.7	Nickel-plated brass
5	M18	50	Nickel-plated brass



CABLE**	CONNECTOR**	IO-Link	SWITCHING FREQUENCY (Hz)	MOUNTING		AMBIENT TEMPERATURE	DEGREE OF PROTECTION	PART REFERENCE*	ACCESSORIES (SEE PAGE 42)
				EMB.	NON-EMB.				
	M12	IO-Link	5,000	Embed.		-25 ... +70°C	IP67	DW-AS-603-M8	C E H
		IO-Link	5,000	Embed.		-25 ... +70°C	IP67	DW-AD-603-M8-120	E H
		IO-Link	5,000	Embed.		-25 ... +70°C	IP67	DW-AD-623-M8-120	E H
	M8	IO-Link	5,000	Embed.		-25 ... +70°C	IP67	DW-AS-603-M8-129	A E H
	M8	IO-Link	5,000	Embed.		-25 ... +70°C	IP67	DW-AS-623-M8-129	A E H
	M12	IO-Link	5,000	Embed.		-25 ... +70°C	IP67	DW-AS-623-M8-193	C E H
	M8	IO-Link	5,000	Embed.		-25 ... +70°C	IP67	DW-AS-603-M8-124	A E H
	M8	IO-Link	4,500	Non-embed.		-25 ... +70°C	IP67	DW-AS-613-M8-124	A E H
	M8	IO-Link	5,000	Embed.		-25 ... +70°C	IP67	DW-AS-623-M8-124	A E H
		IO-Link	3,500	Embed.		-25 ... +70°C	IP67	DW-AD-603-C8	H
	M8	IO-Link	3,500	Embed.		-25 ... +70°C	IP67	DW-AS-603-C8-001	A H
		IO-Link	5,000	Embed.		-25 ... +70°C	IP67	DW-AD-623-C8	H
	M8	IO-Link	5,000	Embed.		-25 ... +70°C	IP67	DW-AS-623-C8-001	A H
		IO-Link	3,000	Embed.		-25 ... +70°C	IP67	DW-AD-603-M12	E H
	M12	IO-Link	3,000	Embed.		-25 ... +70°C	IP67	DW-AS-603-M12	C E H
		IO-Link	2,000	Non-embed.		-25 ... +70°C	IP67	DW-AD-613-M12	E H
	M12	IO-Link	2,000	Non-embed.		-25 ... +70°C	IP67	DW-AS-613-M12	C E H
		IO-Link	2,500	Embed.		-25 ... +70°C	IP67	DW-AD-623-M12	E H
	M12	IO-Link	2,500	Embed.		-25 ... +70°C	IP67	DW-AS-623-M12	C E H
		IO-Link	2,500	Embed.		-25 ... +70°C	IP67	DW-AD-623-M12-120	E H
	M12	IO-Link	2,500	Embed.		-25 ... +70°C	IP67	DW-AS-623-M12-120	C E H
		IO-Link	3,000	Embed.		-25 ... +70°C	IP67	DW-AD-603-M12-120	E H
	M12	IO-Link	3,000	Embed.		-25 ... +70°C	IP67	DW-AS-603-M12-120	C E H
		IO-Link	2,000	Non-embed.		-25 ... +70°C	IP67	DW-AD-613-M12-120	E H
	M12	IO-Link	2,000	Non-embed.		-25 ... +70°C	IP67	DW-AS-613-M12-120	C E H
		IO-Link	1,400	Non-embed.		-25 ... +70°C	IP67	DW-AD-633-M12	E H
	M12	IO-Link	1,400	Non-embed.		-25 ... +70°C	IP67	DW-AS-633-M12	C E H
		IO-Link	1,400	Non-embed.		-25 ... +70°C	IP67	DW-AD-633-M12-120	E H
	M12	IO-Link	1,400	Non-embed.		-25 ... +70°C	IP67	DW-AS-633-M12-120	C E H
		IO-Link	2,000	Embed.		-25 ... +70°C	IP67	DW-AD-603-M18	E H

# INDUCTIVE SENSORS BASIC



## COMMON FEATURES

<b>Supply Voltage range</b>	10 ... 30 VDC
<b>Output</b>	PNP NO*

\* Other types available: PNP NC, NPN NC

\*\* Pigtail versions available

## OUTPUT

DW-A[x]-60[x]	
<b>Connection</b>	<b>Output</b>
[D] Cable [S] Connector [V] Pigtail	[1] NPN NO [3] PNP NO [2] NPN NC [4] PNP NC

Reference key on page 116

## ACCESSORIES

- A** Group A: M8 3-pin  
Sub-group: Field attachable connectors  
Sub-group: Distribution boxes
- B** Group B: M8 4-pin
- C** Group C: M12 4-pin  
Sub-group: Field attachable connectors  
Sub-group: Distribution boxes
- D** Group D: M12 AC/DC 3-pin
- E** Group E: Universal mounting brackets  
Sub-group: Mechanical stops
- F** Group F: Photoelectric mounting brackets
- G** Group G: Photoelectric reflectors
- H** Group H: Sensor tester

Go to page 298 for details

**CABLES**  
Cable lengths available:  
2 m, 5 m, 10 m  
other customised lengths possible

## FAMILY

## CLASSICS – SERIES 600

	OPERATING DISTANCE (mm)	HOUSING SIZE (mm)	HOUSING LENGTH (mm)	HOUSING MATERIAL
5		M18	63.5	Nickel-plated brass
8		M18	40	Nickel-plated brass
8		M18	63.5	Nickel-plated brass
8		M18	50	Nickel-plated brass
8		M18	63.5	Nickel-plated brass
12		M18	40	Nickel-plated brass
12		M18	63.5	Nickel-plated brass
5		M18	35	Nickel-plated brass
8		M18	25	Nickel-plated brass
8		M18	35	Nickel-plated brass
8		M18	48.5	Nickel-plated brass
5		M18	48.5	Nickel-plated brass
8		M18	48.5	Nickel-plated brass
10		M30	50	Nickel-plated brass
10		M30	63.5	Nickel-plated brass
15		M30	40	Nickel-plated brass
15		M30	63.5	Nickel-plated brass
25		M30	63.5	Nickel-plated brass
25		M30	40	Nickel-plated brass
10		M30	35	Nickel-plated brass
15		M30	25	Chrome-plated brass
10		M30	48.5	Nickel-plated brass
15		M30	48.5	Nickel-plated brass
15		40 × 40 (C44)	67	PA GF
30		40 × 40 (C44)	67	PA GF
20		40 × 40 (C44)	67	PA GF
40		40 × 40 (C44)	67	PA GF



CABLE**	CONNECTOR**	IO-Link	SWITCHING FREQUENCY (Hz)	MOUNTING		AMBIENT TEMPERATURE	DEGREE OF PROTECTION	PART REFERENCE*	ACCESSORIES (SEE PAGE 44)
				EMB.	NON-EMB.				
	M12	IO-Link	2,000	Embed.		-25 ... +70°C	IP67	DW-AS-603-M18-002	C E H
PVC		IO-Link	2,000	Non-embed.		-25 ... +70°C	IP67	DW-AD-613-M18	E H
	M12	IO-Link	2,000	Non-embed.		-25 ... +70°C	IP67	DW-AS-613-M18-002	C E H
PVC		IO-Link	1,500	Embed.		-25 ... +70°C	IP67	DW-AD-623-M18	E H
	M12	IO-Link	1,500	Embed.		-25 ... +70°C	IP67	DW-AS-623-M18-002	C E H
PVC		IO-Link	500	Non-embed.		-25 ... +70°C	IP67	DW-AD-633-M18	E H
	M12	IO-Link	500	Non-embed.		-25 ... +70°C	IP67	DW-AS-633-M18-002	C E H
PVC		IO-Link	2,000	Embed.		-25 ... +70°C	IP67	DW-AD-603-M18-120	E H
PVC		IO-Link	2,000	Non-embed.		-25 ... +70°C	IP67	DW-AD-613-M18-120	E H
PVC		IO-Link	1,500	Embed.		-25 ... +70°C	IP67	DW-AD-623-M18-120	E H
	M12	IO-Link	1,500	Embed.		-25 ... +70°C	IP67	DW-AS-623-M18-120	C E H
	M12	IO-Link	2,000	Embed.		-25 ... +70°C	IP67	DW-AS-603-M18-120	C E H
	M12	IO-Link	2,000	Non-embed.		-25 ... +70°C	IP67	DW-AS-613-M18-120	C E H
PVC		IO-Link	1,200	Embed.		-25 ... +70°C	IP67	DW-AD-603-M30	E H
	M12	IO-Link	1,200	Embed.		-25 ... +70°C	IP67	DW-AS-603-M30-002	C E H
PVC		IO-Link	700	Non-embed.		-25 ... +70°C	IP67	DW-AD-613-M30	E H
	M12	IO-Link	700	Non-embed.		-25 ... +70°C	IP67	DW-AS-613-M30-002	C E H
	M12	IO-Link	200	Non-embed.		-25 ... +70°C	IP67	DW-AS-633-M30-002	C E H
PVC		IO-Link	200	Non-embed.		-25 ... +70°C	IP67	DW-AD-633-M30	E H
PVC		IO-Link	1,200	Embed.		-25 ... +70°C	IP67	DW-AD-603-M30-120	E H
PVC		IO-Link	700	Non-embed.		-25 ... +70°C	IP67	DW-AD-613-M30-120	E H
	M12	IO-Link	1,200	Embed.		-25 ... +70°C	IP67	DW-AS-603-M30-120	C E H
	M12	IO-Link	700	Non-embed.		-25 ... +70°C	IP67	DW-AS-613-M30-120	C E H
	M12	IO-Link	100	Embed.		-25 ... +85°C	IP68 / IP69K	DW-AS-60A-C44	C H
	M12	IO-Link	100	Non-embed.		-25 ... +85°C	IP68 / IP69K	DW-AS-61A-C44	C H
	M12	IO-Link	100	Embed.		-25 ... +85°C	IP68 / IP69K	DW-AS-62A-C44	C H
	M12	IO-Link	100	Non-embed.		-25 ... +85°C	IP68 / IP69K	DW-AS-63A-C44	C H

# INDUCTIVE SENSORS BASIC



## COMMON FEATURES

<b>Supply Voltage range</b>	10 ... 30 VDC
<b>Output</b>	PNP NO*

\* Other types available: PNP NC, NPN NC

\*\* Pigtail versions available

## OUTPUT

DW-A[x]-70[x]	
<b>Connection</b>	<b>Output</b>
[D] Cable [S] Connector [V] Pigtail	[1] NPN NO [3] PNP NO [2] NPN NC [4] PNP NC

Reference key on page 116

## ACCESSORIES

- A** Group A: M8 3-pin  
Sub-group: Field attachable connectors  
Sub-group: Distribution boxes
- B** Group B: M8 4-pin
- C** Group C: M12 4-pin  
Sub-group: Field attachable connectors  
Sub-group: Distribution boxes
- D** Group D: M12 AC/DC 3-pin
- E** Group E: Universal mounting brackets  
Sub-group: Mechanical stops
- F** Group F: Photoelectric mounting brackets
- G** Group G: Photoelectric reflectors
- H** Group H: Sensor tester

Go to page 298 for details

**CABLES**  
Cable lengths available:  
2 m, 5 m, 10 m  
other customised lengths possible

FAMILY	OPERATING DISTANCE (mm)	HOUSING SIZE (mm)	HOUSING LENGTH (mm)	HOUSING MATERIAL
FULL INOX – SERIES 700	2	M8	60	Stainless steel V2A
	2	M8	45	Stainless steel V2A
	3	M12	60	Stainless steel V2A
	3	M12	50	Stainless steel V2A
	3	M12	60	Stainless steel V2A
	5	M18	63.5	Stainless steel V2A
	5	M18	50	Stainless steel V2A
	10	M30	63.5	Stainless steel V2A
	10	M30	50	Stainless steel V2A

FULL INOX – SERIES 700





CABLE **	CONNECTOR **	IO-Link	SWITCHING FREQUENCY (Hz)	MOUNTING		AMBIENT TEMPERATURE	DEGREE OF PROTECTION	PART REFERENCE*	ACCESSORIES (SEE PAGE 46)
				EMB. 	NON-EMB. 				
	M8	IO-Link	100	Embed.		-25 ... +70°C	IP68 / IP69K	DW-AS-703-M8-001-BAS	A E H
PUR		IO-Link	100	Embed.		-25 ... +70°C	IP68 / IP69K	DW-AD-703-M8-BAS	E H
	M12	IO-Link	100	Embed.		-25 ... +70°C	IP68 / IP69K	DW-AS-703-M12-BAS	C E H
PUR		IO-Link	100	Embed.		-25 ... +70°C	IP68 / IP69K	DW-AD-703-M12-BAS	E H
	M12	IO-Link	100	Embed.		-25 ... +70°C	IP68 / IP69K	DW-AS-703-M12-120-BAS	C E H
	M12	IO-Link	100	Embed.		-25 ... +70°C	IP68 / IP69K	DW-AS-703-M18-BAS	C E H
PUR		IO-Link	100	Embed.		-25 ... +70°C	IP68 / IP69K	DW-AD-703-M18-BAS	E H
	M12	IO-Link	50	Embed.		-25 ... +70°C	IP68 / IP69K	DW-AS-703-M30-BAS	C E H
PUR		IO-Link	50	Embed.		-25 ... +70°C	IP68 / IP69K	DW-AD-703-M30-BAS	E H





## APPLICATION

### **Miniature inductive sensors ensure gripper jaws are fully open before initiating automated assembly**

During automated assembly of delicate components by a multi-finger gripper, impacts between gripper fingers and fragile components cause costly handling errors and damage. To prevent this, the jaws must be fully open before the gripper descends to pick up a component. Miniature inductive sensors with a diameter of just 3 mm are mounted above each gripper finger, detecting the open position and providing reliable confirmation that the jaws are fully open before picking is initiated.

## INDUSTRIES

Machine tool, vehicles, assembly, automation, robotics, micromechanics, special purpose machines



*Robotics for pick-and-place*



*Linear drive technology*



*Machine tool position control*



*Textile spinning machine automation*

# MINIATURE INDUCTIVE SENSORS

## FULL FUNCTIONALITY, SMALLEST SIZE

Size is often a critical constraint when selecting sensors for position- or presence-sensing. The Contrinex **Miniature** range, which includes the smallest self-contained inductive sensors on the market, meets this constraint without compromising on functionality.

### KEY ADVANTAGES

#### Classics, Extra Distance and Full Inox

- ✓ High quality ASIC sensors with  IO-Link interface
- ✓ Smallest self-contained inductive sensors on the market
- ✓ Outstanding temperature stability from  $-25^{\circ}\text{C}$  ( $-13^{\circ}\text{F}$ ) to  $+70^{\circ}\text{C}$  ( $+158^{\circ}\text{F}$ ) or  $+85^{\circ}\text{C}$  ( $+185^{\circ}\text{F}$ ) for Full Inox types
- ✓ High switching frequency up to 8,000 Hz
- ✓ Electronics vacuum potted for optimum long-term reliability under high stress

#### Full Inox

- ✓ Extremely robust one-piece stainless-steel housing
- ✓ Corrosion resistant
- ✓ Water resistant
- ✓ Pressure resistant up to 120 bar (1,740 psi)



## PRODUCT OVERVIEW

		 IO-Link				
Housing size mm		Ø3	M4	Ø4	M5	C5
s <sub>n</sub> mm	Extra Distance	–	–	2.5	2.5	–
	Classics	0.6 ... 1	0.6 ... 1	0.8 ... 1.5	0.8 ... 1.5	0.8 ... 1.5
	Full Inox	–	–	3	3	–

## ACCESSORIES

Go to page 298 to see all the accessories

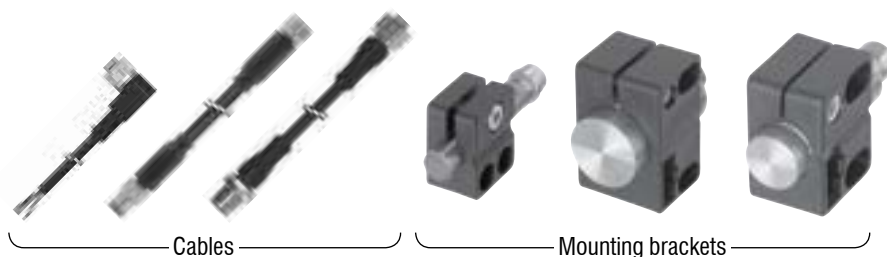

Cables

Mounting brackets

# INDUCTIVE SENSORS MINIATURE



## COMMON FEATURES

<b>Supply Voltage range</b>	10 ... 30 VDC
<b>Output</b>	PNP NO*

\* Other types available: PNP NC, NPN NC

\*\* 2 m length if not specified

## OUTPUT

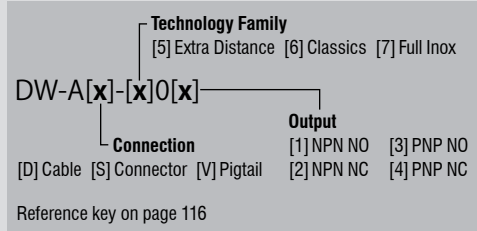

## ACCESSORIES

- A** Group A: M8 3-pin  
Sub-group: Field attachable connectors  
Sub-group: Distribution boxes
- B** Group B: M8 4-pin
- C** Group C: M12 4-pin  
Sub-group: Field attachable connectors  
Sub-group: Distribution boxes
- D** Group D: M12 AC/DC 3-pin
- E** Group E: Universal mounting brackets  
Sub-group: Mechanical stops
- F** Group F: Photoelectric mounting brackets
- G** Group G: Photoelectric reflectors
- H** Group H: Sensor tester

Go to page 298 for details

**CABLES**  
Cable lengths available:  
2 m, 5 m, 10 m  
other customised lengths possible

FAMILY	OPERATING DISTANCE (mm)	HOUSING SIZE (mm)	HOUSING LENGTH (mm)	HOUSING MATERIAL
<b>EXTRA DISTANCE SERIES 500</b>	2.5	Ø 4	25	Nickel silver
	2.5	Ø 4	38	Nickel silver
	2.5	M5	25	Nickel silver
	2.5	M5	38	Nickel silver

<b>CLASSICS – SERIES 600</b>	1	Ø 3	12	Stainless steel V2A
	0.6	Ø 3	22	Stainless steel V2A
	1	Ø 3	22	Stainless steel V2A
	0.6	Ø 3	22	Stainless steel V2A
	1	Ø 3	22	Stainless steel V2A
	1	M4	12	Stainless steel V2A
	0.6	M4	22	Stainless steel V2A
	1	M4	22	Stainless steel V2A
	0.6	M4	22	Stainless steel V2A
	1	M4	22	Stainless steel V2A
	0.8	Ø 4	25	Stainless steel V2A
	1.5	Ø 4	25	Stainless steel V2A
	0.8	Ø 4	38	Stainless steel V2A
	1.5	Ø 4	38	Stainless steel V2A
	0.8	Ø 4	25	Stainless steel V2A
	1.5	Ø 4	25	Stainless steel V2A
	0.8	M5	25	Stainless steel V2A
	1.5	M5	25	Stainless steel V2A
	0.8	M5	38	Stainless steel V2A
	1.5	M5	38	Stainless steel V2A
	0.8	M5	25	Stainless steel V2A
	1.5	M5	25	Stainless steel V2A



CABLE**	CONNECTOR	IO-Link	SWITCHING FREQUENCY (Hz)	MOUNTING		AMBIENT TEMPERATURE	DEGREE OF PROTECTION	PART REFERENCE*	ACCESSORIES (SEE PAGE 50)
				EMB.	NON-EMB.				
PVC		IO-Link	800	Quasi-embed.		-25 ... +70°C	IP67	DW-AD-503-04	E H
	M8	IO-Link	800	Quasi-embed.		-25 ... +70°C	IP67	DW-AS-503-04	A E H
PVC		IO-Link	800	Quasi-embed.		-25 ... +70°C	IP67	DW-AD-503-M5	E H
	M8	IO-Link	800	Quasi-embed.		-25 ... +70°C	IP67	DW-AS-503-M5	A E H
PUR		IO-Link	8,000	Embed.		-25 ... +70°C	IP67	DW-AD-623-03-960	E H
PUR		IO-Link	5,000	Embed.		-25 ... +70°C	IP67	DW-AD-603-03	E H
PUR		IO-Link	3,000	Embed.		-25 ... +70°C	IP67	DW-AD-623-03	E H
0.2 m PUR	M8	IO-Link	5,000	Embed.		-25 ... +70°C	IP67	DW-AV-603-03-276	A E H
0.2 m PUR	M8	IO-Link	3,000	Embed.		-25 ... +70°C	IP67	DW-AV-623-03-276	A E H
PUR		IO-Link	8,000	Embed.		-25 ... +70°C	IP67	DW-AD-623-M4-960	E H
PUR		IO-Link	5,000	Embed.		-25 ... +70°C	IP67	DW-AD-603-M4	E H
PUR		IO-Link	3,000	Embed.		-25 ... +70°C	IP67	DW-AD-623-M4	E H
0.2 m PUR	M8	IO-Link	5,000	Embed.		-25 ... +70°C	IP67	DW-AV-603-M4-276	A E H
0.2 m PUR	M8	IO-Link	3,000	Embed.		-25 ... +70°C	IP67	DW-AV-623-M4-276	A E H
PVC		IO-Link	5,000	Embed.		-25 ... +70°C	IP67	DW-AD-603-04	E H
PVC		IO-Link	3,000	Embed.		-25 ... +70°C	IP67	DW-AD-623-04	E H
	M8	IO-Link	5,000	Embed.		-25 ... +70°C	IP67	DW-AS-603-04	A E H
	M8	IO-Link	3,000	Embed.		-25 ... +70°C	IP67	DW-AS-623-04	A E H
0.2 m PUR	M8	IO-Link	5,000	Embed.		-25 ... +70°C	IP67	DW-AV-603-04-276	A E H
0.2 m PUR	M8	IO-Link	3,000	Embed.		-25 ... +70°C	IP67	DW-AV-623-04-276	A E H
PVC		IO-Link	5,000	Embed.		-25 ... +70°C	IP67	DW-AD-603-M5	E H
PVC		IO-Link	3,000	Embed.		-25 ... +70°C	IP67	DW-AD-623-M5	E H
	M8	IO-Link	5,000	Embed.		-25 ... +70°C	IP67	DW-AS-603-M5	A E H
	M8	IO-Link	3,000	Embed.		-25 ... +70°C	IP67	DW-AS-623-M5	A E H
0.2 m PUR	M8	IO-Link	5,000	Embed.		-25 ... +70°C	IP67	DW-AV-603-M5-276	A E H
0.2 m PUR	M8	IO-Link	3,000	Embed.		-25 ... +70°C	IP67	DW-AV-623-M5-276	A E H

# INDUCTIVE SENSORS MINIATURE



## COMMON FEATURES

<b>Supply Voltage range</b>	10 ... 30 VDC
<b>Output</b>	PNP NO*

\* Other types available: PNP NC, NPN NC

\*\* 2 m length if not specified

## OUTPUT

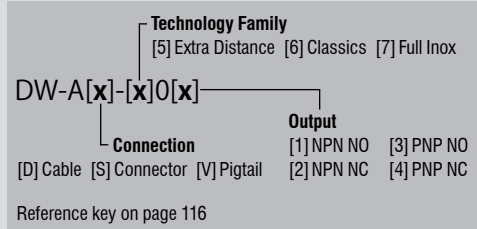

## ACCESSORIES

- A** Group A: M8 3-pin  
Sub-group: Field attachable connectors  
Sub-group: Distribution boxes
- B** Group B: M8 4-pin
- C** Group C: M12 4-pin  
Sub-group: Field attachable connectors  
Sub-group: Distribution boxes
- D** Group D: M12 AC/DC 3-pin
- E** Group E: Universal mounting brackets  
Sub-group: Mechanical stops
- F** Group F: Photoelectric mounting brackets
- G** Group G: Photoelectric reflectors
- H** Group H: Sensor tester

Go to page 298 for details

**CABLES**  
Cable lengths available:  
2 m, 5 m, 10 m  
other customised lengths possible

FAMILY	OPERATING DISTANCE (mm)	HOUSING SIZE (mm)	HOUSING LENGTH (mm)	HOUSING MATERIAL
<b>CLASSICS SERIES 600</b>	0.8	5 × 5 (C5)	25	Nickel-chrome-plated brass
	1.5	5 × 5 (C5)	25	Nickel-chrome-plated brass
	0.8	5 × 5 (C5)	25	Nickel-chrome-plated brass
	1.5	5 × 5 (C5)	25	Nickel-chrome-plated brass

<b>FULL INOX SERIES 700</b>	3	∅ 4	30	Stainless steel V2A
	3	∅ 4	30	Stainless steel V2A
	3	M5	30	Stainless steel V2A
	3	M5	30	Stainless steel V2A





CABLE**	CONNECTOR	IO-Link	SWITCHING FREQUENCY (Hz)	MOUNTING		AMBIENT TEMPERATURE	DEGREE OF PROTECTION	PART REFERENCE*	ACCESSORIES (SEE PAGE 52)
				EMB.	NON-EMB.				
PUR		IO-Link	5,000	Embed.		-25 ... +70°C	IP67	DW-AD-603-C5	H
PUR		IO-Link	3,000	Embed.		-25 ... +70°C	IP67	DW-AD-623-C5	H
0.2 m PUR	M8	IO-Link	5,000	Embed.		-25 ... +70°C	IP67	DW-AV-603-C5-276	A H
0.2 m PUR	M8	IO-Link	3,000	Embed.		-25 ... +70°C	IP67	DW-AV-623-C5-276	A H

PUR		IO-Link	1,200	Non-embed.		-25 ... +85°C	IP67	DW-AD-713-04	E H
0.2 m PUR	M8	IO-Link	1,200	Non-embed.		-25 ... +85°C	IP67	DW-AV-713-04-276	A E H
PUR		IO-Link	1,200	Non-embed.		-25 ... +85°C	IP67	DW-AD-713-M5	E H
0.2 m PUR	M8	IO-Link	1,200	Non-embed.		-25 ... +85°C	IP67	DW-AV-713-M5-276	A E H





## APPLICATION

### **Rugged inductive sensors confirm engagement of safety interlocks on hooklift trucks**

A hooklift truck utilizes a hydraulic system for loading and unloading a demountable container. Once the container is correctly positioned on the vehicle's load bed, interlocks engage with its base, securing it in position. Rugged sensor systems detect full engagement of the interlocks, ensuring the truck is safely loaded prior to driving away. Sensors must be mechanically robust and withstand harsh outdoor conditions.

## INDUSTRIES

Automotive production and supply, machine tool, maritime, vehicles, packaging, logistics, materials handling



*Tools for machining metal components*



*Mixing, lifting and tipping mechanisms*



*Packaging systems*



*Automotive part sensing*

# EXTREME INDUCTIVE SENSORS

## EXTREME DURABILITY IN HARSH ENVIRONMENTS

Only the toughest sensors survive the most extreme environments. Thanks to one-piece stainless-steel (V2A/AISI 303) construction and a hermetically sealed cable entry, **Extreme** sensors are corrosion-resistant, impervious to oil, and pressure-resistant to **100 bar**. Rugged, reliable and highly accurate, the **Extreme** range is at home in the most challenging circumstances.

### KEY ADVANTAGES

- ✓ Mechanically and chemically extremely robust
- ✓ Corrosion resistant
- ✓ IP68 and IP69K, water resistant
- ✓ Pressure resistant up to 100 bar (1,451 psi)
- ✓  IO-Link



### PRODUCT OVERVIEW

 IO-Link					
Housing size mm	M8	M12	M18	M30	C23
Full Inox (s <sub>n</sub> mm)	3 ... 6	2 ... 15	5 ... 20	10 ... 40	7

### ACCESSORIES

Go to page 298 to see all the accessories

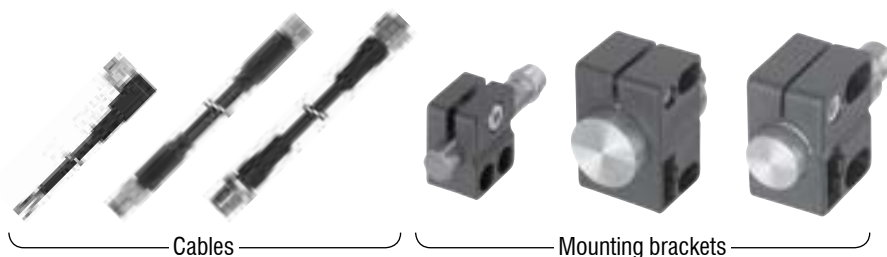

# INDUCTIVE SENSORS EXTREME



## COMMON FEATURES

<b>Supply Voltage range</b>	10 ... 30 VDC
<b>Output</b>	PNP NO*

\* Other types available: PNP NC, NPN NC

\*\* Pigtail versions available

## OUTPUT

DW-A[x]-70[x]		<b>Output</b>
<b>Connection</b>	[1] NPN NO [3] PNP NO	
[D] Cable [S] Connector [V] Pigtail	[2] NPN NC [4] PNP NC	

Reference key on page 116

## ACCESSORIES

- A** Group A: M8 3-pin  
Sub-group: Field attachable connectors  
Sub-group: Distribution boxes
- B** Group B: M8 4-pin
- C** Group C: M12 4-pin  
Sub-group: Field attachable connectors  
Sub-group: Distribution boxes
- D** Group D: M12 AC/DC 3-pin
- E** Group E: Universal mounting brackets  
Sub-group: Mechanical stops
- F** Group F: Photoelectric mounting brackets
- G** Group G: Photoelectric reflectors
- H** Group H: Sensor tester

Go to page 298 for details

**CABLES**  
Cable lengths available:  
2 m, 5 m, 10 m  
other customised lengths possible

## FAMILY

FULL INOX – SERIES 700

	OPERATING DISTANCE (mm)	HOUSING SIZE (mm)	HOUSING LENGTH (mm)	HOUSING MATERIAL
3		M8	45	Stainless steel V2A
3		M8	60	Stainless steel V2A
6		M8	45	Stainless steel V2A
6		M8	60	Stainless steel V2A
3		M8	66	Stainless steel V2A
6		M8	66	Stainless steel V2A
6		M12	50	Stainless steel V2A
6		M12	60	Stainless steel V2A
10		M12	50	Stainless steel V2A
10		M12	60	Stainless steel V2A
2		M12	50	Stainless steel V2A
2		M12	60	Stainless steel V2A
4		M12	50	Stainless steel V2A
4		M12	60	Stainless steel V2A
15		M12	60	Stainless steel V2A
15		M12	50	Stainless steel V2A
15		M12	60	Stainless steel V2A
6		M12	60	Stainless steel V2A
10		M18	50	Stainless steel V2A
10		M18	63.5	Stainless steel V2A
20		M18	50	Stainless steel V2A
20		M18	63.5	Stainless steel V2A
5		M18	50	Stainless steel V2A
5		M18	63.5	Stainless steel V2A
8		M18	63.5	Stainless steel V2A
10		M18	35	Stainless steel V2A
10		M18	48.5	Stainless steel V2A
10		M18	35	Stainless steel V2A
20		M30	50	Stainless steel V2A
20		M30	63.5	Stainless steel V2A



CABLE**	CONNECTOR**	IO-Link	SWITCHING FREQUENCY (Hz)	MOUNTING		AMBIENT TEMPERATURE	DEGREE OF PROTECTION	PART REFERENCE*	ACCESSORIES (SEE PAGE 56)
				EMB.	NON-EMB.				
PUR		IO-Link	1,200	Embed.		-25 ... +85°C	IP68 / IP69K	DW-AD-703-M8	E H
	M8	IO-Link	1,200	Embed.		-25 ... +85°C	IP68 / IP69K	DW-AS-703-M8-001	A E H
PUR		IO-Link	700	Non-embed.		-25 ... +85°C	IP68 / IP69K	DW-AD-713-M8	E H
	M8	IO-Link	700	Non-embed.		-25 ... +85°C	IP68 / IP69K	DW-AS-713-M8-001	A E H
	M12	IO-Link	1,200	Embed.		-25 ... +85°C	IP68 / IP69K	DW-AS-703-M8	C E H
	M12	IO-Link	700	Non-embed.		-25 ... +85°C	IP68 / IP69K	DW-AS-713-M8	C E H
PUR		IO-Link	600	Embed.		-25 ... +85°C	IP68 / IP69K	DW-AD-703-M12	E H
	M12	IO-Link	600	Embed.		-25 ... +85°C	IP68 / IP69K	DW-AS-703-M12	C E H
PUR		IO-Link	400	Non-embed.		-25 ... +85°C	IP68 / IP69K	DW-AD-713-M12	E H
	M12	IO-Link	400	Non-embed.		-25 ... +85°C	IP68 / IP69K	DW-AS-713-M12	C E H
PUR		IO-Link	900	Embed.		-25 ... +85°C	IP68 / IP69K	DW-AD-703-M12-303	E H
	M12	IO-Link	900	Embed.		-25 ... +85°C	IP68 / IP69K	DW-AS-703-M12-303	C E H
PUR		IO-Link	600	Non-embed.		-25 ... +85°C	IP68 / IP69K	DW-AD-713-M12-303	E H
	M12	IO-Link	600	Non-embed.		-25 ... +85°C	IP68 / IP69K	DW-AS-713-M12-303	C E H
	M12	IO-Link	300	Non-embed.		-25 ... +85°C	IP68 / IP69K	DW-AS-733-M12	C E H
PUR		IO-Link	300	Non-embed.		-25 ... +85°C	IP68 / IP69K	DW-AD-733-M12	E H
	M12	IO-Link	300	Non-embed.		-25 ... +85°C	IP68 / IP69K	DW-AS-73A-M12	C E H
	M12	IO-Link	600	Embed.		-25 ... +85°C	IP68 / IP69K	DW-AS-70A-M12	C E H
PUR		IO-Link	200	Embed.		-25 ... +85°C	IP68 / IP69K	DW-AD-703-M18	E H
	M12	IO-Link	200	Embed.		-25 ... +85°C	IP68 / IP69K	DW-AS-703-M18-002	C E H
PUR		IO-Link	200	Non-embed.		-25 ... +85°C	IP68 / IP69K	DW-AD-713-M18	E H
	M12	IO-Link	200	Non-embed.		-25 ... +85°C	IP68 / IP69K	DW-AS-713-M18-002	C E H
PUR		IO-Link	500	Embed.		-25 ... +85°C	IP68 / IP69K	DW-AD-703-M18-303	E H
	M12	IO-Link	500	Embed.		-25 ... +85°C	IP68 / IP69K	DW-AS-703-M18-303	C E H
	M12	IO-Link	400	Non-embed.		-25 ... +85°C	IP68 / IP69K	DW-AS-713-M18-303	C E H
PUR		IO-Link	200	Embed.		-25 ... +85°C	IP68 / IP69K	DW-AD-703-M18-120	E H
	M12	IO-Link	200	Embed.		-25 ... +85°C	IP68 / IP69K	DW-AS-703-M18-120	C E H
PUR		IO-Link	200	Embed.		-25 ... +85°C	IP68 / IP69K	DW-AD-703-M18-226	E H
PUR		IO-Link	125	Embed.		-25 ... +85°C	IP68 / IP69K	DW-AD-703-M30	E H
	M12	IO-Link	125	Embed.		-25 ... +85°C	IP68 / IP69K	DW-AS-703-M30-002	C E H

# INDUCTIVE SENSORS EXTREME



## COMMON FEATURES

<b>Supply Voltage range</b>	10 ... 30 VDC
<b>Output</b>	PNP NO*

\* Other types available: PNP NC, NPN NC

\*\* Pigtail versions available

## OUTPUT

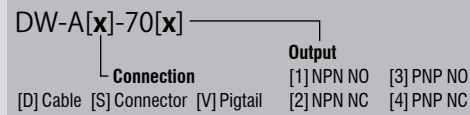

Reference key on page 116

## ACCESSORIES

- A** Group A: M8 3-pin  
Sub-group: Field attachable connectors  
Sub-group: Distribution boxes
- B** Group B: M8 4-pin
- C** Group C: M12 4-pin  
Sub-group: Field attachable connectors  
Sub-group: Distribution boxes
- D** Group D: M12 AC/DC 3-pin
- E** Group E: Universal mounting brackets  
Sub-group: Mechanical stops
- F** Group F: Photoelectric mounting brackets
- G** Group G: Photoelectric reflectors
- H** Group H: Sensor tester

Go to page 298 for details



## CABLES

Cable lengths available:  
2 m, 5 m, 10 m  
other customised lengths possible

## FAMILY

OPERATING DISTANCE (mm)	HOUSING SIZE (mm)	HOUSING LENGTH (mm)	HOUSING MATERIAL
40	M30	50	Stainless steel V2A
40	M30	63.5	Stainless steel V2A
10	M30	50	Stainless steel V2A
10	M30	63.5	Stainless steel V2A
7	32 × 20 (C23)	8	Stainless steel V2A

FULL INOX – SERIES 700





CABLE **	CONNECTOR **	IO-Link	SWITCHING FREQUENCY (Hz)	MOUNTING		AMBIENT TEMPERATURE	DEGREE OF PROTECTION	PART REFERENCE*	ACCESSORIES (SEE PAGE 58)
				EMB.	NON-EMB.				
PUR		IO-Link	90	Non-embed.		-25 ... +85°C	IP68 / IP69K	<b>DW-AD-713-M30</b>	
	M12	IO-Link	90	Non-embed.		-25 ... +85°C	IP68 / IP69K	<b>DW-AS-713-M30-002</b>	
PUR		IO-Link	250	Embed.		-25 ... +85°C	IP68 / IP69K	<b>DW-AD-703-M30-303</b>	
	M12	IO-Link	250	Embed.		-25 ... +85°C	IP68 / IP69K	<b>DW-AS-703-M30-303</b>	
PVC		IO-Link	180	Embed.		-25 ... +85°C	IP68 / IP69K	<b>DW-AD-703-C23</b>	



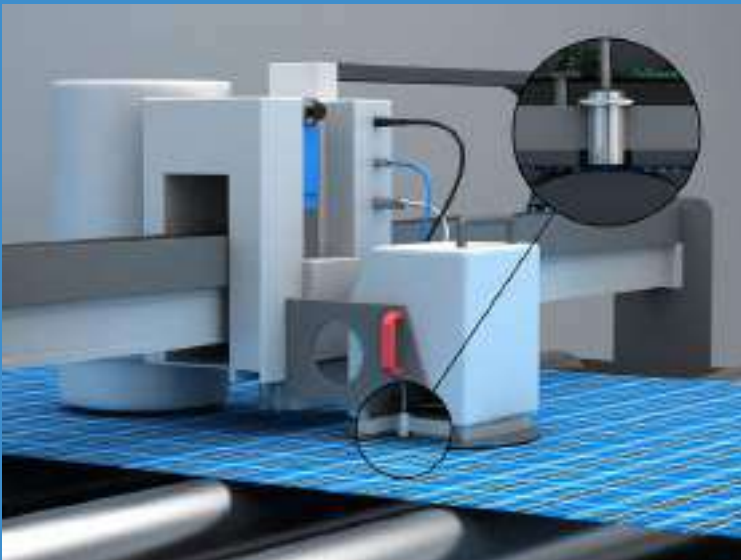

## APPLICATION

### High-resolution analog inductive sensor measures thickness of moving textile webs

A specialized textile-testing machine measures the thickness of a moving textile web continuously and in real time. As the web passes over a roller, a precision analog inductive sensor, positioned directly above the roller, rests lightly on the top of the web. By sensing the distance through the material to the roller, the sensor measures the thickness of the web.

## INDUSTRIES

Machine tool, packaging, logistics, materials handling, textile, printing, metal sorting, quality control, vibration monitoring



*Distance monitoring for position control*



*Drive-belt tension monitoring*



*Logistics systems*



*Machine tools*

# ANALOG OUTPUT INDUCTIVE SENSORS

## ANALOG OUTPUT FOR DISTANCE CONTROL

Best-in-class temperature stability and a measurement range of zero to 40 mm make the Contrinex **Analog Output** sensor range ideally suited for measuring linear, angular and rotational position. With detection accuracy in the micron range and the best long-range sensing capability on the market, these sensors offer world-class performance with an attractive total cost of ownership.

### KEY ADVANTAGES

- ✓ Longest sensing ranges
- ✓ Best temperature stability
- ✓ Excellent repeat accuracy
- ✓ Resolution in  $\mu\text{m}$  range
- ✓ Current or voltage output



### PRODUCT OVERVIEW

Housing size mm	C8	M8	M12	M18	M30
Extra Distance ( $s_n$ mm)	0 ... 4	0 ... 4	0 ... 6	0 ... 20	0 ... 40

### ACCESSORIES

Go to page 298 to see all the accessories

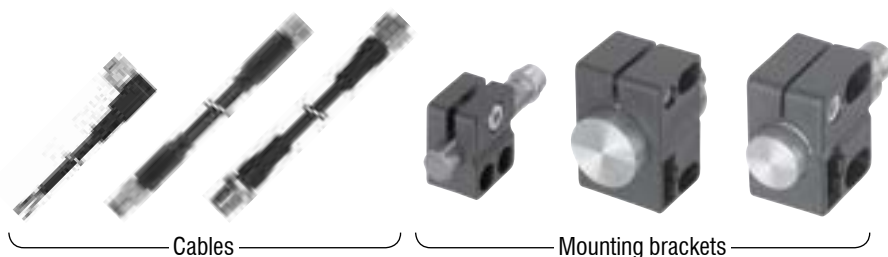

# INDUCTIVE SENSORS ANALOG OUTPUT



## COMMON FEATURE

**Supply Voltage range** 15 ... 30 VDC

## OUTPUT

DW-A[x]-50[x]  
 Connection: [D] Cable [S] Connector  
 Output: [9] Analog

Reference key on page 116

## ACCESSORIES













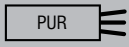

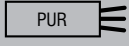
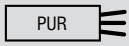

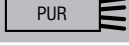
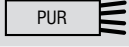
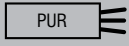
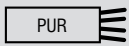

- A** Group A: M8 3-pin  
Sub-group: Field attachable connectors  
Sub-group: Distribution boxes
- B** Group B: M8 4-pin
- C** Group C: M12 4-pin  
Sub-group: Field attachable connectors  
Sub-group: Distribution boxes
- D** Group D: M12 AC/DC 3-pin
- E** Group E: Universal mounting brackets  
Sub-group: Mechanical stops
- F** Group F: Photoelectric mounting brackets
- G** Group G: Photoelectric reflectors
- H** Group H: Sensor tester

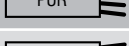
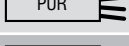
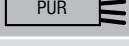
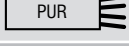
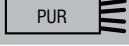
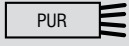
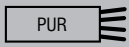
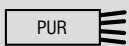
Go to page 298 for details

**CABLES**  
 Cable lengths available:  
 2 m, 5 m, 10 m  
 other customised lengths possible

FAMILY	OPERATING DISTANCE (mm)	HOUSING SIZE (mm)	HOUSING LENGTH (mm)	HOUSING MATERIAL
EXTRA DISTANCE – SERIES 500	4	8 × 8 (C8)	50	Chrome-plated brass
	4	8 × 8 (C8)	59	Chrome-plated brass
	4	M8	45	Chrome-plated brass
	4	M8	45	Chrome-plated brass
	4	M8	60	Chrome-plated brass
	4	M8	60	Chrome-plated brass
	6	M12	50	Chrome-plated brass
	6	M12	35	Chrome-plated brass
	6	M12	35	Chrome-plated brass
	6	M12	50	Chrome-plated brass
	6	M12	60	Chrome-plated brass
	6	M12	45	Chrome-plated brass
	6	M12	45	Chrome-plated brass
	6	M12	60	Chrome-plated brass
	10	M18	50	Chrome-plated brass
	10	M18	35	Chrome-plated brass
	10	M18	35	Chrome-plated brass
	10	M18	50	Chrome-plated brass
	20	M18	40	Chrome-plated brass
	20	M18	25	Chrome-plated brass
	20	M18	25	Chrome-plated brass
	20	M18	40	Chrome-plated brass
	10	M18	63.5	Chrome-plated brass
	10	M18	48.5	Chrome-plated brass
	10	M18	48.5	Chrome-plated brass
	10	M18	63.5	Chrome-plated brass
	20	M18	63.5	Chrome-plated brass
	20	M18	48.5	Chrome-plated brass
	20	M18	48.5	Chrome-plated brass
	20	M18	63.5	Chrome-plated brass



CABLE	CONNECTOR	OUTPUT 1	OUTPUT 2	MOUNTING		AMBIENT TEMPERATURE	DEGREE OF PROTECTION	PART REFERENCE	ACCESSORIES (SEE PAGE 62)
				EMB. 	NON-EMB. 				
		0 ... 10 V	–	Quasi-embed.	–25 ... +70°C	IP67	<b>DW-AD-509-C8-390</b>	<b>H</b>	
	 M8	0 ... 10 V	–	Quasi-embed.	–25 ... +70°C	IP67	<b>DW-AS-509-C8-390</b>	<b>A H</b>	
		0 ... 5 V	–	Quasi-embed.	–25 ... +70°C	IP67	<b>DW-AD-509-M8</b>	<b>E H</b>	
		0 ... 10 V	–	Quasi-embed.	–25 ... +70°C	IP67	<b>DW-AD-509-M8-390</b>	<b>E H</b>	
	 M8	0 ... 5 V	–	Quasi-embed.	–25 ... +70°C	IP67	<b>DW-AS-509-M8-001</b>	<b>A E H</b>	
	 M8	0 ... 10 V	–	Quasi-embed.	–25 ... +70°C	IP67	<b>DW-AS-509-M8-390</b>	<b>A E H</b>	
		0 ... 5 V	1 ... 5 mA	Quasi-embed.	–25 ... +70°C	IP67	<b>DW-AD-509-M12</b>	<b>E H</b>	
		0 ... 5 V	1 ... 5 mA	Quasi-embed.	–25 ... +70°C	IP67	<b>DW-AD-509-M12-120</b>	<b>E H</b>	
		0 ... 10 V	–	Quasi-embed.	–25 ... +70°C	IP67	<b>DW-AD-509-M12-320</b>	<b>E H</b>	
		0 ... 10 V	4 ... 20 mA	Quasi-embed.	–25 ... +70°C	IP67	<b>DW-AD-509-M12-390</b>	<b>C E H</b>	
	 M12	0 ... 5 V	1 ... 5 mA	Quasi-embed.	–25 ... +70°C	IP67	<b>DW-AS-509-M12</b>	<b>E H</b>	
	 M12	0 ... 5 V	1 ... 5 mA	Quasi-embed.	–25 ... +70°C	IP67	<b>DW-AS-509-M12-120</b>	<b>C E H</b>	
	 M12	0 ... 10 V	–	Quasi-embed.	–25 ... +70°C	IP67	<b>DW-AS-509-M12-320</b>	<b>C E H</b>	
	 M12	0 ... 10 V	4 ... 20 mA	Quasi-embed.	–25 ... +70°C	IP67	<b>DW-AS-509-M12-390</b>	<b>C E H</b>	
		0 ... 5 V	1 ... 5 mA	Quasi-embed.	–25 ... +70°C	IP67	<b>DW-AD-509-M18</b>	<b>E H</b>	
		0 ... 5 V	1 ... 5 mA	Quasi-embed.	–25 ... +70°C	IP67	<b>DW-AD-509-M18-120</b>	<b>E H</b>	
		0 ... 10 V	4 ... 20 mA	Quasi-embed.	–25 ... +70°C	IP67	<b>DW-AD-509-M18-320</b>	<b>E H</b>	
		0 ... 10 V	4 ... 20 mA	Quasi-embed.	–25 ... +70°C	IP67	<b>DW-AD-509-M18-390</b>	<b>E H</b>	
		0 ... 5 V	1 ... 5 mA	Non-embed.	–25 ... +70°C	IP67	<b>DW-AD-519-M18</b>	<b>E H</b>	
		0 ... 5 V	1 ... 5 mA	Non-embed.	–25 ... +70°C	IP67	<b>DW-AD-519-M18-120</b>	<b>E H</b>	
		0 ... 10 V	4 ... 20 mA	Non-embed.	–25 ... +70°C	IP67	<b>DW-AD-519-M18-320</b>	<b>E H</b>	
		0 ... 10 V	4 ... 20 mA	Non-embed.	–25 ... +70°C	IP67	<b>DW-AD-519-M18-390</b>	<b>E H</b>	
	 M12	0 ... 5 V	1 ... 5 mA	Quasi-embed.	–25 ... +70°C	IP67	<b>DW-AS-509-M18-002</b>	<b>C E H</b>	
	 M12	0 ... 5 V	1 ... 5 mA	Quasi-embed.	–25 ... +70°C	IP67	<b>DW-AS-509-M18-120</b>	<b>C E H</b>	
	 M12	0 ... 10 V	4 ... 20 mA	Quasi-embed.	–25 ... +70°C	IP67	<b>DW-AS-509-M18-320</b>	<b>C E H</b>	
	 M12	0 ... 10 V	4 ... 20 mA	Quasi-embed.	–25 ... +70°C	IP67	<b>DW-AS-509-M18-390</b>	<b>C E H</b>	
	 M12	0 ... 5 V	1 ... 5 mA	Non-embed.	–25 ... +70°C	IP67	<b>DW-AS-519-M18-002</b>	<b>C E H</b>	
	 M12	0 ... 5 V	1 ... 5 mA	Non-embed.	–25 ... +70°C	IP67	<b>DW-AS-519-M18-120</b>	<b>C E H</b>	
	 M12	0 ... 10 V	4 ... 20 mA	Non-embed.	–25 ... +70°C	IP67	<b>DW-AS-519-M18-320</b>	<b>C E H</b>	
	 M12	0 ... 10 V	4 ... 20 mA	Non-embed.	–25 ... +70°C	IP67	<b>DW-AS-519-M18-390</b>	<b>C E H</b>	

# INDUCTIVE SENSORS ANALOG OUTPUT



## COMMON FEATURE

Supply Voltage range	15 ... 30 VDC
----------------------	---------------

## OUTPUT

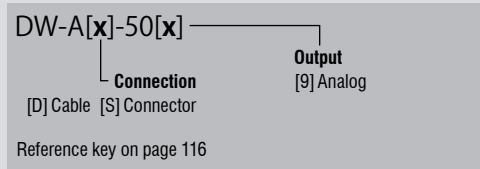

## ACCESSORIES

- A** Group A: M8 3-pin  
Sub-group: Field attachable connectors  
Sub-group: Distribution boxes
- B** Group B: M8 4-pin
- C** Group C: M12 4-pin  
Sub-group: Field attachable connectors  
Sub-group: Distribution boxes
- D** Group D: M12 AC/DC 3-pin
- E** Group E: Universal mounting brackets  
Sub-group: Mechanical stops
- F** Group F: Photoelectric mounting brackets
- G** Group G: Photoelectric reflectors
- H** Group H: Sensor tester

Go to page 298 for details

**CABLES**  
Cable lengths available:  
2 m, 5 m, 10 m  
other customised lengths possible

FAMILY	OPERATING DISTANCE (mm)	HOUSING SIZE (mm)	HOUSING LENGTH (mm)	HOUSING MATERIAL
	20	M30	60	Chrome-plated brass
	20	M30	35	Chrome-plated brass
	20	M30	35	Chrome-plated brass
	20	M30	60	Chrome-plated brass
	40	M30	50	Chrome-plated brass
	40	M30	25	Chrome-plated brass
	40	M30	25	Chrome-plated brass
	40	M30	50	Chrome-plated brass
	20	M30	73.5	Chrome-plated brass
	20	M30	48.5	Chrome-plated brass
	20	M30	48.5	Chrome-plated brass
	20	M30	73.5	Chrome-plated brass
	40	M30	73.5	Chrome-plated brass
	40	M30	48.5	Chrome-plated brass
	40	M30	48.5	Chrome-plated brass
	40	M30	73.5	Chrome-plated brass

EXTRA DISTANCE – SERIES 500





	CABLE	CONNECTOR	OUTPUT 1	OUTPUT 2	MOUNTING		AMBIENT TEMPERATURE	DEGREE OF PROTECTION	PART REFERENCE	ACCESSORIES (SEE PAGE 64)
					EMB.	NON-EMB.				
			0 ... 5 V	1 ... 5 mA	Quasi-embed.		-25 ... +70°C	IP67	DW-AD-509-M30	E H
			0 ... 5 V	1 ... 5 mA	Quasi-embed.		-25 ... +70°C	IP67	DW-AD-509-M30-120	E H
			0 ... 10 V	4 ... 10 mA	Quasi-embed.		-25 ... +70°C	IP67	DW-AD-509-M30-320	E H
			0 ... 10 V	4 ... 20 mA	Quasi-embed.		-25 ... +70°C	IP67	DW-AD-509-M30-390	E H
			0 ... 5 V	1 ... 5 mA	Non-embed.		-25 ... +70°C	IP67	DW-AD-519-M30	E H
			0 ... 5 V	1 ... 5 mA	Non-embed.		-25 ... +70°C	IP67	DW-AD-519-M30-120	E H
			0 ... 10 V	4 ... 10 mA	Non-embed.		-25 ... +70°C	IP67	DW-AD-519-M30-320	E H
			0 ... 10 V	4 ... 20 mA	Non-embed.		-25 ... +70°C	IP67	DW-AD-519-M30-390	E H
		M12	0 ... 5 V	1 ... 5 mA	Quasi-embed.		-25 ... +70°C	IP67	DW-AS-509-M30-002	C E H
		M12	0 ... 5 V	1 ... 5 mA	Quasi-embed.		-25 ... +70°C	IP67	DW-AS-509-M30-120	C E H
		M12	0 ... 10 V	4 ... 10 mA	Quasi-embed.		-25 ... +70°C	IP67	DW-AS-509-M30-320	C E H
		M12	0 ... 10 V	4 ... 20 mA	Quasi-embed.		-25 ... +70°C	IP67	DW-AS-509-M30-390	C E H
		M12	0 ... 5 V	1 ... 5 mA	Non-embed.		-25 ... +70°C	IP67	DW-AS-519-M30-002	C E H
		M12	0 ... 5 V	1 ... 5 mA	Non-embed.		-25 ... +70°C	IP67	DW-AS-519-M30-120	C E H
		M12	0 ... 10 V	4 ... 10 mA	Non-embed.		-25 ... +70°C	IP67	DW-AS-519-M30-320	C E H
		M12	0 ... 10 V	4 ... 20 mA	Non-embed.		-25 ... +70°C	IP67	DW-AS-519-M30-390	C E H

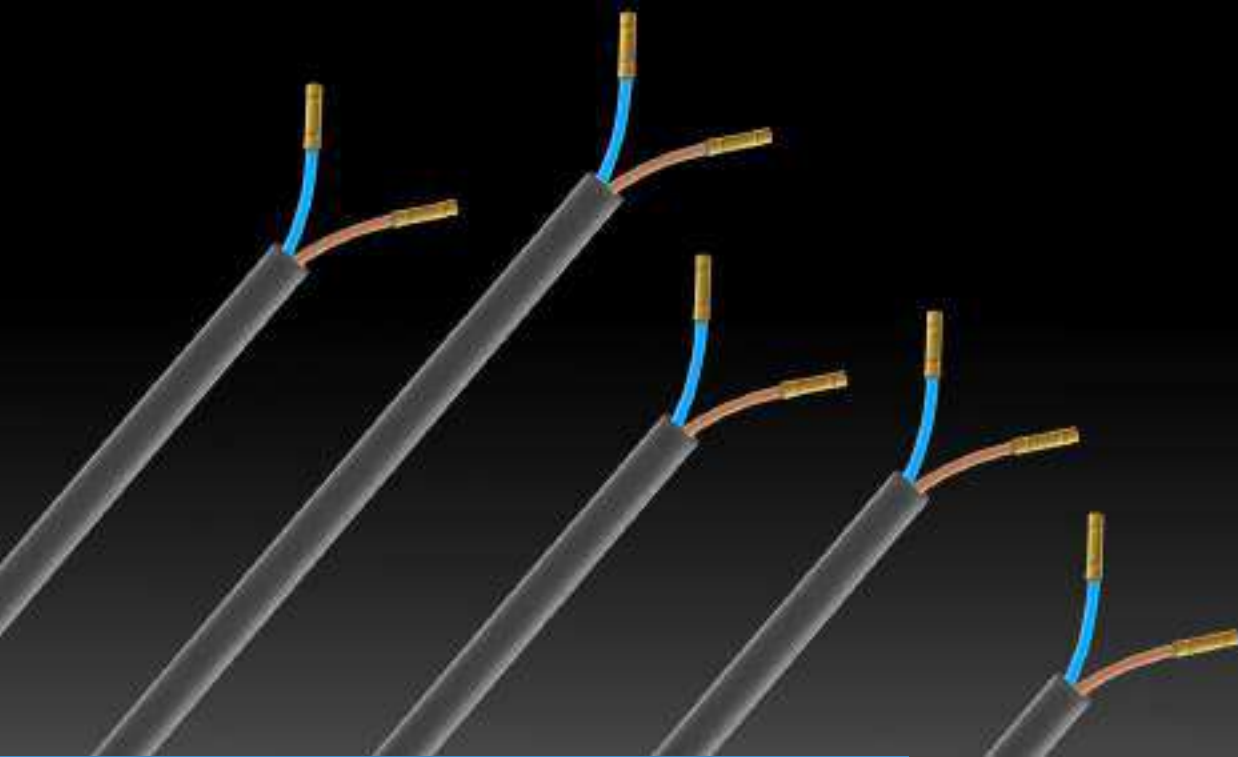

## APPLICATION

### Inductive sensors confirm retraction of stabilizer legs in mobile cranes

A manufacturer of mobile cranes uses two-wire inductive sensors with N.C. output function to detect the position of stabilizer legs as part of the vehicle safety system. Before the system will allow the driver to drive the vehicle away, sensors confirm that stabilizer legs have been retracted.

## INDUSTRIES

Automotive production and supply, machine tool, packaging, logistics, materials handling, textile



*Automotive part sensing*



*Spindle-cutting machine tool*



*Textile spinning machine automation*



*Logistics*

# 2-WIRE

## INDUCTIVE SENSORS

### EASY INSTALLATION AND HIGH SWITCHING FREQUENCY

The **2-Wire** range of DC, AC/DC and NAMUR sensors is constructed on the **Classics** technology platform and includes sizes from Ø3 to M30, plus a 5 × 5 mm square-section type. Devices are available for embeddable or non-embeddable mounting and connection is by means of cable or connector. With a sensing range up to **15 mm**, Contrinex **2-Wire** sensors ensure optimal equipment utilization.

#### KEY ADVANTAGES

- ✓ Two-wire sensors for series connection
- ✓ Sizes from Ø3 mm to M30 and 5 × 5 mm
- ✓ DC and AC/DC types
- ✓ NAMUR types with switching frequencies up to 10,000 Hz



#### PRODUCT OVERVIEW

Housing size mm	Ø3	M4	Ø4	M5	C5	Ø6.5	M8	M12	M18	M30
Classics (s <sub>n</sub> mm)	0.6	0.6	0.8	0.8	0.8	1.5	1.5/2.5	2/4	5/8	10/15

#### ACCESSORIES

Go to page 298 to see all the accessories

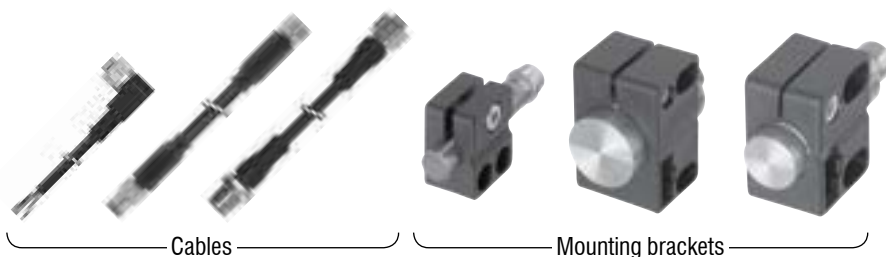

# INDUCTIVE SENSORS 2-WIRE



## COMMON FEATURES

<b>Output</b>	NO or NAMUR
---------------	-------------

\* Other type available: NC

## OUTPUT

Go to page 116 for details

## ACCESSORIES

	<b>A</b> Group A: M8 3-pin Sub-group: Field attachable connectors Sub-group: Distribution boxes
	<b>B</b> Group B: M8 4-pin
	<b>C</b> Group C: M12 4-pin Sub-group: Field attachable connectors Sub-group: Distribution boxes
	<b>D</b> Group D: M12 AC/DC 3-pin
	<b>E</b> Group E: Universal mounting brackets Sub-group: Mechanical stops
	<b>F</b> Group F: Photoelectric mounting brackets
	<b>G</b> Group G: Photoelectric reflectors
	<b>H</b> Group H: Sensor tester

Go to page 298 for details

	<b>CABLES</b> Cable lengths available: 2 m, 5 m, 10 m other customised lengths possible
--	--

FAMILY	OPERATING DISTANCE (mm)	HOUSING SIZE (mm)	HOUSING LENGTH (mm)	HOUSING MATERIAL
CLASSICS – SERIES 600	0.6	Ø 3	22	Stainless steel V2A
	0.6	Ø 3	22	Stainless steel V2A
	0.6	M4	22	Stainless steel V2A
	0.6	M4	22	Stainless steel V2A
	0.8	Ø 4	25	Stainless steel V2A
	0.8	Ø 4	38	Stainless steel V2A
	0.8	M5	25	Stainless steel V2A
	0.8	M5	38	Stainless steel V2A
	0.8	5 × 5 (C5)	25	Nickel-chrome-plated brass
	0.8	5 × 5 (C5)	25	Nickel-chrome-plated brass
	1.5	Ø 6.5	16	Stainless steel V2A
	1.5	Ø 6.5	35	Stainless steel V2A
	2	Ø 6.5	35	Stainless steel V2A
	1.5	M8	16	Stainless steel V2A
	1.5	M8	35	Stainless steel V2A
	2.5	M8	35	Stainless steel V2A
	1.5	M8	45	Stainless steel V2A
	1.5	M8	45	Stainless steel V2A
	2.5	M8	45	Stainless steel V2A
	2.5	M8	45	Stainless steel V2A
	2.5	M8	45	Stainless steel V2A
	2	M8	35	Stainless steel V2A
	2	M8	45	Stainless steel V2A
	2	M12	50	Chrome-plated brass
	2	M12	60	Chrome-plated brass
	4	M12	50	Chrome-plated brass
	4	M12	60	Chrome-plated brass
	4	M12	50	Chrome-plated brass
	4	M12	60	Chrome-plated brass
	4	M12	35	Chrome-plated brass
4	M12	45	Chrome-plated brass	



CABLE	CONNECTOR	SUPPLY VOLTAGE	SWITCHING FREQUENCY (Hz)	MOUNTING		AMBIENT TEMPERATURE	DEGREE OF PROTECTION	PART REFERENCE*	ACCESSORIES (SEE PAGE 68)
				EMB. 	NON-EMB. 				
		7.7 ... 9 VDC	10,000	Embed.		-25 ... +70°C	IP67	DW-AD-605-03	E
		7.7 ... 9 VDC	10,000	Embed.		-25 ... +70°C	IP67	DW-AS-605-03	A E
		7.7 ... 9 VDC	10,000	Embed.		-25 ... +70°C	IP67	DW-AD-605-M4	E
		7.7 ... 9 VDC	10,000	Embed.		-25 ... +70°C	IP67	DW-AS-605-M4	A E
		7.7 ... 9 VDC	10,000	Embed.		-25 ... +70°C	IP67	DW-AD-605-04	E
		7.7 ... 9 VDC	10,000	Embed.		-25 ... +70°C	IP67	DW-AS-605-04	A E
		7.7 ... 9 VDC	10,000	Embed.		-25 ... +70°C	IP67	DW-AD-605-M5	E
		7.7 ... 9 VDC	10,000	Embed.		-25 ... +70°C	IP67	DW-AS-605-M5	A E
		7.7 ... 9 VDC	10,000	Embed.		-25 ... +70°C	IP67	DW-AD-605-C5	
		7.7 ... 9 VDC	10,000	Embed.		-25 ... +70°C	IP67	DW-AS-605-C5	A
		7.7 ... 9 VDC	10,000	Embed.		-25 ... +70°C	IP67	DW-AD-605-065-120	E
		10 ... 65 VDC	5,000	Embed.		-25 ... +70°C	IP67	DW-DD-605-065	E H
		10 ... 65 VDC	5,000	Embed.		-25 ... +70°C	IP67	DW-DD-625-065	E H
		7.7 ... 9 VDC	10,000	Embed.		-25 ... +70°C	IP67	DW-AD-605-M8-120	E
		10 ... 65 VDC	5,000	Embed.		-25 ... +70°C	IP67	DW-DD-605-M8	E H
		10 ... 65 VDC	5,000	Non-embed.		-25 ... +70°C	IP67	DW-DD-615-M8	E H
		10 ... 65 VDC	5,000	Embed.		-25 ... +70°C	IP67	DW-DS-605-M8	C E H
		10 ... 65 VDC	5,000	Embed.		-25 ... +70°C	IP67	DW-DS-605-M8-001	A E H
		10 ... 65 VDC	5,000	Non-embed.		-25 ... +70°C	IP67	DW-DS-615-M8	C E H
		10 ... 65 VDC	5,000	Non-embed.		-25 ... +70°C	IP67	DW-DS-615-M8-001	A E H
		10 ... 65 VDC	5,000	Embed.		-25 ... +70°C	IP67	DW-DD-625-M8	E H
		10 ... 65 VDC	5,000	Embed.		-25 ... +70°C	IP67	DW-DS-625-M8-001	A E H
		10 ... 65 VDC	3,000	Embed.		-25 ... +70°C	IP67	DW-DD-605-M12	E H
		10 ... 65 VDC	3,000	Embed.		-25 ... +70°C	IP67	DW-DS-605-M12	C E H
		10 ... 65 VDC	2,500	Non-embed.		-25 ... +70°C	IP67	DW-DD-615-M12	E H
		10 ... 65 VDC	2,500	Non-embed.		-25 ... +70°C	IP67	DW-DS-615-M12	C E H
		10 ... 65 VDC	2,000	Embed.		-25 ... +70°C	IP67	DW-DD-625-M12	E H
		10 ... 65 VDC	2,000	Embed.		-25 ... +70°C	IP67	DW-DS-625-M12	C E H
		10 ... 65 VDC	2,000	Embed.		-25 ... +70°C	IP67	DW-DD-625-M12-120	E H
		10 ... 65 VDC	2,000	Embed.		-25 ... +70°C	IP67	DW-DS-625-M12-120	C E H

# INDUCTIVE SENSORS 2-WIRE



## COMMON FEATURES









<b>Output</b>	NO or NAMUR
---------------	-------------

\* Other type available: NC

## OUTPUT

Go to page 116 for details

## ACCESSORIES

-  **A** Group A: M8 3-pin  
Sub-group: Field attachable connectors  
Sub-group: Distribution boxes
-  **B** Group B: M8 4-pin
-  **C** Group C: M12 4-pin  
Sub-group: Field attachable connectors  
Sub-group: Distribution boxes
-  **D** Group D: M12 AC/DC 3-pin
-  **E** Group E: Universal mounting brackets  
Sub-group: Mechanical stops
-  **F** Group F: Photoelectric mounting brackets
-  **G** Group G: Photoelectric reflectors
-  **H** Group H: Sensor tester

Go to page 298 for details



**CABLES**  
Cable lengths available:  
2 m, 5 m, 10 m  
other customised lengths possible

FAMILY	OPERATING DISTANCE (mm)	HOUSING SIZE (mm)	HOUSING LENGTH (mm)	HOUSING MATERIAL
CLASSICS – SERIES 600	2	M12	35	Chrome-plated brass
	2	M12	45	Chrome-plated brass
	4	M12	35	Chrome-plated brass
	4	M12	45	Chrome-plated brass
	2	M12	50	Chrome-plated brass
	2	M12	35	Chrome-plated brass
	4	M12	50	Chrome-plated brass
	4	M12	35	Chrome-plated brass
	2	M12	50	Chrome-plated brass
	4	M12	50	Chrome-plated brass
	4	M12	50	Chrome-plated brass
	2	M12	60	Chrome-plated brass
	4	M12	60	Chrome-plated brass
	4	M12	60	Chrome-plated brass
	5	M18	50	Chrome-plated brass
	5	M18	63.5	Chrome-plated brass
	8	M18	50	Chrome-plated brass
	8	M18	63.5	Chrome-plated brass
	8	M18	50	Chrome-plated brass
	8	M18	63.5	Chrome-plated brass
	5	M18	35	Chrome-plated brass
	5	M18	48.5	Chrome-plated brass
	8	M18	35	Chrome-plated brass
	8	M18	48.5	Chrome-plated brass
	8	M18	35	Chrome-plated brass
	8	M18	48.5	Chrome-plated brass
	5	M18	50	Chrome-plated brass
	5	M18	35	Chrome-plated brass
5	M18	50	Chrome-plated brass	
8	M18	50	Chrome-plated brass	



CABLE	CONNECTOR	SUPPLY VOLTAGE	SWITCHING FREQUENCY (Hz)	MOUNTING		AMBIENT TEMPERATURE	DEGREE OF PROTECTION	PART REFERENCE*	ACCESSORIES (SEE PAGE 70)
				EMB. 	NON-EMB. 				
		10 ... 65 VDC	3,000	Embed.		-25 ... +70°C	IP67	DW-DD-605-M12-120	E H
		10 ... 65 VDC	3,000	Embed.		-25 ... +70°C	IP67	DW-DS-605-M12-120	C E H
		10 ... 65 VDC	2,500	Non-embed.		-25 ... +70°C	IP67	DW-DD-615-M12-120	E H
		10 ... 65 VDC	2,500	Non-embed.		-25 ... +70°C	IP67	DW-DS-615-M12-120	C E H
		7.7 ... 9 VDC	2,500	Embed.		-25 ... +70°C	IP67	DW-AD-605-M12	E
		7.7 ... 9 VDC	2,500	Embed.		-25 ... +70°C	IP67	DW-AD-605-M12-120	E
		7.7 ... 9 VDC	1,000	Non-embed.		-25 ... +70°C	IP67	DW-AD-615-M12	E
		7.7 ... 9 VDC	1,000	Non-embed.		-25 ... +70°C	IP67	DW-AD-615-M12-120	E
		20 ... 265/10 ... 320 VAC/VDC	25 Hz AC / 3,000 Hz DC	Embed.		-25 ... +70°C	IP67	DW-AD-607-M12	E H
		20 ... 265/10 ... 320 VAC/VDC	25 Hz AC / 2,000 Hz DC	Non-embed.		-25 ... +70°C	IP67	DW-AD-617-M12	E H
		20 ... 265/10 ... 320 VAC/VDC	25 Hz AC / 2,000 Hz DC	Embed.		-25 ... +70°C	IP67	DW-AD-627-M12	E H
		20 ... 265/10 ... 320 VAC/VDC	25 Hz AC / 3,000 Hz DC	Embed.		-25 ... +70°C	IP67	DW-AS-607-M12-069	D E H
		20 ... 265/10 ... 320 VAC/VDC	25 Hz AC / 2,000 Hz DC	Non-embed.		-25 ... +70°C	IP67	DW-AS-617-M12-069	D E H
		20 ... 265/10 ... 320 VAC/VDC	25 Hz AC / 2,000 Hz DC	Embed.		-25 ... +70°C	IP67	DW-AS-627-M12-069	D E H
		10 ... 65 VDC	1,500	Embed.		-25 ... +70°C	IP67	DW-DD-605-M18	E H
		10 ... 65 VDC	1,500	Embed.		-25 ... +70°C	IP67	DW-DS-605-M18-002	C E H
		10 ... 65 VDC	1,200	Non-embed.		-25 ... +70°C	IP67	DW-DD-615-M18	E H
		10 ... 65 VDC	1,200	Non-embed.		-25 ... +70°C	IP67	DW-DS-615-M18-002	C E H
		10 ... 65 VDC	1,000	Quasi-embed.		-25 ... +70°C	IP67	DW-DD-625-M18	E H
		10 ... 65 VDC	1,000	Quasi-embed.		-25 ... +70°C	IP67	DW-DS-625-M18-002	C E H
		10 ... 65 VDC	1,500	Embed.		-25 ... +70°C	IP67	DW-DD-605-M18-120	E H
		10 ... 65 VDC	1,500	Embed.		-25 ... +70°C	IP67	DW-DS-605-M18-120	C E H
		10 ... 65 VDC	1,200	Non-embed.		-25 ... +70°C	IP67	DW-DD-615-M18-120	E H
		10 ... 65 VDC	1,200	Non-embed.		-25 ... +70°C	IP67	DW-DS-615-M18-120	C E H
		10 ... 65 VDC	1,000	Quasi-embed.		-25 ... +70°C	IP67	DW-DD-625-M18-120	E H
		10 ... 65 VDC	1,000	Quasi-embed.		-25 ... +70°C	IP67	DW-DS-625-M18-120	C E H
		7.7 ... 9 VDC	1,000	Embed.		-25 ... +70°C	IP67	DW-AD-605-M18	E
		7.7 ... 9 VDC	1,000	Embed.		-25 ... +70°C	IP67	DW-AD-605-M18-120	E
		20 ... 265/10 ... 320 VAC/VDC	25 Hz AC / 1,500 Hz DC	Embed.		-25 ... +70°C	IP67	DW-AD-607-M18	E H
		20 ... 265/10 ... 320 VAC/VDC	25 Hz AC / 1,200 Hz DC	Non-embed.		-25 ... +70°C	IP67	DW-AD-617-M18	E H

# INDUCTIVE SENSORS 2-WIRE



## COMMON FEATURES









<b>Output</b>	NO or NAMUR
---------------	-------------

\* Other type available: NC

## OUTPUT

Go to page 116 for details

## ACCESSORIES

-  **A** Group A: M8 3-pin  
Sub-group: Field attachable connectors  
Sub-group: Distribution boxes
-  **B** Group B: M8 4-pin
-  **C** Group C: M12 4-pin  
Sub-group: Field attachable connectors  
Sub-group: Distribution boxes
-  **D** Group D: M12 AC/DC 3-pin
-  **E** Group E: Universal mounting brackets  
Sub-group: Mechanical stops
-  **F** Group F: Photoelectric mounting brackets
-  **G** Group G: Photoelectric reflectors
-  **H** Group H: Sensor tester

Go to page 298 for details



**CABLES**  
Cable lengths available:  
2 m, 5 m, 10 m  
other customised lengths possible

# CLASSICS – SERIES 600

FAMILY	OPERATING DISTANCE (mm)	HOUSING SIZE (mm)	HOUSING LENGTH (mm)	HOUSING MATERIAL
	5	M18	63.5	Chrome-plated brass
	8	M18	63.5	Chrome-plated brass
	10	M30	50	Chrome-plated brass
	10	M30	63.5	Chrome-plated brass
	15	M30	50	Chrome-plated brass
	15	M30	63.5	Chrome-plated brass
	10	M30	35	Chrome-plated brass
	10	M30	48.5	Chrome-plated brass
	15	M30	35	Chrome-plated brass
	15	M30	48.5	Chrome-plated brass
	10	M30	50	Chrome-plated brass
	10	M30	35	Chrome-plated brass
	10	M30	50	Chrome-plated brass
	15	M30	50	Chrome-plated brass
	10	M30	63.5	Chrome-plated brass
	15	M30	63.5	Chrome-plated brass





CABLE	CONNECTOR	SUPPLY VOLTAGE	SWITCHING FREQUENCY (Hz)	MOUNTING		AMBIENT TEMPERATURE	DEGREE OF PROTECTION	PART REFERENCE*	ACCESSORIES (SEE PAGE 72)
				EMB. 	NON-EMB. 				
	UNF 1/2"	20...265/10...320 VAC/VDC	25 Hz AC / 1,500 Hz DC	Embed.		-25 ... +70°C	IP67	DW-AS-607-M18-069	D E H
	UNF 1/2"	20...265/10...320 VAC/VDC	25 Hz AC / 1,200 Hz DC	Non-embed.		-25 ... +70°C	IP67	DW-AS-617-M18-069	D E H
		10 ... 65 VDC	600	Embed.		-25 ... +70°C	IP67	DW-DD-605-M30	E H
	M12	10 ... 65 VDC	600	Embed.		-25 ... +70°C	IP67	DW-DS-605-M30-002	C E H
		10 ... 65 VDC	500	Non-embed.		-25 ... +70°C	IP67	DW-DD-615-M30	E H
	M12	10 ... 65 VDC	500	Non-embed.		-25 ... +70°C	IP67	DW-DS-615-M30-002	C E H
		10 ... 65 VDC	600	Embed.		-25 ... +70°C	IP67	DW-DD-605-M30-120	E H
	M12	10 ... 65 VDC	600	Embed.		-25 ... +70°C	IP67	DW-DS-605-M30-120	C E H
		10 ... 65 VDC	500	Non-embed.		-25 ... +70°C	IP67	DW-DD-615-M30-120	E H
	M12	10 ... 65 VDC	500	Non-embed.		-25 ... +70°C	IP67	DW-DS-615-M30-120	C E H
		7.7 ... 9 VDC	400	Embed.		-25 ... +70°C	IP67	DW-AD-605-M30	E
		7.7 ... 9 VDC	400	Embed.		-25 ... +70°C	IP67	DW-AD-605-M30-120	E
		20...265/10...320 VAC/VDC	25 Hz AC / 600 Hz DC	Embed.		-25 ... +70°C	IP67	DW-AD-607-M30	E H
		20...265/10...320 VAC/VDC	25 Hz AC / 500 Hz DC	Non-embed.		-25 ... +70°C	IP67	DW-AD-617-M30	E H
	UNF 1/2"	20...265/10...320 VAC/VDC	25 Hz AC / 600 Hz DC	Embed.		-25 ... +70°C	IP67	DW-AS-607-M30-069	D E H
	UNF 1/2"	20...265/10...320 VAC/VDC	25 Hz AC / 500 Hz DC	Non-embed.		-25 ... +70°C	IP67	DW-AS-617-M30-069	D E H



## APPLICATION

### Inductive sensors check presence of correct drilling tool in CNC machine

During operation of an automated CNC machining center, pressurized machining fluid lubricates and cools the drill assembly before the tool-changing robot selects the next tool. Standard inductive sensors would be unreliable in this harsh environment. Instead, Extra Pressure sensors are used to check the presence of the correct drilling tool on the robot arm. With increased pressure resistance, a gas-tight sensing face, a protection rating of IP68 and PUR cable, these sensors provide high accuracy and long life, even when exposed to pressurized fluids.

## INDUSTRIES

Automotive production and supply, machine tool, energy, pneumatics, lubrication systems, pumps, valves



*Micromechanical grippers*



*Pump and valve control*



*Automotive part sensing*



*Machine tools*

# EXTRA PRESSURE INDUCTIVE SENSORS

PRESSURE RESISTANT  
UP TO 200 BAR (2,901 PSI)

Dependable, accurate presence- and position-sensing at pressures up to **200 bar** requires world-class performance and build quality. Contrinex **Extra Pressure** inductive sensors deliver exactly that, operating continuously in pressurized conditions. The combination of a stainless-steel housing and an impermeably bonded ceramic or sapphire-glass sensing face guarantees robustness and reliability.

## KEY ADVANTAGES

- ✓ Pressure resistant up to 200 bar (2,901 psi)
- ✓ High quality ASIC sensors with  IO-Link interface
- ✓ Mechanically and chemically rugged
- ✓ Impervious: IP68
- ✓ Gas-tight sensing face
- ✓ Miniature devices



## PRODUCT OVERVIEW

		 IO-Link			
Housing size mm		Ø3	Ø4	Ø6.5	M8
s <sub>n</sub> mm	Extra Distance	–	–	2.5	2.5
	Classics	0.8	0.6	–	–

## ACCESSORIES

Go to page 298 to see all the accessories

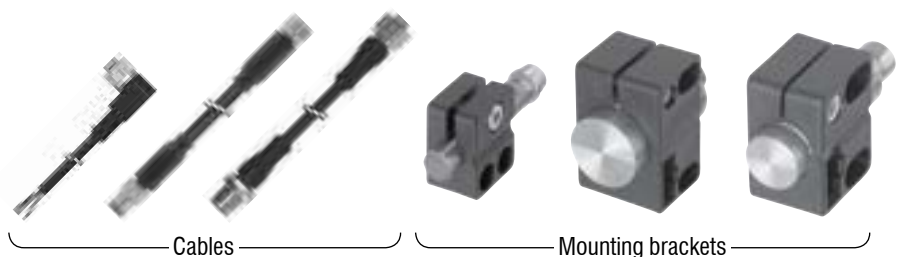

# INDUCTIVE SENSORS EXTRA PRESSURE



## COMMON FEATURES

Supply Voltage range	10 ... 30 VDC
Housing material	Stainless steel V2A

## OUTPUT

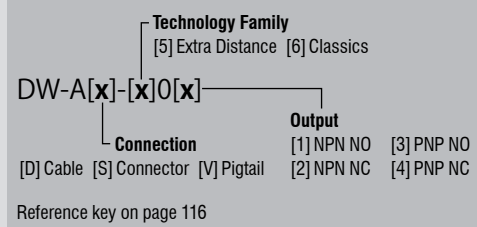

## ACCESSORIES

- A** Group A: M8 3-pin  
Sub-group: Field attachable connectors  
Sub-group: Distribution boxes
- B** Group B: M8 4-pin
- C** Group C: M12 4-pin  
Sub-group: Field attachable connectors  
Sub-group: Distribution boxes
- D** Group D: M12 AC/DC 3-pin
- E** Group E: Universal mounting brackets  
Sub-group: Mechanical stops
- F** Group F: Photoelectric mounting brackets
- G** Group G: Photoelectric reflectors
- H** Group H: Sensor tester

Go to page 298 for details

**CABLES**  
Cable lengths available:  
2 m, 5 m, 10 m  
other customised lengths possible

FAMILY	OPERATING DISTANCE (mm)	HOUSING SIZE (mm)	HOUSING LENGTH (mm)	OPERATING PRESSURE
EXTRA DISTANCE – SERIES 500	2.5	Ø 6.5	45	≤ 20 bar
	2.5	Ø 6.5	45	≤ 20 bar
	2.5	Ø 6.5	45	≤ 20 bar
	2.5	Ø 6.5	45	≤ 20 bar
	2.5	M8	45	≤ 20 bar
	2.5	M8	45	≤ 20 bar
	2.5	M8	45	≤ 20 bar
	2.5	M8	45	≤ 20 bar

CLASSICS SERIES 600	0.8	Ø 3	12	≤ 200 bar
	0.8	Ø 3	12	≤ 200 bar
	0.6	Ø 4	25	≤ 20 bar
	0.6	Ø 4	25	≤ 20 bar
	0.6	Ø 4	25	≤ 20 bar
	0.6	Ø 4	25	≤ 20 bar





CABLE	CONNECTOR	IO-Link	SWITCHING FREQUENCY (Hz)	MOUNTING		AMBIENT TEMPERATURE	DEGREE OF PROTECTION	PART REFERENCE	ACCESSORIES (SEE PAGE 76)
				EMB.	NON-EMB.				
PUR			1,000	Embed.		-25 ... +70°C	IP68	DW-AD-501-065E	E H
PUR			1,000	Embed.		-25 ... +70°C	IP68	DW-AD-502-065E	E H
PUR		IO-Link	1,000	Embed.		-25 ... +70°C	IP68	DW-AD-503-065E	E H
PUR			1,000	Embed.		-25 ... +70°C	IP68	DW-AD-504-065E	E H
PUR			1,000	Embed.		-25 ... +70°C	IP68	DW-AD-501-M8E	E H
PUR			1,000	Embed.		-25 ... +70°C	IP68	DW-AD-502-M8E	E H
PUR		IO-Link	1,000	Embed.		-25 ... +70°C	IP68	DW-AD-503-M8E	E H
PUR			1,000	Embed.		-25 ... +70°C	IP68	DW-AD-504-M8E	E H
PUR			8,000	Embed.		-25 ... +70°C	IP68 / IP69K	DW-AD-621-03E-961	E H
PUR		IO-Link	8,000	Embed.		-25 ... +70°C	IP68 / IP69K	DW-AD-623-03E-961	E H
PUR			5,000	Embed.		-25 ... +70°C	IP68	DW-AD-601-04E	E H
PUR		IO-Link	5,000	Embed.		-25 ... +70°C	IP68	DW-AD-603-04E	E H
PUR			5,000	Embed.		-25 ... +70°C	IP68	DW-AD-604-04E	E H





## APPLICATION

### Ram position sensing for manual punch-rieveting tool

A manufacturer of cold-forming tools for joining sheet metal uses position sensing to control the operation of a manual punch-rieveting tool. A high-pressure inductive sensor mounted directly into the wall of a small pneumo-hydraulic cylinder detects the position of the hydraulic ram, preventing the operating cycle from starting unless the ram is fully retracted.

## INDUSTRIES

Automotive production and supply, machine tool, energy, maritime, hydraulic and fluid power, concrete pumps, injection molding machines



*Hydraulic cylinder control with sensors*



*Valve control for concrete pumps*



*Automotive industry*



*Maritime industry*

# HIGH PRESSURE INDUCTIVE SENSORS

## PRESSURE RESISTANT UP TO 500 BAR (7,255 PSI)

Contrinex **High Pressure** inductive sensors are suitable for continuous duty at pressures up to **500 bar** (1,000 bar peak pressure), ensuring reliable sensing in the most demanding pneumatic and hydraulic applications. Available with classic metal housing or one-piece, stainless-steel construction, these sensors detect the smallest parts and are ideal for piston-control applications.

### KEY ADVANTAGES

- ✓ Highest operating (500 bar/7,255 psi) and peak pressure (1,000 bar/14,510 psi) on the market
- ✓ Resistant to pressure cycles: 50 times longer lifetime under pressure than the market standard
- ✓ Gas-tight sensing face
- ✓ Large temperature range  $-25^{\circ}\text{C}$  ( $-13^{\circ}\text{F}$ ) ...  $+100^{\circ}\text{C}$  ( $+212^{\circ}\text{F}$ )
- ✓ High quality ASIC sensors with  **IO-Link** interface



## PRODUCT OVERVIEW

		 <b>IO-Link</b>			
Housing size mm		M5 / P5	M8 / P8	M12 / P12	M14 / P20
s <sub>n</sub> mm	Extra Distance	1	1.5	1.5 ... 2.5	3
	Full Inox	–	–	1.5	–

## ACCESSORIES

Go to page 298 to see all the accessories

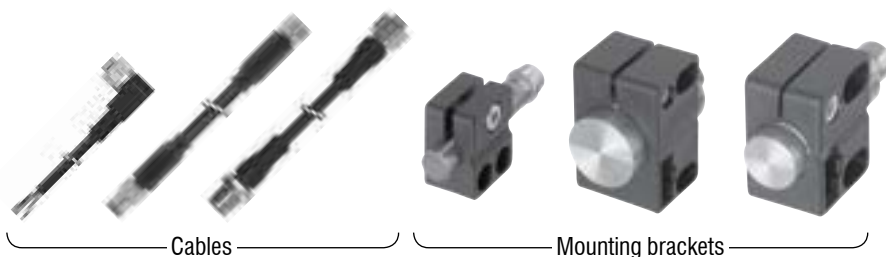

# INDUCTIVE SENSORS HIGH PRESSURE



## COMMON FEATURES

<b>Supply Voltage range</b>	10 ... 30 VDC
<b>Output</b>	PNP NO*

\* Other types available: PNP NC, NPN NC

\*\* Pigtail versions available

## OUTPUT

DW-A[x]-50[x]	
<b>Connection</b>	<b>Output</b>
[D] Cable [S] Connector [V] Pigtail	[1] NPN NO [3] PNP NO [2] NPN NC [4] PNP NC

Reference key on page 116

## ACCESSORIES

- A** Group A: M8 3-pin  
Sub-group: Field attachable connectors  
Sub-group: Distribution boxes
- B** Group B: M8 4-pin
- C** Group C: M12 4-pin  
Sub-group: Field attachable connectors  
Sub-group: Distribution boxes
- D** Group D: M12 AC/DC 3-pin
- E** Group E: Universal mounting brackets  
Sub-group: Mechanical stops
- F** Group F: Photoelectric mounting brackets
- G** Group G: Photoelectric reflectors
- H** Group H: Sensor tester

Go to page 298 for details



## CABLES

Cable lengths available:  
2 m, 5 m, 10 m  
other customised lengths possible

FAMILY	OPERATING DISTANCE (mm)	HOUSING SIZE (mm)	HOUSING LENGTH (mm)	HOUSING MATERIAL
EXTRA DISTANCE – SERIES 500	1	M5	27	Stainless steel DIN 2.4711
	1.5	M8	30	Stainless steel V4A
	1.5	M12	78	Stainless steel V2A
	1.5	M12	47	Stainless steel V2A
	1.5	M12	78	Stainless steel V2A
	1.5	M12	43	Stainless steel V2A
	1.5	M12	69	Stainless steel V2A
	1.5	M12	93	Stainless steel V2A
	1.5	M12	138	Stainless steel V2A
	1.5	M12	56	Stainless steel V2A
	1.5	M12	78	Stainless steel V2A
	1.5	M12	56	Stainless steel V2A
	1.5	M12	93	Stainless steel V2A
	1.5	M12	69	Stainless steel V2A
	1.5	M12	93	Stainless steel V2A
	1.5	M12	138	Stainless steel V2A
	1.5	M12	56	Stainless steel V2A
	1.5	M12	78	Stainless steel V2A
	1.5	M12	56	Stainless steel V2A
	1.5	M12	93	Stainless steel V2A
	2.5	M12	69	Stainless steel V2A
	2.5	M12	93	Stainless steel V2A
	2.5	M12	138	Stainless steel V2A
	2.5	M12	56	Stainless steel V2A
	2.5	M12	78	Stainless steel V2A
	2.5	M12	56	Stainless steel V2A
	2.5	M12	93	Stainless steel V2A
	3	M14	56	Stainless steel V4A
3	M14	65	Stainless steel V4A	



CABLE**	CONNECTOR**	IO-Link	SWITCHING FREQUENCY (Hz)	MOUNTING		AMBIENT TEMPERATURE	DEGREE OF PROTECTION	PART REFERENCE*	ACCESSORIES (SEE PAGE 80)
				EMB.	NON-EMB.				
			1,000	Embed.		-25 ... +100°C	IP68	DW-AD-503-P5	H
			800	Embed.		-25 ... +100°C	IP68	DW-AD-503-P8	H
			600	Embed.		-25 ... +100°C	IP68	DW-AD-503-P12-764	H
			600	Embed.		-25 ... +100°C	IP68	DW-AD-503-P12-625	H
			600	Embed.		-25 ... +100°C	IP68	DW-AD-503-P12-627	H
			600	Embed.		-25 ... +100°C	IP68	DW-AD-503-P12-639	H
			600	Embed.		-25 ... +100°C	IP68	DW-AS-50A-P12	C H
			600	Embed.		-25 ... +100°C	IP68	DW-AS-50A-P12-621	C H
			600	Embed.		-25 ... +100°C	IP68	DW-AS-50A-P12-622	C H
			600	Embed.		-25 ... +100°C	IP68	DW-AS-50A-P12-624	C H
			600	Embed.		-25 ... +100°C	IP68	DW-AS-50A-P12-627	C H
			600	Embed.		-25 ... +100°C	IP68	DW-AS-50A-P12-630	C H
			600	Embed.		-25 ... +100°C	IP68	DW-AS-50A-P12-635	C H
			600	Embed.		-25 ... +100°C	IP68	DW-AS-503-P12	C H
			600	Embed.		-25 ... +100°C	IP68	DW-AS-503-P12-621	C H
			600	Embed.		-25 ... +100°C	IP68	DW-AS-503-P12-622	C H
			600	Embed.		-25 ... +100°C	IP68	DW-AS-503-P12-624	C H
			600	Embed.		-25 ... +100°C	IP68	DW-AS-503-P12-627	C H
			600	Embed.		-25 ... +100°C	IP68	DW-AS-503-P12-630	C H
			600	Embed.		-25 ... +100°C	IP68	DW-AS-503-P12-635	C H
			600	Embed.		-25 ... +100°C	IP68	DW-AS-523-P12	C H
			600	Embed.		-25 ... +100°C	IP68	DW-AS-523-P12-621	C H
			600	Embed.		-25 ... +100°C	IP68	DW-AS-523-P12-622	C H
			600	Embed.		-25 ... +100°C	IP68	DW-AS-523-P12-624	C H
			600	Embed.		-25 ... +100°C	IP68	DW-AS-523-P12-627	C H
			600	Embed.		-25 ... +100°C	IP68	DW-AS-523-P12-630	C H
			600	Embed.		-25 ... +100°C	IP68	DW-AS-523-P12-635	C H
			500	Embed.		-25 ... +100°C	IP68	DW-AD-503-P20	H
			500	Embed.		-25 ... +100°C	IP68	DW-AS-503-P20	C H

# INDUCTIVE SENSORS HIGH PRESSURE



## COMMON FEATURES

<b>Supply Voltage range</b>	10 ... 30 VDC
<b>Output</b>	PNP NO*

\* Other types available: PNP NC, NPN NC

\*\* Pigtail versions available

## OUTPUT

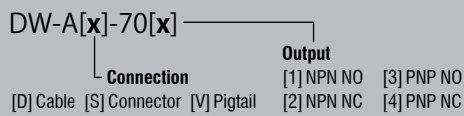

Reference key on page 116

## ACCESSORIES

- A** Group A: M8 3-pin  
Sub-group: Field attachable connectors  
Sub-group: Distribution boxes
- B** Group B: M8 4-pin
- C** Group C: M12 4-pin  
Sub-group: Field attachable connectors  
Sub-group: Distribution boxes
- D** Group D: M12 AC/DC 3-pin
- E** Group E: Universal mounting brackets  
Sub-group: Mechanical stops
- F** Group F: Photoelectric mounting brackets
- G** Group G: Photoelectric reflectors
- H** Group H: Sensor tester

Go to page 298 for details



## CABLES



Cable lengths available:  
2 m, 5 m, 10 m  
other customised lengths possible

FAMILY	OPERATING DISTANCE (mm)	HOUSING SIZE (mm)	HOUSING LENGTH (mm)	HOUSING MATERIAL
	1.5	M12	57.3	Stainless steel V4A
	1.5	M12	61	Stainless steel V4A

FULL INOX – SERIES 700



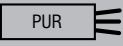

CABLE **	CONNECTOR **	IO-Link	SWITCHING FREQUENCY (Hz)	MOUNTING		AMBIENT TEMPERATURE	DEGREE OF PROTECTION	PART REFERENCE*	ACCESSORIES (SEE PAGE 82)
				EMB.	NON-EMB.				
		IO-Link	850	Embed.		-25 ... +85°C	IP68 / IP69K	DW-LD-703-P12G-003	H
	 M12	IO-Link	850	Embed.		-25 ... +85°C	IP68 / IP69K	DW-LS-703-P12G	C H





## APPLICATION

### Reliable presence sensing despite elevated temperature for automated laundry system

Highly automated laundry systems use inductive sensors for presence sensing in ironing-lane processes. Temperatures in this environment are too high for standard sensors, but pose no problem for temperature-resistant sensors of the Extra Temperature range. They operate reliably at temperatures up to 120°C (248°F), are well protected against ambient humidity (IP67) and include an integral IO-Link interface for communication with modern control and management systems.

## INDUSTRIES

Automotive production and supply, machine tool, energy, aerospace



*Aircraft door monitoring*



*Automotive part sensing*



*Machine tools*



*Aerospace*

# EXTRA TEMPERATURE INDUCTIVE SENSORS

## TEMPERATURE RESISTANT UP TO +120°C (+248°F)

Contrinex **Extra Temperature** inductive sensors offer the ideal solution for position- and presence-sensing applications at temperatures up to 120°C (248°F). Industrial processes often generate more heat than is suitable for standard sensors. In such environments, the stainless-steel construction and robust electronics of this range ensure reliable, accurate operation and minimal downtime.

### KEY ADVANTAGES

- ✓ Temperature resistant up to +120°C (+248°F)
- ✓ Excellent long term reliability
- ✓ Outstanding accuracy
- ✓ High quality ASIC sensors with  **IO-Link** interface



### PRODUCT OVERVIEW

	 <b>IO-Link</b>			
Housing size mm	M5	M8	M12	M18
Classics (s <sub>n</sub> mm)	0.8	4	2...4	5

### ACCESSORIES

Go to page 298 to see all the accessories

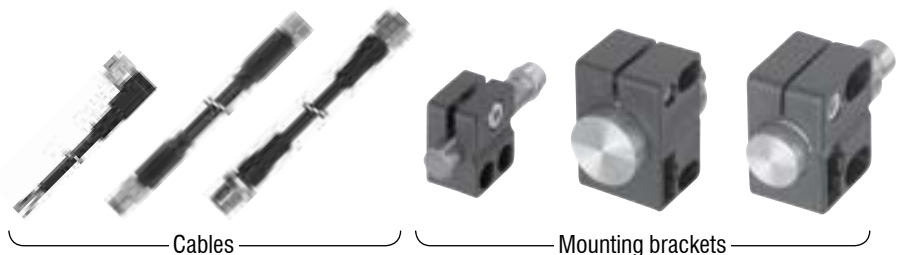

# INDUCTIVE SENSORS EXTRA TEMPERATURE



## COMMON FEATURES

<b>Supply Voltage range</b>	10 ... 30 VDC
<b>Output</b>	PNP NO*

\* Other types available: PNP NC, NPN NC

\*\* Pigtail versions available

## OUTPUT

DW-A[x]-60[x]		<b>Output</b>
<b>Connection</b>		[1] NPN NO [3] PNP NO
[D] Cable [S] Connector [V] Pigtail		[2] NPN NC [4] PNP NC

Reference key on page 116

## ACCESSORIES

- A** Group A: M8 3-pin  
Sub-group: Field attachable connectors  
Sub-group: Distribution boxes
- B** Group B: M8 4-pin
- C** Group C: M12 4-pin  
Sub-group: Field attachable connectors  
Sub-group: Distribution boxes
- D** Group D: M12 AC/DC 3-pin
- E** Group E: Universal mounting brackets  
Sub-group: Mechanical stops
- F** Group F: Photoelectric mounting brackets
- G** Group G: Photoelectric reflectors
- H** Group H: Sensor tester

Go to page 298 for details



**CABLES**  
Cable lengths available:  
2 m, 5 m, 10 m  
other customised lengths possible













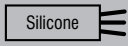

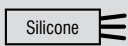

## FAMILY

OPERATING DISTANCE (mm)	HOUSING SIZE (mm)	HOUSING LENGTH (mm)	HOUSING MATERIAL
0.8	M5	25	Stainless steel V2A
0.8	M5	25	Stainless steel V2A
4	M8	36	Stainless steel V2A
4	M12	44.3	Nickel-plated brass
2	M12	50	Nickel-plated brass
5	M18	35	Chrome-plated brass

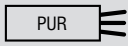
## CLASSICS – SERIES 600

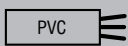

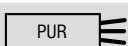

CABLE**	CONNECTOR**	IO-Link	SWITCHING FREQUENCY (Hz)	MOUNTING		AMBIENT TEMPERATURE	DEGREE OF PROTECTION	PART REFERENCE*	ACCESSORIES (SEE PAGE 86)
				EMB. 	NON-EMB. 				
			5,000	Embed.		-25 ... +120°C	IP67	DW-AD-601-M5-735	
			5,000	Embed.		-25 ... +120°C	IP67	DW-AD-603-M5-735	
			3,500	Non-embed.		0 ... +85°C	IP67	DW-AS-633-M8-732	
			2,000	Non-embed.		-25 ... +100°C	IP67	DW-AD-613-M12-733	
			3,000	Embed.		-25 ... +100°C	IP67	DW-AD-603-M12-734	
			2,000	Embed.		-40 ... +100°C	IP67	DW-AD-603-M18-718	





## APPLICATION

### High Temperature inductive sensors monitor position of fire-proof ventilation dampers

A manufacturer of fire-resistant air dampers for tunnel ventilation uses High Temperature inductive sensors to monitor damper position. They provide feedback to the ventilation control center, which adjusts dampers and fans as necessary in both normal and emergency operation. For reliable operation at temperatures up to 230°C (446°F), sensor electronics are built into a separate M12 stainless-steel housing.

## INDUSTRIES

Automotive production and supply, paint shops, surface treatment, bakery equipment, food and beverage



*Automated bakery equipment*



*Paintshop in automotive industry*



*Automotive production and supply*



*Brewery production equipment*

# HIGH TEMPERATURE INDUCTIVE SENSORS

TEMPERATURE RESISTANT  
UP TO +230°C (+446°F)

Exceptional working conditions demand uncompromising performance, and Contrinex **High Temperature** inductive sensors deliver in every respect. Designed for continuous operation at temperatures up to 180°C (230°C with remote electronics), this range is ideal for the harshest environments, including automotive paint shops, metal-treatment plants and glass manufacturing.

## KEY ADVANTAGES

- ✓ Highest long-term stability due to fully potted electronics
- ✓ Long sensor life
- ✓ Reliable sensing in high-temperature applications
- ✓ Compact construction with integral amplifier for temperatures up to +180°C (+356°F)
- ✓ External amplifier module for temperatures up to +230°C (+446°F)



## PRODUCT OVERVIEW

Housing size mm	M8	M12	M18	M30	M50
Classics (s <sub>n</sub> mm)	2	3/4	5	10/15	25

## ACCESSORIES

Go to page 298 to see all the accessories

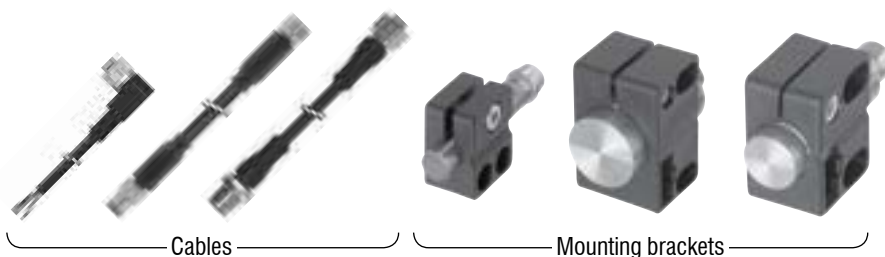

Cables

Mounting brackets

# INDUCTIVE SENSORS HIGH TEMPERATURE



## COMMON FEATURES

Supply Voltage range	10 ... 30 VDC
Output	PNP NO*

\*Other types available: PNP NC, NPN NC

## OUTPUT

DW-A[x]-60[x]		Output	
Connection		[1] NPN NO	[3] PNP NO
[D] Cable	[S] Connector	[V] Pigtail	[2] NPN NC
			[4] PNP NC

Reference key on page 116

## ACCESSORIES

- A** Group A: M8 3-pin  
Sub-group: Field attachable connectors  
Sub-group: Distribution boxes
- B** Group B: M8 4-pin
- C** Group C: M12 4-pin  
Sub-group: Field attachable connectors  
Sub-group: Distribution boxes
- D** Group D: M12 AC/DC 3-pin
- E** Group E: Universal mounting brackets  
Sub-group: Mechanical stops
- F** Group F: Photoelectric mounting brackets
- G** Group G: Photoelectric reflectors
- H** Group H: Sensor tester

Go to page 298 for details













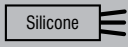

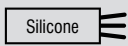



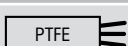

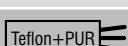

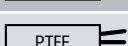



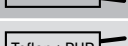



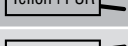

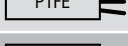
**CABLES**  
Cable lengths available:  
2 m, 5 m, 10 m  
other customised lengths possible

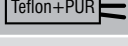
## FAMILY

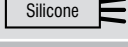
OPERATING DISTANCE (mm)	HOUSING SIZE (mm)	HOUSING LENGTH (mm)	HOUSING MATERIAL
2	M8	60	Stainless steel V2A
3	M12	59	Stainless steel V2A
4	M12	63	Stainless steel V2A
5	M18	82	Stainless steel V2A
5	M18	76	Stainless steel V2A
8	M18	82	Stainless steel V2A
10	M30	72	Stainless steel V2A
10	M30	72	Stainless steel V2A
15	M30	83	Stainless steel V2A
15	M30	83	Stainless steel V2A
15	M30	83	Stainless steel V2A
20	M50	76	Stainless steel V2A
20	M50	55	Stainless steel V2A
25	M50	68	Stainless steel V2A
25	M50	76	Stainless steel V2A

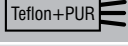
CLASSICS - SERIES 600

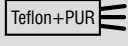

CABLE	CONNECTION	SWITCHING FREQUENCY (Hz)	MOUNTING		AMBIENT TEMPERATURE	DEGREE OF PROTECTION	PART REFERENCE*	ACCESSORIES (SEE PAGE 90)
			EMB. 	NON-EMB. 				
 Silicone	Silicone, 2 m, 3 wire	600	Embed.		0...+140°C	IP67	<b>DW-HD-623-M8-100</b>	
 Silicone	Silicone, 2 m, 3 wire	500	Embed.		0...+150°C	IP67	<b>DW-HD-603-M12-200</b>	
 Silicone	Silicone, 2 m, 3 wire	500	Non-Embed.		0...+150°C	IP67	<b>DW-HD-613-M12-200</b>	
 PTFE	PTFE, 2 m, 3 wire	400	Embed.		0...+180°C	IP67	<b>DW-HD-603-M18-310</b>	
 Teflon+PUR	PTFE, 3 m + PUR, 2 m, 3 wire	300	Embed.		0...+230°C	IP67	<b>DW-HD-603-M18-411</b>	
 PTFE	PTFE, 2 m, 3 wire	400	Non-embed.		0...+180°C	IP67	<b>DW-HD-613-M18-310</b>	
 PTFE	PTFE, 2 m, 3 wire	200	Embed.		0...+180°C	IP67	<b>DW-HD-603-M30-310</b>	
 Teflon+PUR	PTFE, 3 m + PUR, 2 m, 3 wire	200	Embed.		0...+230°C	IP67	<b>DW-HD-603-M30-411</b>	
 Teflon+PUR	PTFE, 3 m + PUR, 2 m, 3 wire	150	Non-embed.		0...+230°C	IP67	<b>DW-HD-613-M30-411</b>	
 PTFE	PTFE, 2 m, 3 wire	200	Non-embed.		0...+180°C	IP67	<b>DW-HD-613-M30-310</b>	
 Teflon+PUR	PTFE, 5 m + PUR, 2 m, 3 wire	150	Non-embed.		0...+230°C	IP67	<b>DW-HD-613-M30-508</b>	
 Silicone	Silicone, 2 m, 3 wire	100	Quasi-embed.		0...+180°C	IP67	<b>DW-HD-603-M50-300</b>	
 Teflon+PUR	PTFE, 3 m + PUR, 2 m, 3 wire	150	Quasi-embed.		0...+230°C	IP67	<b>DW-HD-603-M50-411</b>	
 Teflon+PUR	PTFE, 3 m + PUR, 2 m, 3 wire	150	Non-Embed.		0...+230°C	IP67	<b>DW-HD-613-M50-411</b>	
 Silicone	Silicone, 2 m, 3 wire	100	Non-embed.		0...+180°C	IP67	<b>DW-HD-613-M50-300</b>	



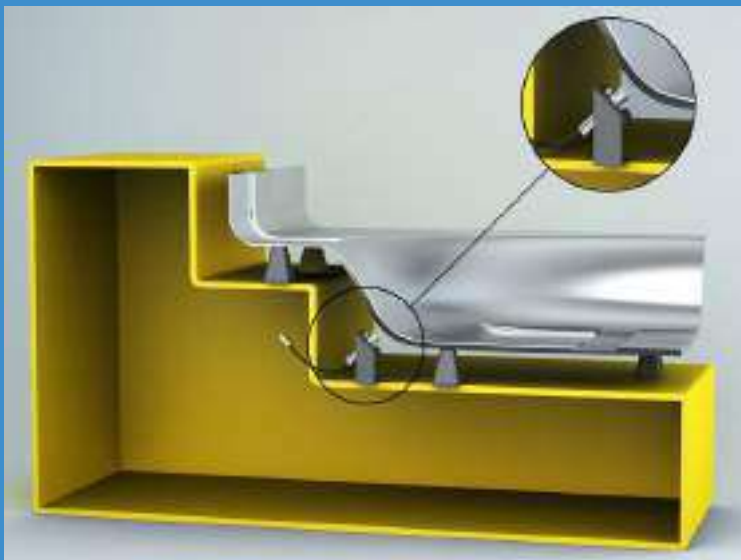

## APPLICATION

### Presence sensing ensures correct part placement on welding machine

Weld-Immune inductive sensors ensure that metal panels are correctly located on fixtures prior to welding. The anti-spatter coating, weld-field immunity and impact resistance of these sensors ensure that operation is reliable and downtime negligible, despite the harsh environment. Sensor service-life is increased, while maintenance costs are reduced significantly.

## INDUSTRIES

Automotive production and supply, welding equipment



*Welding cell in automotive factory*



*OEM welding equipment*



*Automotive production and supply*



*Welding equipment*

# WELD-IMMUNE INDUCTIVE SENSORS

## REVOLUTIONARY PROTECTION FOR LONG LIFE

Contrinex **Weld-Immune** inductive sensors are ideal for the hostile working environments found in automotive factories and other industrial welding plants. One-piece, stainless-steel construction and best-in-class sensing ranges of up to 16 mm prevent the risk of collision damage. Types with an ACTIVSTONE® coating offer the highest level of weld-spatter resistance, reducing cleaning and maintenance costs.

### KEY ADVANTAGES

- ✓ Exceptionally resistant to weld spatter in spot, MIG and MAG applications thanks to Activstone® coating protection
- ✓ Resistant to magnetic interference from medium-frequency weld fields, current up to 15 kA
- ✓ Maximum impact resistance on the Full Inox sensor with one-piece stainless-steel housings and Condet® technology
- ✓ Protection beyond the sensor with coated mounting brackets, spatter-resistant cable and protective tubes



### PRODUCT OVERVIEW

		IO-Link				
Housing size mm		M8	M12	M18	M30	C23
s <sub>n</sub> mm	Full Inox	3	6	10	16	7
	Classics	2	4	8	–	–

### ACCESSORIES

Go to pages 100 and 101 to see all the accessories

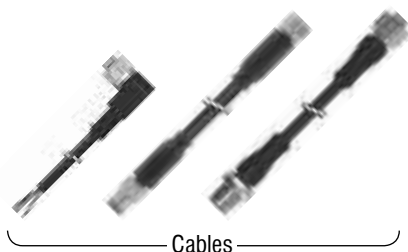

# CHALLENGES

# SOLUTIONS



## WELD SPATTER

- Reduced sensor performance
- Spatter accumulation
- Difficulty replacing sensors

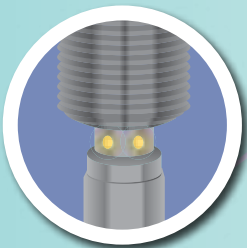

## MAGNETIC FIELDS

- Interference with inductive sensor
- False triggering
- Sensor output locking on



## MOVING PARTS

- Mechanical impact with moving workpieces
- Damage to ferrite, electronics and housing
- Frequent machine downtime



## ANTI-SPATTER COATING

**Activstone®** coating on all external surfaces resists weld spatter in spot, MIG and MAG applications.



## WELD-FIELD IMMUNITY

Contrinex sensors resist magnetic interference from medium-frequency weld fields, current up to 15 kA.



## IMPACT RESISTANCE

With one-piece stainless-steel housings and **Condet®** technology, Full Inox sensors offer maximum impact resistance.

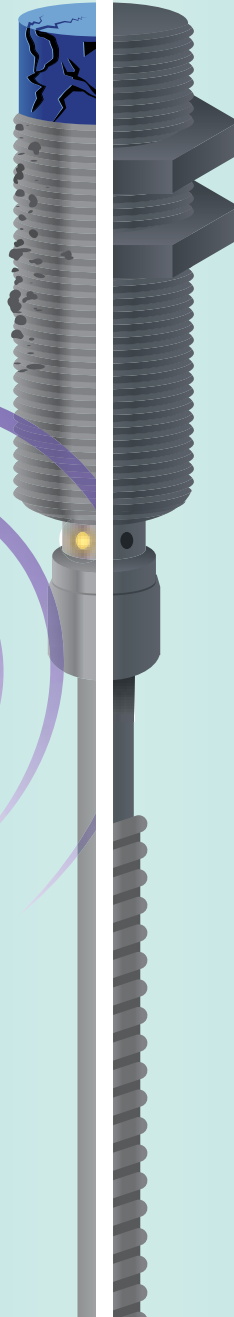





## ACCESSORIES

For extensive protection, use **Activstone®** coated mounting brackets, spatter-resistant cables and protective tubes. Uncoated brackets are also available.



# SENSOR SELECTOR

		FULL INOX (SERIES 700)		CLASSICS (SERIES 600)	
		FULL INOX HOUSING + DOUBLE OPERATING DISTANCE		PLASTIC FACE + NORMAL OPERATING DISTANCE	
		COATED	UNCOATED	COATED	UNCOATED
					
KEY FEATURES	Weld-spatter resistance	✓		✓	
	Magnetic-field immunity	✓	✓	✓	✓
	Impact resistance	✓	✓		
	Long operating distance	✓	✓		
	Factor 1 on steel and aluminum	✓	✓		
SIZE	M8	✓	✓	✓	✓
	M12	✓	✓	✓	✓
	M18	✓	✓	✓	✓
	M30	✓	✓		
	C23	✓			
CONNECTIVITY	Connector M12, 4-pin	✓	✓	✓	✓
	Pigtail M12, 3-pin	✓	✓		
ENCLOSURE RATING	IP67	✓	✓	✓	✓
	IP68	✓	✓		
	IP69K	✓	✓		
HOUSING	Embeddable	✓	✓	✓	✓
	One-piece stainless steel housing	✓	✓		
	Stainless steel housing and plastic sensing face			✓	✓

# INDUCTIVE SENSORS WELD-IMMUNE



## COMMON FEATURES

Supply Voltage range	10 ... 30 VDC
----------------------	---------------

## OUTPUT

DW-A[x]-70[x]		Output	
Connection		[1] NPN NO	[3] PNP NO
[D] Cable	[S] Connector	[2] NPN NC	[4] PNP NC
[V] Pigtail			

Reference key on page 116

## ACCESSORIES

Go to pages 100 and 101 for details

FAMILY	OPERATING DISTANCE (mm)	HOUSING SIZE (mm)	HOUSING LENGTH (mm)	HOUSING MATERIAL	
FULL INOX – SERIES 700 COATED	3	M8	60	Stainless steel V2A	
	3	M8	45	Stainless steel V2A	
	3	M8	45	Stainless steel V2A	
	6	M12	60	Stainless steel V2A	
	6	M12	50	Stainless steel V2A	
	6	M12	45	Stainless steel V2A	
	10	M18	63.5	Stainless steel V2A	
	10	M18	50	Stainless steel V2A	
	10	M18	50	Stainless steel V2A	
	16	M30	63.5	Stainless steel V2A	
	16	M30	63.5	Stainless steel V2A	
	16	M30	63.5	Stainless steel V2A	
	7	32 × 20 (C23)	8	Stainless steel V2A	
	7	32 × 20 (C23)	8	Stainless steel V2A	
	FULL INOX – SERIES 700 UNCOATED	3	M8	60	Stainless steel V2A
		3	M8	45	Stainless steel V2A
3		M8	45	Stainless steel V2A	
6		M12	60	Stainless steel V2A	
6		M12	50	Stainless steel V2A	
6		M12	50	Stainless steel V2A	
10		M18	63.5	Stainless steel V2A	
10		M18	50	Stainless steel V2A	
10		M18	50	Stainless steel V2A	
16		M30	63.5	Stainless steel V2A	
16		M30	63.5	Stainless steel V2A	
16		M30	63.5	Stainless steel V2A	



CABLE	CONNECTOR	IO-Link	SWITCHING FREQUENCY (Hz)	MOUNTING		AMBIENT TEMPERATURE	DEGREE OF PROTECTION	PART REFERENCE
				EMB.	NON-EMB.			
	M12	IO-Link	15	Embed.		-25 ... +85°C	IP68 / IP69K	DW-AS-703-M8-697
0.2 m PUR	M12		15	Embed.		-25 ... +85°C	IP68 / IP69K	DW-AV-701-M8-696
0.2 m PUR	M12	IO-Link	15	Embed.		-25 ... +85°C	IP68 / IP69K	DW-AV-703-M8-696
	M12	IO-Link	15	Embed.		-25 ... +85°C	IP68 / IP69K	DW-AS-703-M12-697
0.2 m PUR	M12		15	Embed.		-25 ... +85°C	IP68 / IP69K	DW-AV-701-M12-696
0.2 m PUR	M12	IO-Link	15	Embed.		-25 ... +85°C	IP68 / IP69K	DW-AV-703-M12-696
	M12	IO-Link	15	Embed.		-25 ... +85°C	IP68 / IP69K	DW-AS-703-M18-697
0.2 m PUR	M12		15	Embed.		-25 ... +85°C	IP68 / IP69K	DW-AV-701-M18-696
0.2 m PUR	M12	IO-Link	15	Embed.		-25 ... +85°C	IP68 / IP69K	DW-AV-703-M18-696
	M12	IO-Link	15	Embed.		-25 ... +85°C	IP68 / IP69K	DW-AS-703-M30-697
0.2 m PUR	M12	IO-Link	15	Embed.		-25 ... +85°C	IP68 / IP69K	DW-AV-703-M30-696
0.2 m PUR	M12		15	Embed.		-25 ... +85°C	IP68 / IP69K	DW-AV-701-M30-696
0.2 m PUR	M12	IO-Link	15	Embed.		-25 ... +85°C	IP68 / IP69K	DW-AV-703-C23-696
0.2 m PUR	M12		15	Embed.		-25 ... +85°C	IP68 / IP69K	DW-AV-701-C23-696
	M12	IO-Link	15	Embed.		-25 ... +85°C	IP68 / IP69K	DW-AS-703-M8-694
0.2 m PUR	M12		15	Embed.		-25 ... +85°C	IP68 / IP69K	DW-AV-701-M8-695
0.2 m PUR	M12	IO-Link	15	Embed.		-25 ... +85°C	IP68 / IP69K	DW-AV-703-M8-695
	M12	IO-Link	15	Embed.		-25 ... +85°C	IP68 / IP69K	DW-AS-703-M12-673
0.2 m PUR	M12		15	Embed.		-25 ... +85°C	IP68 / IP69K	DW-AV-701-M12-692
0.2 m PUR	M12	IO-Link	15	Embed.		-25 ... +85°C	IP68 / IP69K	DW-AV-703-M12-695
	M12	IO-Link	15	Embed.		-25 ... +85°C	IP68 / IP69K	DW-AS-703-M18-673
0.2 m PUR	M12		15	Embed.		-25 ... +85°C	IP68 / IP69K	DW-AV-701-M18-692
0.2 m PUR	M12	IO-Link	15	Embed.		-25 ... +85°C	IP68 / IP69K	DW-AV-703-M18-695
	M12	IO-Link	15	Embed.		-25 ... +85°C	IP68 / IP69K	DW-AS-703-M30-673
0.2 m PUR	M12	IO-Link	15	Embed.		-25 ... +85°C	IP68 / IP69K	DW-AV-703-M30-695
0.2 m PUR	M12		15	Embed.		-25 ... +85°C	IP68 / IP69K	DW-AV-701-M30-695

# INDUCTIVE SENSORS WELD-IMMUNE



## COMMON FEATURES

Supply Voltage range 10 ... 30 VDC

## OUTPUT

DW-A[x]-62[x]

**Connection**  
 [D] Cable [S] Connector [V] Pigtail

**Output**  
 [1] NPN NO [3] PNP NO  
 [2] NPN NC [4] PNP NC

Reference key on page 116

## ACCESSORIES

Go to pages 100 and 101 for details

FAMILY	OPERATING DISTANCE (mm)	HOUSING SIZE (mm)	HOUSING LENGTH (mm)	HOUSING MATERIAL
CLASSICS – SERIES 600 COATED	2	M8	66	Stainless steel V2A
	4	M12	60	Stainless steel V2A
	8	M18	63.5	Stainless steel V2A
CLASSICS – SERIES 600 UNCOATED	2	M8	66	Stainless steel V2A
	4	M12	60	Stainless steel V2A
	8	M18	63.5	Stainless steel V2A



CABLE	CONNECTOR	IO-Link	SWITCHING FREQUENCY (Hz)	MOUNTING		AMBIENT TEMPERATURE	DEGREE OF PROTECTION	PART REFERENCE
				EMB.	NON-EMB.			
	M12		15	Embed.		-25 ... +70°C	IP67	DW-AS-623-M8-697
	M12		15	Embed.		-25 ... +70°C	IP67	DW-AS-623-M12-697
	M12		15	Embed.		-25 ... +70°C	IP67	DW-AS-623-M18-697

	M12		15	Embed.		-25 ... +70°C	IP67	DW-AS-623-M8-694
	M12		15	Embed.		-25 ... +70°C	IP67	DW-AS-623-M12-694
	M12		15	Embed.		-25 ... +70°C	IP67	DW-AS-623-M18-694



## PROTECTION BEYOND THE SENSOR

Reduce downtime with accessories that protect the surrounding installation against the challenges of welding environments. Mounting brackets with ACTIVSTONE® coating resist accumulation of weld spatter and so reduce the need for cleaning. A special range of stainless-steel mounting brackets offers exceptionally high mechanical and chemical resistance.



For optimal protection use the long-life cables in spatter-resistant PUR and the high-temperature, spatter-resistant protective tubes to enhance machine availability.

## WELD-IMMUNE MOUNTING BRACKETS





	PART REFERENCE	MATERIAL	DIMENSIONS (mm)	COMPATIBLE WITH						
				SENSOR SIZE				CLASSICS SERIES 600	FULL INOX SERIES 700	
				M8	M12	M18	M30			
COATED		ASU-0041-120	Steel	L = 38.1 W = 34.9 H = 19.05		✓			✓	✓
		ASU-0041-180	Steel	L = 38.1 W = 38.1 H = 25.4			✓		✓	✓
		ASU-0041-300	Steel	L = 44.45 W = 59.94 H = 38.1				✓	✓	✓
UNCOATED		ASU-3012-080	Stainless steel	SW17 L = 32.4	✓					✓
		ASU-3012-120	Stainless steel	SW22 L = 33.8		✓				✓
		ASU-3012-180	Stainless steel	SW30 L = 33.8			✓			✓



## SPATTER-RESISTANT CONNECTING CABLES

	PART REFERENCE	SOCKET			CABLE	
		SIZE	PINS	CONFIG.	MATERIAL	LENGTH
	S12-3FUG-020-NNWN	M12	3	straight	PUR	2 m
	S12-3FUG-050-NNWN	M12	3	straight	PUR	5 m
	S12-3FUW-020-NNWN	M12	3	right angle	PUR	2 m
	S12-3FUW-050-NNWN	M12	3	right angle	PUR	5 m
	S12-3FUG-020-NNWN-12MG	M12	3	straight	PUR	2 m + M12 plug
	S12-3FUG-050-NNWN-12MG	M12	3	straight	PUR	5 m + M12 plug

## SPATTER-RESISTANT PROTECTIVE TUBES

	PART REFERENCE	MATERIAL	INNER DIAMETER	OUTER DIAMETER	LENGTH
	APT-0000-010	PTFE	3.5 mm	6 mm	1 m
	APT-0000-100	PTFE	3.5 mm	6 mm	10 m
	APT-0001-010	PTFE	6.5 mm	10 mm	1 m
	APT-0001-100	PTFE	6.5 mm	10 mm	10 m
	APT-0002-100	PTFE	13 mm	17.5 mm	10 m
	APT-0003-100	PTFE	19 mm	23.5 mm	10 m

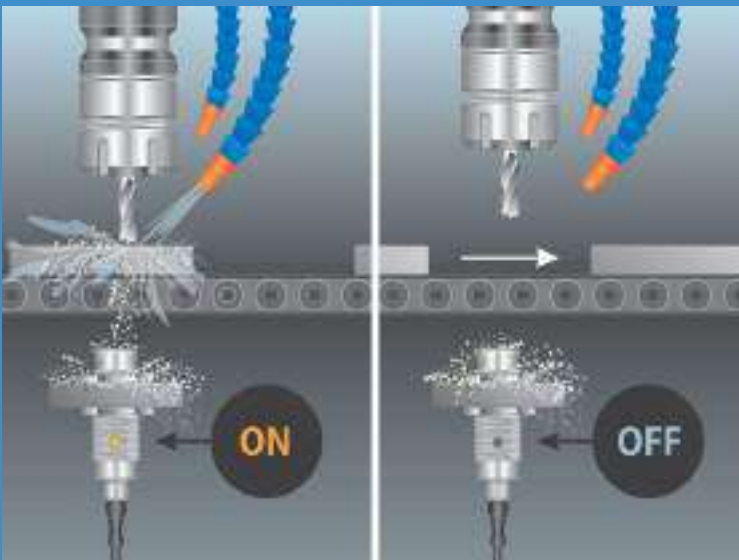

## APPLICATION

**Sensors with full-metal housing withstand aggressive fluids and hot metal chips in machine tools**

Chip-Immune sensors on machine tools control the position of automatically fed workpieces as well as the workpiece clamping system. They are insensitive to dirt, heat, metal chips and dust. They also resist mechanical impacts, aggressive cutting oils, drilling emulsions and cleaning agents.

## INDUSTRIES

Automotive production and supply, machine tool



*Tools for machining metal parts*



*Metal recycling equipment*



*Machine tools*



*Automotive production and supply*

# CHIP-IMMUNE INDUCTIVE SENSORS

## FOR THE HARSHTEST MACHINING ENVIRONMENTS

**Chip-Immune** sensors prevent false switching due to metal debris in milling, drilling or grinding processes. Even when sensors are covered with metal chips, they reliably detect steel or aluminum objects. With one-piece stainless-steel housings, an **IP68/IP69K** protection rating and operating temperatures from  $-25^{\circ}\text{C}$  to  $+85^{\circ}\text{C}$  ( $-13^{\circ}\text{F}$  to  $+185^{\circ}\text{F}$ ), they are ideal for the harshest machining environments.

### KEY ADVANTAGES

- ✓ Detection not influenced by chips of steel, stainless steel, aluminum, brass, copper or titanium
- ✓ Detection of targets made of the above metals
- ✓ Robust, one-piece stainless-steel housing, protection rating IP68 and IP69K
- ✓ Temperature range  $-25^{\circ}\text{C} \dots +85^{\circ}\text{C}$  ( $-13^{\circ}\text{F} \dots +185^{\circ}\text{F}$ )
- ✓ Size M12, M18 and M30
- ✓ Operating distances up to 12 mm
- ✓  IO-Link



### PRODUCT OVERVIEW

	 IO-Link		
Housing size mm	M12	M18	M30
Full Inox (s <sub>n</sub> mm)	3	5	12

### ACCESSORIES

Go to page 298 to see all the accessories

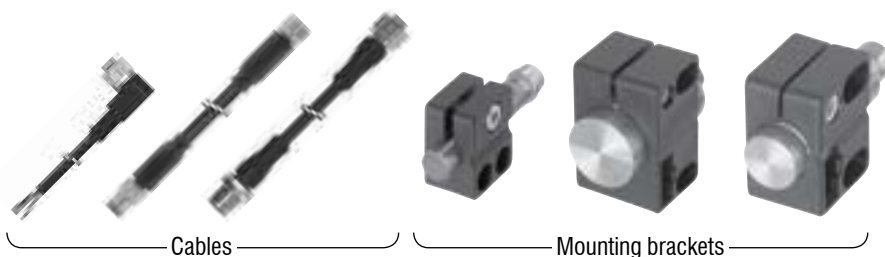

# INDUCTIVE SENSORS CHIP-IMMUNE



## COMMON FEATURES

**Supply Voltage range** 10 ... 30 VDC

\*\* Pigtail versions available

## OUTPUT

DW-A[x]-70[x]

**Connection**  
[D] Cable [S] Connector [V] Pigtail

**Output**  
[1] NPN NO [3] PNP NO

Reference key on page 116

## ACCESSORIES

- A** Group A: M8 3-pin  
Sub-group: Field attachable connectors  
Sub-group: Distribution boxes
- B** Group B: M8 4-pin
- C** Group C: M12 4-pin  
Sub-group: Field attachable connectors  
Sub-group: Distribution boxes
- D** Group D: M12 AC/DC 3-pin
- E** Group E: Universal mounting brackets  
Sub-group: Mechanical stops
- F** Group F: Photoelectric mounting brackets
- G** Group G: Photoelectric reflectors
- H** Group H: Sensor tester

Go to page 298 for details



## CABLES

Cable lengths available:  
2 m, 5 m, 10 m  
other customised lengths possible

FAMILY	OPERATING DISTANCE (mm)	HOUSING SIZE (mm)	HOUSING LENGTH (mm)	HOUSING MATERIAL
FULL INOX – SERIES 700	3	M12	60	Stainless steel V2A
	3	M12	60	Stainless steel V2A
	5	M18	63.5	Stainless steel V2A
	5	M18	63.5	Stainless steel V2A
	12	M30	63.5	Stainless steel V2A
	12	M30	63.5	Stainless steel V2A

FULL INOX – SERIES 700





CABLE **	CONNECTOR **	IO-Link	SWITCHING FREQUENCY (Hz)	MOUNTING		AMBIENT TEMPERATURE	DEGREE OF PROTECTION	PART REFERENCE	ACCESSORIES (SEE PAGE 104)
				EMB.	NON-EMB.				
	M12		400	Non-embed.		-25 ... +85°C	IP68 / IP69K	DW-AS-711-M12-967	C E H
	M12	IO-Link	400	Non-embed.		-25 ... +85°C	IP68 / IP69K	DW-AS-713-M12-967	C E H
	M12		200	Non-embed.		-25 ... +85°C	IP68 / IP69K	DW-AS-711-M18-967	C E H
	M12	IO-Link	200	Non-embed.		-25 ... +85°C	IP68 / IP69K	DW-AS-713-M18-967	C E H
	M12		90	Non-embed.		-25 ... +85°C	IP68 / IP69K	DW-AS-711-M30-967	C E H
	M12	IO-Link	90	Non-embed.		-25 ... +85°C	IP68 / IP69K	DW-AS-713-M30-967	C E H





## APPLICATION

### Double-sheet sensing for deep-drawing press

A producer of deep-drawn metal parts for the automotive industry uses double-sheet sensing to prevent costly tool damage and downtime. An inductive sensor checks sheet metal as it is presented to the forming press. If it detects that two or more sheets have stuck together, the machine control system rejects the material and prevents the press from operating.

## INDUSTRIES

Automotive production and supply, machine tool, surface treatment, stamping and forming, aluminum industry



*Robot handling of sheet metal*



*Double-feed prevention for formed parts*



*Aluminum industry*



*Automotive production and supply*

# DOUBLE-SHEET INDUCTIVE SENSORS

## DOUBLE-SHEET DETECTION IN METALWORKING

For double-sheet detection, sensors from the **Full Inox** family are used. Its inductive technology enables discrimination between one and two conductive metal sheets of a defined thickness, achieving sensitivity of 0.8–1.2 mm per sheet. This discrimination aids in the prevention of double feeds into blanking and forming processes which ultimately saves damage to tooling.

### KEY ADVANTAGES

- ✓ Double-sheet detection (steel and aluminum) with sensitivity of 0.8–1.2 mm per sheet
- ✓ Full Inox: extremely robust one-piece stainless-steel housing
- ✓ Corrosion resistant
- ✓ IP68 and IP69K
- ✓ Pressure resistant up to 80 bar



## PRODUCT OVERVIEW

PART REFERENCE: DW-AS-713-M30-618

SERIES 700	OPERATING DISTANCE (mm)	HOUSING SIZE (mm)	HOUSING LENGTH (mm)	HOUSING MATERIAL	CONNECTOR	SWITCHING FREQUENCY (Hz)	MOUNTING	AMBIENT TEMP.	DEGREE OF PROTECTION
	4	<b>M30</b>	63.5	Stainless steel V2A	 M12	10	Non-embed.	–25 ... +85°C	IP68 / IP69K

## ACCESSORIES

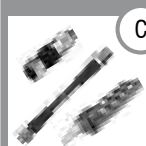

**C** Group C: M12 4-pin  
Sub-group: Field attachable connectors  
Sub-group: Distribution boxes

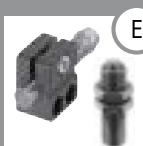

**E** Group E: Universal mounting brackets  
Sub-group: Mechanical stops



**H** Group H: Sensor tester

Go to page 298 for details



## APPLICATION

### Rugged inductive sensor measures rotation velocity of wind turbine blades

Modern wind turbines operate continuously in remote, highly demanding environments. Exceptional reliability is essential as opportunities for maintenance are limited. Turbine rotation velocity is a key operating parameter and manufacturers require robust sensor systems that provide accurate measurement in real-time. Rugged presence-sensing systems withstand harsh exposed conditions, both onshore and offshore, while delivering the required accuracy and reliability.

## INDUSTRIES

Maritime, machine tool, energy, vehicles, ships, port and offshore installations



*Wear monitoring, propeller shaft*



*Machinery spaces in ships*



*Machine tools*



*Offshore installations*

# MARITIME INDUCTIVE SENSORS

## FOR SHIPS, PORTS AND OFFSHORE

The **Maritime** range of embeddable inductive sensors, certified by DNV, offers unrivaled performance features based on **Full Inox** technology. With a one-piece housing in V4A/AISI 316L stainless steel and an enclosure rating of **IP68/IP69K**, they are not only impervious, but also corrosion-proof and resistant to salt water. Their EMC protection also meets specific maritime requirements.

### KEY ADVANTAGES

- ✓ GL approved, class DNV-GL-CG-0339
- ✓ Extremely rugged sensors, fit for Industry 4.0
- ✓ Special EMC protection
- ✓ Resistant to corrosion and salt water
- ✓ Impervious, enclosure rating IP68 or IP69K
- ✓ Temperature range  $-25 \dots +85^{\circ}\text{C}$  ( $-13 \dots +185^{\circ}\text{F}$ )
- ✓ Full Inox types: one-piece stainless-steel housing (V4A/AISI 316L), factor 1 on steel and aluminum
- ✓ Pressure-resistance available up to 500 bar (800 bar peak)
- ✓  **IO-Link** interface



### PRODUCT OVERVIEW

		 IO-Link					
Housing size mm		M10	M12	M18	M30	P12G	C23
s <sub>n</sub> mm	Classics	0.6	–	–	–	–	–
	Full Inox	–	6	10	20	1.5	7

### ACCESSORIES

Go to page 298 to see all the accessories

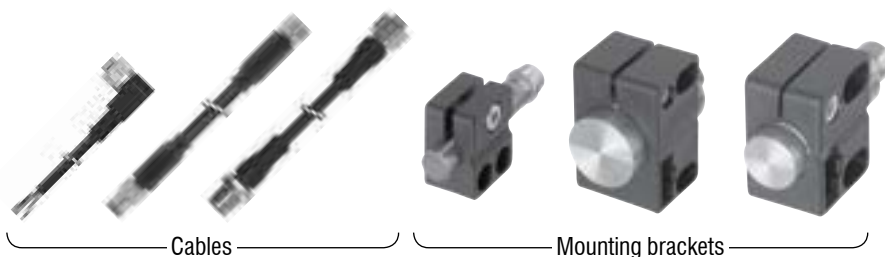

# INDUCTIVE SENSORS MARITIME



## COMMON FEATURES

Supply Voltage range	10 ... 30 VDC
Output	PNP NO

## OUTPUT

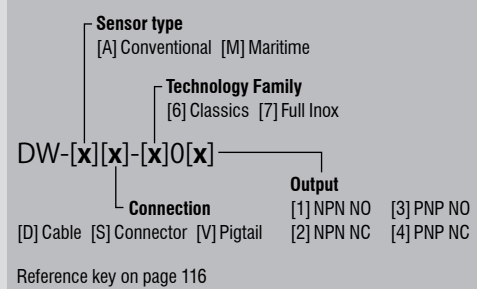

## ACCESSORIES

- A** Group A: M8 3-pin  
Sub-group: Field attachable connectors  
Sub-group: Distribution boxes
- B** Group B: M8 4-pin
- C** Group C: M12 4-pin  
Sub-group: Field attachable connectors  
Sub-group: Distribution boxes
- D** Group D: M12 AC/DC 3-pin
- E** Group E: Universal mounting brackets  
Sub-group: Mechanical stops
- F** Group F: Photoelectric mounting brackets
- G** Group G: Photoelectric reflectors
- H** Group H: Sensor tester

Go to page 298 for details

**CABLES**  
Cable lengths available:  
2 m, 5 m, 10 m  
other customised lengths possible

FAMILY	OPERATING DISTANCE (mm)	HOUSING SIZE (mm)	HOUSING LENGTH (mm)	HOUSING MATERIAL
CLASSICS SERIES 600	0.6	M10	35	Stainless steel V2A
	0.6	M10	35	Stainless steel V2A
FULL INOX – SERIES 700	1.5	M12	61	Stainless steel V4A
	1.5	M12	57.3	Stainless steel V4A
	6	M12	60	Stainless steel V4A
	6	M12	66.5	Stainless steel V4A
	10	M18	63.5	Stainless steel V4A
	10	M18	66.5	Stainless steel V4A
	20	M30	63.5	Stainless steel V4A
	20	M30	66.5	Stainless steel V4A
	7	32 × 20 (C23)	8	Stainless steel V4A
	7	32 × 20 (C23)	8	Stainless steel V4A



CABLE	CONNECTOR	IO-Link	SWITCHING FREQUENCY (Hz)	MOUNTING		AMBIENT TEMPERATURE	DEGREE OF PROTECTION	PART REFERENCE	ACCESSORIES (SEE PAGE 110)
				EMB. 	NON-EMB. 				
			2,500	Embed.		-25 ... +70°C	IP68	DW-AD-603-M10E-620	(H)
			2,500	Embed.		-25 ... +70°C	IP68	DW-AD-603-M10E-637	(H)
			850	Embed.		-25 ... +85°C	IP68 / IP69K	DW-MS-703-P12G	(C) (H)
			850	Embed.		-25 ... +85°C	IP68 / IP69K	DW-MD-703-P12G	(C) (H)
			600	Embed.		-25 ... +85°C	IP68 / IP69K	DW-MS-703-M12	(C) (E) (H)
			600	Embed.		-25 ... +85°C	IP68 / IP69K	DW-MD-703-M12	(E) (H)
			300	Embed.		-25 ... +85°C	IP68 / IP69K	DW-MS-703-M18-002	(C) (E) (H)
			300	Embed.		-25 ... +85°C	IP68 / IP69K	DW-MD-703-M18	(E) (H)
			100	Embed.		-25 ... +85°C	IP68 / IP69K	DW-MS-703-M30-002	(C) (E) (H)
			100	Embed.		-25 ... +85°C	IP68 / IP69K	DW-MD-703-M30	(E) (H)
			180	Embed.		-25 ... +85°C	IP68 / IP69K	DW-MD-703-C23	(H)
			180	Embed.		-25 ... +85°C	IP68 / IP69K	DW-MV-703-C23-276	(A) (H)

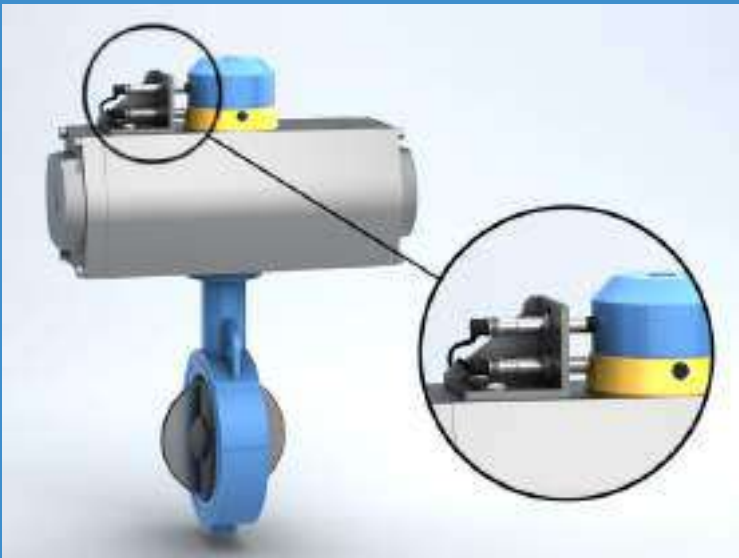

## APPLICATION

### Washdown inductive sensors monitor position of control valves during dairy-product processing

During manufacture of dairy products, raw milk travels between successive processes through stainless-steel pipework. Rotary-shaft control valves maintain process sequences correctly, ensuring that no cross-contamination occurs during CIP cleaning after each batch is completed. Robust washdown inductive sensors, mounted on existing rotary actuators, monitor control-valve status around the clock, providing real-time positional feedback to a plant-wide control system in a simple, cost-effective manner.

## INDUSTRIES

Food and beverage, packaging, logistics, materials handling, pharmaceutical industry, industrial cleaning systems



*Sorting conveyor for egg packaging*



*Brewery production equipment*



*Pharmaceutical industry*



*Automated laundry system*

# WASHDOWN INDUCTIVE SENSORS

## ECOLAB APPROVED FOR HARSHTEST CLEANING PROCESSES

**Washdown** inductive sensors are certified to operate continuously and reliably in the harsh conditions of the food, beverage and pharmaceutical industries, ensuring uninterrupted production. Rated to **IP68** and **IP69K**, they are pressure resistant up to **80 bar**, **food safe and corrosion resistant**; additionally Full Inox – Series 700 are **Ecolab** certified.

### KEY ADVANTAGES

- ✓ Corrosion resistant
- ✓ Food safe
- ✓ IP68/IP69K protection
- ✓  **IO-Link** interface
- ✓ Extremely rugged Full Inox types: one-piece stainless-steel housing, factor 1 on steel and aluminum
- ✓ Ecolab approved



### PRODUCT OVERVIEW

		 IO-Link		
Housing size mm		M12	M18	M30
s <sub>n</sub> mm	Classics	2	–	–
	Full Inox	6 ... 10	10 ... 20	20 ... 40

### ACCESSORIES

Go to page 298 to see all the accessories

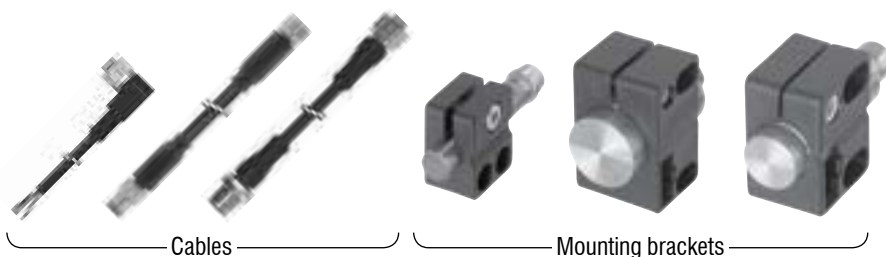

Cables

Mounting brackets

# INDUCTIVE SENSORS WASHDOWN



FAMILY	OPERATING DISTANCE (mm)	HOUSING SIZE (mm)	HOUSING LENGTH (mm)	HOUSING MATERIAL
CLASSICS SERIES 600	2	M12	60	Stainless steel V4A

## COMMON FEATURES

Supply Voltage range	10 ... 30 VDC
Output	PNP NO*

\* Other types available: PNP NC, NPN NC

## OUTPUT

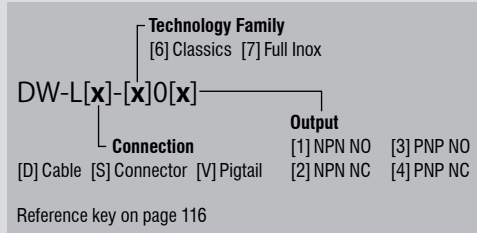

## ACCESSORIES

- A** Group A: M8 3-pin  
Sub-group: Field attachable connectors  
Sub-group: Distribution boxes
- B** Group B: M8 4-pin
- C** Group C: M12 4-pin  
Sub-group: Field attachable connectors  
Sub-group: Distribution boxes
- D** Group D: M12 AC/DC 3-pin
- E** Group E: Universal mounting brackets  
Sub-group: Mechanical stops
- F** Group F: Photoelectric mounting brackets
- G** Group G: Photoelectric reflectors
- H** Group H: Sensor tester

Go to page 298 for details

**CABLES**  
Cable lengths available:  
2 m, 5 m, 10 m  
other customised lengths possible

FULL INOX – SERIES 700	6	M12	60	Stainless steel V4A
	10	M12	60	Stainless steel V4A
	6	M12	66.5	Stainless steel V4A
	10	M12	66.5	Stainless steel V4A
	10	M18	63.5	Stainless steel V4A
	20	M18	63.5	Stainless steel V4A
	10	M18	66.5	Stainless steel V4A
	20	M18	66.5	Stainless steel V4A
	20	M30	63.5	Stainless steel V4A
	40	M30	63.5	Stainless steel V4A
	20	M30	66.5	Stainless steel V4A
40	M30	66.5	Stainless steel V4A	
20	M30	66.5	Stainless steel V4A	



CABLE	CONNECTOR	IO-Link	SWITCHING FREQUENCY (Hz)	MOUNTING		AMBIENT TEMPERATURE	DEGREE OF PROTECTION	PART REFERENCE*	ACCESSORIES (SEE PAGE 114)
				EMB.	NON-EMB.				
	M12	IO-Link	1,700	Embed.		-25 ... +120°C	IP68 / IP69K	DW-LS-603-M12	C E H
	M12	IO-Link	600	Embed.		-25 ... +85°C	IP68 / IP69K	DW-LS-703-M12	C E H
	M12	IO-Link	400	Non-embed.		-25 ... +85°C	IP68 / IP69K	DW-LS-713-M12	C E H
Teflon		IO-Link	600	Embed.		-25 ... +85°C	IP68 / IP69K	DW-LD-703-M12	E H
Teflon		IO-Link	400	Non-embed.		-25 ... +85°C	IP68 / IP69K	DW-LD-713-M12	E H
	M12	IO-Link	200	Embed.		-25 ... +85°C	IP68 / IP69K	DW-LS-703-M18-002	C E H
	M12	IO-Link	200	Non-embed.		-25 ... +85°C	IP68 / IP69K	DW-LS-713-M18-002	C E H
Teflon		IO-Link	200	Embed.		-25 ... +85°C	IP68 / IP69K	DW-LD-703-M18	E H
Teflon		IO-Link	200	Non-embed.		-25 ... +85°C	IP68 / IP69K	DW-LD-713-M18	E H
	M12	IO-Link	125	Embed.		-25 ... +85°C	IP68 / IP69K	DW-LS-703-M30-002	C E H
	M12	IO-Link	90	Non-embed.		-25 ... +85°C	IP68 / IP69K	DW-LS-713-M30-002	C E H
Teflon		IO-Link	125	Embed.		-25 ... +85°C	IP68 / IP69K	DW-LD-703-M30	E H
Teflon		IO-Link	90	Non-embed.		-25 ... +85°C	IP68 / IP69K	DW-LD-713-M30	E H
Teflon		IO-Link	100	Embed.		-25 ... +85°C	IP68 / IP69K	DW-LD-703-M30-220	E H



# INDUCTIVE SENSORS REFERENCE KEY

## DW-AD-503-M8E (-12X/-XXX)

### INDUCTIVE SENSOR DW

### SENSOR TYPE

Conventional	A
2-wire DC (NAMUR excepted)	D
High-temperature	H
Food and sea-water	L
Maritime	M

### CONNECTION

Cable	D
Connector	S
Cable + connector	V

### SERIES

500 / 520 (Extra Distance)	5
600 / 620 (Classics)	6
700 (Full Inox)	7
Embeddable / quasi-embeddable	0
Non-embeddable	1
Increased operating distance, (quasi-)embeddable	2
Increased operating distance, non-embeddable	3

### OUTPUT

NPN NO	1
NPN NC	2
PNP NO	3
PNP NC	4
PNP changeover	A
NPN changeover	B

### SHORT / SPECIAL EXECUTIONS

Series E (impervious)	E
Series 700P (all-metal and high-pressure resistant)	G

### HOUSING SIZE

Threaded	
M4	4
M5	5
M8	8
M12	12
M18	18
M30	30
M50	50

Smooth	
Ø3 mm	3
Ø4 mm	4
Ø6.5 mm	65
Ø8 mm	80
5 × 5 mm	5
8 × 8 mm	8
20 × 32 mm	23
40 × 40 mm	44

### HOUSING

Threaded cylindrical housing	M
Rectangular housing	C
Smooth cylindrical housing	0
High-pressure resistant	P

### OUTPUT

2-wire DC	
NO / NAMUR	5
NC	6

2-wire AC/DC	
NO	7
NC	8
Analog	9



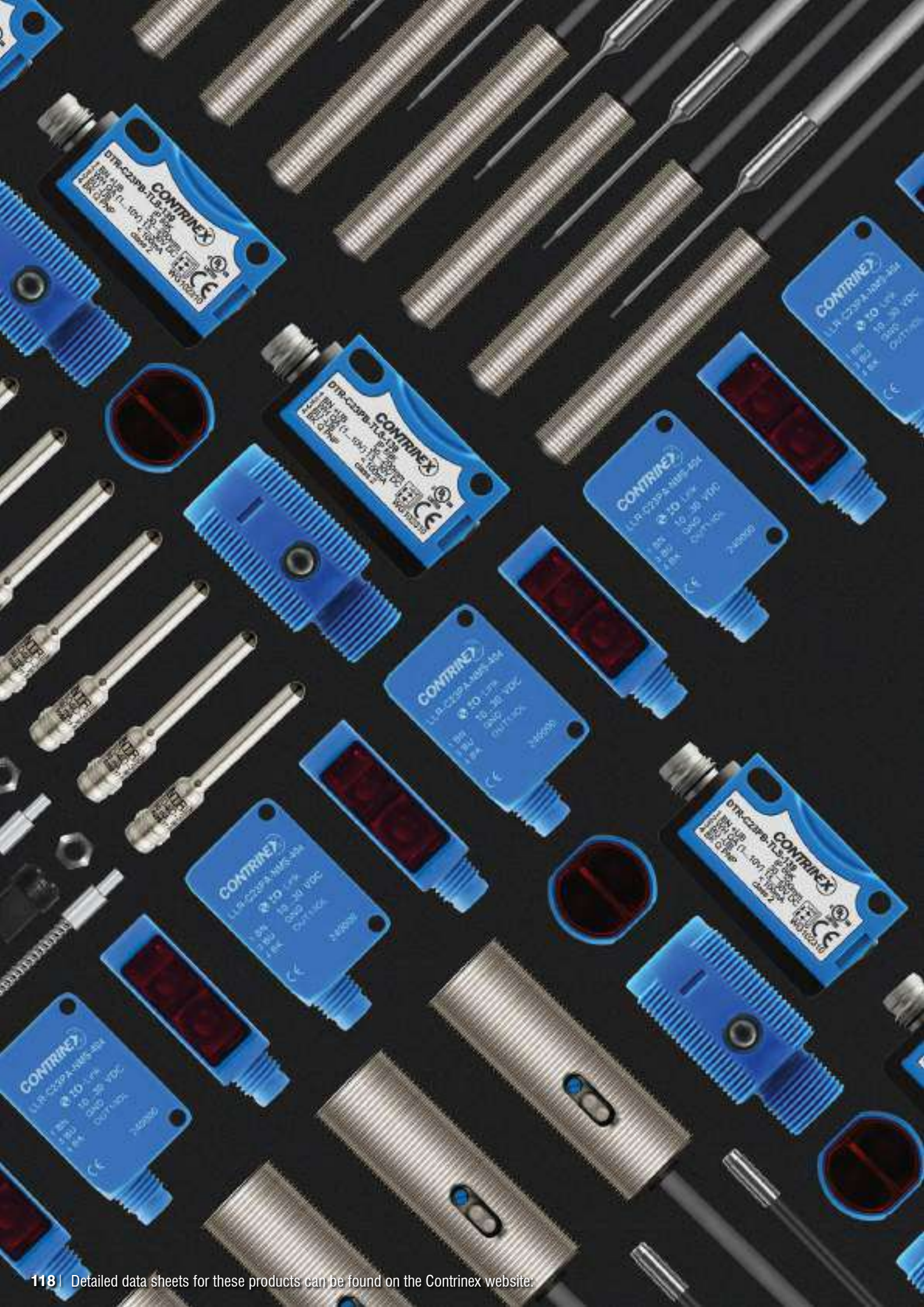

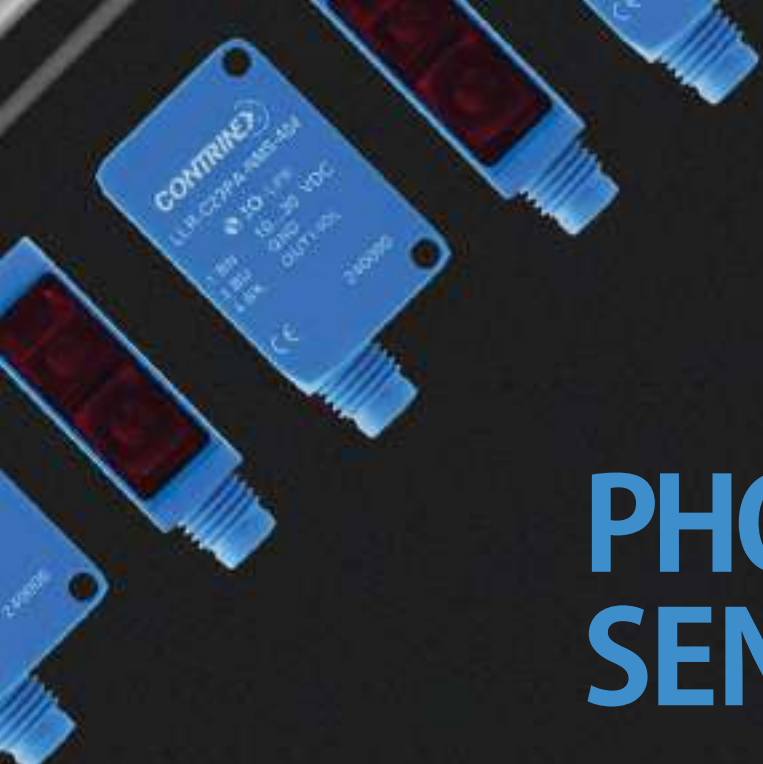





# PHOTOELECTRIC SENSORS

## HIGHLIGHTS

- ✓ Complete C23 series with first-class sensing ranges
- ✓ Excellent background suppression sensors
- ✓ Smallest self-contained miniature sensors on the market
- ✓ Wide range of fiber-optic amplifiers, including  IO-Link
- ✓ Excellent color and contrast recognition sensors

## NEW

- ✓ C23 sensors with patented UV technology for transparent object detection, including  IO-Link
- ✓ M18 series with short plastic housing and  IO-Link
- ✓ Distance measurement sensors in C23 and C55 size with  IO-Link
- ✓ Detection and measurement light grids
- ✓ Fork sensors with  IO-Link



# PHOTOELECTRIC SENSORS PROGRAM OVERVIEW

FAMILY	SERIES		D04	M05	M12M	1120	M18P	M18M	1180	
	HOUSING SIZE IN MM		∅ 4 IO-Link	M5 IO-Link	M12 IO-Link	M12	M18 IO-Link	M18 IO-Link	M18 IO-Link	
	OPERATING PRINCIPLE	SENSING RANGE	CYLINDRICAL							
STANDARD	Diffuse	0 ... 1,500 mm			IO-Link p. 126	p. 128	IO-Link p. 130	IO-Link p. 132	p. 134	
	Background suppression	2 ... 5,000 mm					IO-Link p. 130	IO-Link p. 132	p. 134	
	Reflex	0 ... 8,000 mm			IO-Link p. 126	p. 128	IO-Link p. 130	IO-Link p. 132	p. 134	
	Through-beam	0 ... 50,000 mm			IO-Link p. 126	p. 128	IO-Link p. 130	IO-Link p. 132	p. 136	
MINIATURE	Diffuse	0 ... 90 mm	IO-Link p. 150	IO-Link p. 150						
	Background suppression	2 ... 120 mm								
	Reflex	0 ... 3,000 mm								
	Through-beam	0 ... 2,000 mm	IO-Link p. 150	IO-Link p. 152						
TRANSPARENT OBJECT	Reflex, UV light	0 ... 1,200 mm								
	Reflex, red light	10 ... 5,000 mm								
FIBER OPTIC SENSORS AND FIBERS	Amplifier	0 ... 200 mm								
	Plastic fiber	0 ... 1,100 mm								
	Glass fiber	0 ... 500 mm								
DISTANCE	Short range	20 ... 200 mm								
	Medium range	0 ... 5,000 mm								
COLOR AND CONTRAST	Color	30 ... 40 mm								
	Contrast	12 mm								
LIGHT GRIDS	Detection	80 ... 8,000 mm								
	Measurement	300 ... 4,000 mm								
FORK	Through-beam	0 ... 120 mm								



	0507	C12	C23	3030	3060	4050	C55	DGI	MGI	LG
	5×7×40	13×21×7 13×27×7	20×30×10 20×34×12 IO-Link	30×30×15	31×60×10 IO-Link	40×50×15	50×50×23 IO-Link	40×20×H	40×20×H	60×10×GAP IO-Link
	CUBIC									U-SHAPE
			IO-Link p. 138	p. 142		p. 144				
			IO-Link p. 138	p. 142		p. 144	IO-Link p. 146			
			IO-Link p. 140	p. 142		p. 144				
			IO-Link p. 140	p. 142		p. 144				
	p. 154									
		p. 156								
		p. 156								
		p. 156								
			IO-Link p. 160							
			IO-Link p. 160							
				p. 164	IO-Link p. 166					
				p. 168	p. 166					
				p. 170						
			p. 178							
							p. 180			
						p. 184				
						IO-Link p. 184				
								p. 188		
									p. 190	
										IO-Link p. 194

# PHOTOELECTRIC SENSORS

## OPERATING PRINCIPLE

The light-emitting diode (LED) emits a beam of modulated light towards the target. This beam is interrupted by the target, causing partial reflection. A part of the reflected light reaches the sensing face of the receiver. Depending on the operating principle, either the interrupted beam or the reflected light is used for further processing.

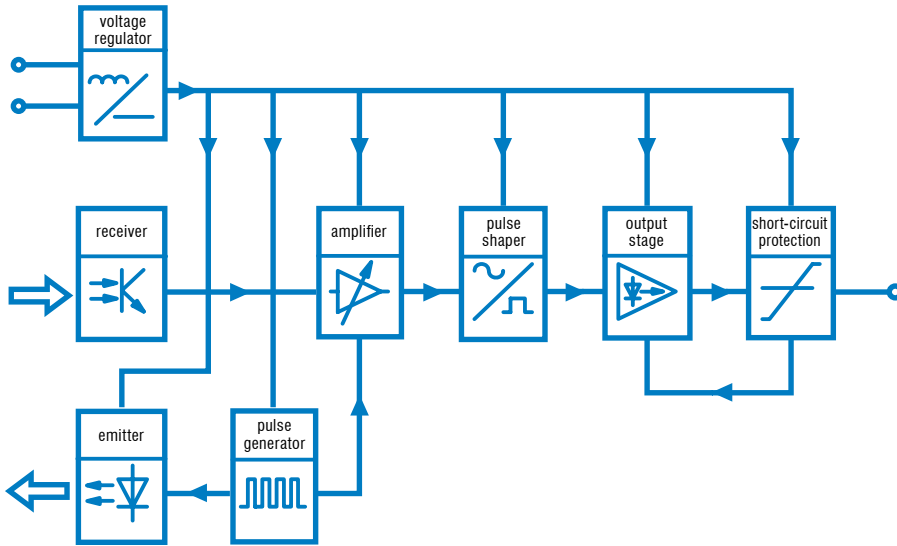
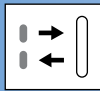

Fig. 8: Functional blocks of a photoelectric sensor

## TECHNOLOGY FAMILIES

### DIFFUSE



#### Versatile and cost-effective

A diffuse-mode, or energetic-diffuse, photoelectric sensor is a reflective sensor, containing a transmitter and a receiver in a single housing. The sensor emits a light beam toward a distant target that acts as a reflector, returning part of the transmitted light to the sensor. The receiver detects the amount of light reflected by the target, triggering the sensor when the light intensity reaches a threshold value.

Diffuse-mode sensors are cost-effective as they do not require separate reflectors or receivers, and detect reflective targets with ease. Sensing range depends on the target's size, shape, color

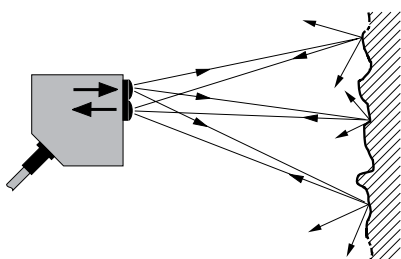
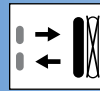

Fig. 9: Diffuse sensing

and surface finish, although sensor sensitivity is adjustable during installation to compensate for targets with poor reflective qualities.

### BACKGROUND SUPPRESSION



#### Excellent suppression of light-colored backgrounds

Diffuse-mode photoelectric sensors with background suppression emit a focused light beam toward a distant target. Part of the beam is reflected from the target and returns to the sensor, striking a position-sensitive receiver. The receiver distinguishes between reflections from the target and reflections from background objects, only triggering the sensor when the signal reaches a value that relates to the preset target distance.

The sensing range is practically insensitive to the target's size, color, shape and surface finish, and background-suppression sensors provide highly reliable detection of "difficult" targets, even against a light background. Stable, accurate detection of small, fast-moving parts on conveyors or automated machinery is possible over the entire sensing range, eliminating false triggering by objects in the background.

### REFLEX

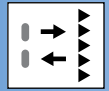

#### Long sensing range in a single-housing device

A reflex, or reflective, photoelectric sensor contains a transmitter and a receiver in a single housing, and emits a pulsed, focused light beam toward a distant reflector. Reflected light returns to the sensor, arriving at the receiver. When a target object interrupts the light beam, the receiver detects the reduced light intensity and triggers the sensor.

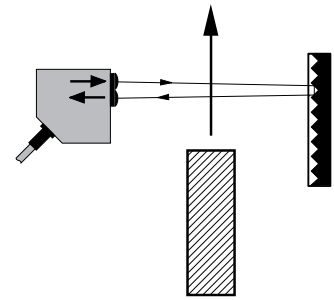
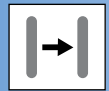

Fig. 10: Reflex sensing

The relatively high level of reflected light allows reflex sensors to achieve sensing distances up to eight meters.

### THROUGH-BEAM



#### Emitter and receiver in separate housings for sensing ranges from 0 to 50 m

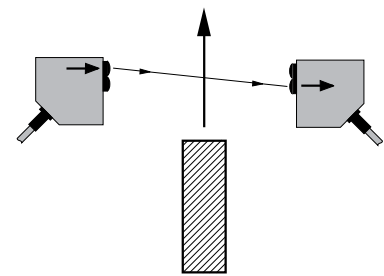

Fig. 11: Through-beam sensing

A through-beam photoelectric sensor comprises an emitter and receiver, each mounted in a separate housing. The emitter is aligned so that the greatest possible amount of pulsed light from its emitting diode reaches the receiver (Fig. 11). The receiver, which is mounted beyond the target area, processes incoming light in such a way that it is clearly separated from ambient and other light sources. Any interruption of the light beam by a target triggers the sensor, causing its output signal to switch.

Contrinex through-beam photoelectric sensors are ideal for industrial applications where sensing components must be mounted some distance from the target area. Through-beam sensors utilize infrared,

visible and laser light sources to detect opaque and semi-transparent targets, reliably and repeatably, at extended distances.

## ANALOG OUTPUT

### Precise distance control

Photoelectric sensors with analog outputs are ideal for measuring absolute values of distance. Using background suppression-mode technology, analog photoelectric sensors produce an output signal that is accurately calibrated and approximately proportional to the distance of the target from the sensor. Users have a choice of current or voltage outputs that are compatible with all modern control systems.



## TRANSPARENT OBJECT

Outstanding reliability and ease of adjustment environments

The Contrinex **TRU-C23** photoelectric sensor is ideally suited for the presence control of transparent objects. Its patented technology uses **UV light**. Since transparent materials like plastic or glass absorb large amounts of polarized UV light, it is very easy to set the threshold at which the sensor switches. The shape or thickness of the target has no influence on detection. In addition, sensor performance is unaffected by dirt, water drops or aging.



## COLOR AND CONTRAST

Excellent resolution for smallest variations

**Color** photoelectric sensors utilize energetic-diffuse sensing technology to detect variations in target color, allowing color sorting or color control. A "teach-in" function is used to program up to three separate outputs. Contrinex color photoelectric sensors also feature five selectable tolerance levels for each output.

**Contrast** sensors are ideal for detecting print marks in printing, labelling and packaging processes. Using a narrowly focused light beam and RGB emission technology, contrast sensors automatically select the best emission color (red, green or blue) during the teach-in procedure.

## PRODUCT RANGES



## STANDARD

First-class performance for general use



Contrinex **Standard** photoelectric sensors are ideal for general position- and presence-detection in almost any industry. With first-class sensing ranges and outstanding background suppression characteristics, the Standard range of sensors delivers very high accuracy and reliability. Light sources include infrared, laser and pinpoint LED.

include infrared, laser and pinpoint LED.



## FIBER-OPTIC SENSORS AND FIBERS

Reliable short and long-range sensing



The highly versatile **Fiber-Optic** range includes the self-contained **3030** series and the DIN-rail mounted **3060** series, suitable for multiple-sensor applications. **Synthetic fibers** are available for general use and **glass fibers** for high temperatures and aggressive environments.



## LIGHT GRIDS

Fast detection, counting and measurement



The use of infrared light grids for non-contact measurement offers many advantages, including fast response times, reliable detection of the most varied objects and immunity to interference from ambient light. Typical applications can be found in logistics, automated packaging systems, warehouses and the wood industry.



## MINIATURE

Smallest on the market



The Contrinex **Miniature** range packs exceptional position- and presence-sensing performance into the smallest self-contained photoelectric sensors on the market. Designers have the choice of through-beam or diffuse sensors in **Ø4** and **M5** cylindrical metal housings that offer multiple mounting methods and beam orientation. For fully embedded applications, sensors with spherical sapphire-glass lenses produce focused, cylindrical light beams.

For fully embedded applications, sensors with spherical sapphire-glass lenses produce focused, cylindrical light beams.



## DISTANCE

High precision and direct digital transmission



**DTR-C23** and **DTL-C23** sensors use a triangulation method for highly accurate distance measurement at short range. Types with red light (**DTR-C23**) measure distances **up to 200 mm**, while the measurement range for laser types (**DTL-C23**) is **up to 100 mm**. Applications include small-part detection, position or height checking and monitoring material thickness on winding rolls.



## FORK

Fast detection and counting in one housing



Fork sensors come either with an infrared or red LED with a detection frequency up to 14 kHz. They operate like a through beam sensor with the advantage of having the sensing and receiving element included in the same housing, thus reducing efforts on alignment and cable assembly. Fork sensors are particularly useful in packaging application to detect and count high speed objects or check the presence of a cap, hood or cover.



## APPLICATION

### Miniature photoelectric sensor detects fill level during secondary packaging operations

During secondary packaging of bags of confectionery, manufacturers arrange bags in overlapping layers. Multi-axis pick-and-place packing robots align and pack layers of bags in preformed cardboard cartons. The filled cartons are conveyed to case-sealing stations. A highly reliable photoelectric sensor, mounted directly above the conveyor, senses the height of the top layer of bags in each carton before sealing and rejects insufficiently filled cartons. Rugged photoelectric sensors with background suppression from the Contrinex C23 range are ideal for this application. A pinpoint red LED with a 10 mm-diameter light spot at the maximum sensing range of 300 mm ensures highly reliable detection of objects of almost any color against light or dark backgrounds. These sensors are well suited to both the task and the environment.

## INDUSTRIES

Automotive production and supply, machine tool, packaging, logistics, materials handling, food and beverage, textile



*Textile spinning machine automation*



*Beverage filling machines*



*Conveyor systems*



*Automotive part sensing*

# STANDARD

## PHOTOELECTRIC SENSORS

### FIRST-CLASS PERFORMANCE FOR GENERAL USE

Contrinex **Standard** photoelectric sensors are ideal for general position- and presence-detection in almost any industry. With first-class sensing ranges and outstanding background suppression characteristics, the Standard range of sensors delivers very high accuracy and reliability. Light sources include infrared, laser and pinpoint LED.

#### KEY ADVANTAGES

- ✓ First-class sensing ranges
- ✓ Outstanding background suppression characteristics
- ✓ C23 and M18P series: high quality ASIC sensors with an integral **IO-Link** interface in PNP types
- ✓ Light sources: red, infrared, laser and pinpoint LED

#### C23 Series

- ✓ Excellent background suppression characteristics with pinpoint LED
- ✓ Mutual interference immunity
- ✓ Versions available with stability alarm as second output
- ✓ Enclosure rating IP67, Ecolab approved

#### M18P Series

- ✓ Short housing: 37 mm with connector (cable types 33 mm)
- ✓ Excellent background suppression characteristics with pinpoint LED
- ✓ Mutual interference immunity
- ✓ Easy flush mounting
- ✓ Easy-to-mount special accessories for right-angle emission



#### PRODUCT OVERVIEW

**IO-Link**

SERIES	M12M	1120	M18P	M18M	1180	C23	3030	4050	C55	
Housing size mm	M12	M12	M18	M18	M18	□20×30×10	□30×30×15	□40×50×15	□50×50×23	
s <sub>n</sub> mm	Diffuse	800	300	1,200	1,200	250/600	1,500	600/1,200	1,200	–
	Reflex	4,000	1,500	7,000	7,000	2,000	8,000	2,000/4,000	4,000	–
	Through-beam	10,000	10,000/50,000	30,000	30,000	20,000/50,000	30,000	6,000/12,000	50,000	–
	Background suppression	–	–	250	250	120	300	200	500	5,000

#### ACCESSORIES

Go to page 298 to see all the accessories

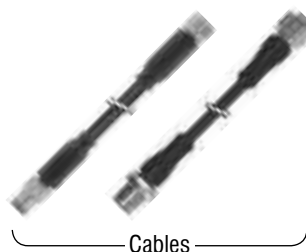

## COMMON FEATURES

**Supply Voltage range** 10 ... 30 VDC

## OUTPUT

Sensor type  
 [LL] Through-beam [LR] Reflex [LT] Diffuse  
 [xx][x]-M12MA-[xxx]-[xxx] — see p. 196  
 Emission type  
 [R] Red — see p. 196

Reference key on page 196

## OPERATING PRINCIPLE

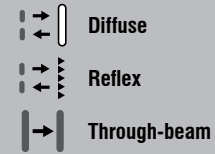

## ACCESSORIES

- A** Group A: M8 3-pin  
Sub-group: Field attachable connectors  
Sub-group: Distribution boxes
  - B** Group B: M8 4-pin  
Sub-group: Field attachable connectors
  - C** Group C: M12 4-pin  
Sub-group: Field attachable connectors  
Sub-group: Distribution boxes
  - D** Group D: M12 AC/DC 3-pin
  - E** Group E: Universal mounting brackets  
Sub-group: Mechanical stops
  - F** Group F: Photoelectric mounting brackets
  - G** Group G: Photoelectric reflectors
  - H** Group H: Sensor tester
- Go to page 298 for details

**CABLES**  
 Cable lengths available:  
 2 m, 5 m, 10 m  
 other customised lengths possible

# CYLINDRICAL M12 M12M SERIES

FAMILY	OPERATING PRINCIPLE	SENSING RANGE (mm)	HOUSING SIZE (mm)	LIGHT SOURCE
CYLINDRICAL M12 – M12M SERIES		800	M12	LED, red 645 nm
		800	M12	LED, red 645 nm
		800	M12	LED, red 645 nm
		800	M12	LED, red 645 nm
		4,000	M12	LED, red 645 nm
		4,000	M12	LED, red 645 nm
		4,000	M12	LED, red 645 nm
		4,000	M12	LED, red 645 nm
		10,000	M12	LED, red 630 nm
		10,000	M12	LED, red 630 nm
		10,000	M12	LED, red 630 nm
		10,000	M12	LED, red 630 nm
		10,000	M12	LED, red 630 nm
		10,000	M12	LED, red 630 nm
		10,000	M12	LED, red 630 nm



KEY ADVANTAGES

- ✓ M12 metal housing
- ✓ Sensitivity adjustment via potentiometer or IO-Link
- ✓ Focused RED light source
- ✓ Calibrated range
- ✓ Immune to mutual interference
- ✓ IO-Link v1.0



	HOUSING MATERIAL	CABLE	CONNECTOR	IO-Link	SWITCHING FREQUENCY (Hz)	AMBIENT TEMPERATURE	DEGREE OF PROTECTION	PART REFERENCE	ACCESSORIES (SEE PAGE 126)
	Chrome-plated brass		M12	IO-Link	1,500	-25 ... +65°C	IP67	LTR-M12MA-PMS-603	C E G H
	Chrome-plated brass		M12		1,500	-25 ... +65°C	IP67	LTR-M12MA-PMS-101	C E G H
	Chrome-plated brass			IO-Link	1,500	-25 ... +65°C	IP67	LTR-M12MA-PMK-603	E H
	Chrome-plated brass				1,500	-25 ... +65°C	IP67	LTR-M12MA-PMK-101	E H
	Chrome-plated brass		M12	IO-Link	1,500	-25 ... +65°C	IP67	LRR-M12MA-NMS-603	C E G H
	Chrome-plated brass		M12		1,500	-25 ... +65°C	IP67	LRR-M12MA-NMS-101	C E G H
	Chrome-plated brass			IO-Link	1,500	-25 ... +65°C	IP67	LRR-M12MA-NMK-603	E H
	Chrome-plated brass				1,500	-25 ... +65°C	IP67	LRR-M12MA-NMK-101	E H
	Chrome-plated brass		M12	IO-Link	1,000	-25 ... +65°C	IP67	LLR-M12MA-NMS-400	C E G H
	Chrome-plated brass			IO-Link	1,000	-25 ... +65°C	IP67	LLR-M12MA-NMK-400	E H
	Chrome-plated brass		M12	IO-Link	1,000	-25 ... +65°C	IP67	LLR-M12MA-NMS-603	C E G H
	Chrome-plated brass		M12		1,000	-25 ... +65°C	IP67	LLR-M12MA-NMS-101	C E G H
	Chrome-plated brass			IO-Link	1,000	-25 ... +65°C	IP67	LLR-M12MA-NMK-603	E H
	Chrome-plated brass				1,000	-25 ... +65°C	IP67	LLR-M12MA-NMK-101	E H

## COMMON FEATURES

Supply Voltage range	10 ... 30 VDC
Output	PNP Light-ON*

\* Other types available: PNP, NPN, Light-ON/Dark-ON

## OUTPUT

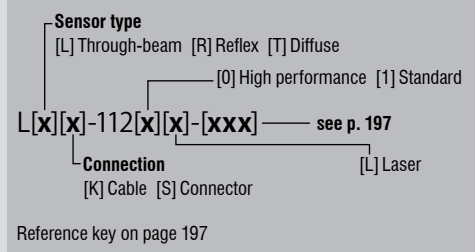

## OPERATING PRINCIPLE

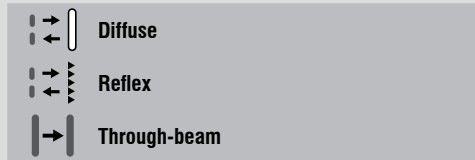

## ACCESSORIES

**A** Group A: M8 3-pin  
 Sub-group: Field attachable connectors  
 Sub-group: Distribution boxes

**B** Group B: M8 4-pin  
 Sub-group: Field attachable connectors

**C** Group C: M12 4-pin  
 Sub-group: Field attachable connectors  
 Sub-group: Distribution boxes

**D** Group D: M12 AC/DC 3-pin

**E** Group E: Universal mounting brackets  
 Sub-group: Mechanical stops

**F** Group F: Photoelectric mounting brackets

**G** Group G: Photoelectric reflectors

**H** Group H: Sensor tester

Go to page 298 for details

**CABLES**  
 Cable lengths available:  
 2 m, 5 m, 10 m  
 other customised lengths possible

# CYLINDRICAL M12 1120 SERIES

FAMILY	OPERATING PRINCIPLE	SENSING RANGE (mm)	HOUSING SIZE (mm)	LIGHT SOURCE
CYLINDRICAL M12 – 1120 SERIES		300	M12	LED, red 660 nm
		300	M12	LED, red 660 nm
		1,500	M12	LED, red 660 nm
		1,500	M12	LED, red 660 nm
		10,000	M12	LED, red 660 nm
		10,000	M12	LED, red 660 nm
		50,000	M12	⚠ Laser class 2, red 660 nm
		50,000	M12	⚠ Laser class 2, red 660 nm

CYLINDRICAL M12 – 1120 SERIES





**KEY ADVANTAGES**

- ✓ M12 sensor series
- ✓ Rugged metal housing
- ✓ Shock and vibration resistant due to fully potted electronics
- ✓ Laser types (protection class 2) for accurate detection of smallest targets
- ✓ Sensing range up to 50 m



	HOUSING MATERIAL	CABLE	CONNECTOR	IO-Link	SWITCHING FREQUENCY (Hz)	AMBIENT TEMPERATURE	DEGREE OF PROTECTION	PART REFERENCE*	ACCESSORIES (SEE PAGE 128)
	Chrome-plated brass				1,000	-25 ... +55°C	IP67	LTK-1120-303	E H
	Chrome-plated brass				1,000	-25 ... +55°C	IP67	LTS-1120-303	C E H
	Chrome-plated brass				1,000	-25 ... +55°C	IP67	LRK-1120-303	E G H
	Chrome-plated brass				1,000	-25 ... +55°C	IP67	LRS-1120-303	C E G H
	Chrome-plated brass				1,000	-25 ... +55°C	IP67	LLK-1120-203	E H
	Chrome-plated brass				1,000	-25 ... +55°C	IP67	LLS-1120-203	C E H
	Stainless steel V2A				5,000	-10 ... +50°C	IP67	LLK-1121L-203	E H
	Stainless steel V2A				5,000	-10 ... +50°C	IP67	LLS-1121L-203	C E H

## COMMON FEATURES

Supply Voltage range	10 ... 30 VDC
Output	PNP Light-ON*

\*Other types available: PNP NPN, Dark-ON, Light-ON/  
Dark-ON, Light-ON + stability alarm, Dark-ON + stability alarm

## OUTPUT





**Sensor type**  
 [LT] Diffuse [LR] Reflex [LL] Through-beam  
 [LH] Background suppression

**Housing material**  
 [M] Metal [P] Plastic

**Emission type**  
 [R] Red

**Reference key on page 196**  
 [xx][x]-M18[x]A-[xxx]-[xxx] — see p. 196

## OPERATING PRINCIPLE

 **Background suppression**  
 **Diffuse**  
 **Reflex**  
 **Through-beam**

## ACCESSORIES

**A Group A: M8 3-pin**  
 Sub-group: Field attachable connectors  
 Sub-group: Distribution boxes

**B Group B: M8 4-pin**  
 Sub-group: Field attachable connectors

**C Group C: M12 4-pin**  
 Sub-group: Field attachable connectors  
 Sub-group: Distribution boxes

**D Group D: M12 AC/DC 3-pin**

**E Group E: Universal mounting brackets**  
 Sub-group: Mechanical stops

**F Group F: Photoelectric mounting brackets**

























**G Group G: Photoelectric reflectors**

**H Group H: Sensor tester**

Go to page 298 for details

**CABLES**  
 Cable lengths available:  
 2 m, 5 m, 10 m  
 other customised lengths possible

# CYLINDRICAL M18 M18P/M18M SERIES

FAMILY	OPERATING PRINCIPLE	SENSING RANGE (mm)	HOUSING SIZE (mm)	LIGHT SOURCE
CYLINDRICAL M18 – M18P/M18M SERIES		250	M18	Pinpoint LED, red 640 nm
		250	M18	Pinpoint LED, red 640 nm
		250	M18	Pinpoint LED, red 640 nm
		250	M18	Pinpoint LED, red 640 nm
		250	M18	Pinpoint LED, red 640 nm
		250	M18	Pinpoint LED, red 640 nm
		250	M18	Pinpoint LED, red 640 nm
		250	M18	Pinpoint LED, red 640 nm
		250	M18	Pinpoint LED, red 640 nm
		250	M18	Pinpoint LED, red 640 nm
		250	M18	Pinpoint LED, red 640 nm
		250	M18	Pinpoint LED, red 640 nm
		250	M18	Pinpoint LED, red 640 nm
		1,200	M18	LED, red 630 nm
		1,200	M18	LED, red 630 nm
		1,200	M18	LED, red 630 nm
		1,200	M18	LED, red 630 nm
		1,200	M18	LED, red 630 nm
		1,200	M18	LED, red 630 nm
		1,200	M18	LED, red 630 nm
	1,200	M18	LED, red 630 nm	
	1,200	M18	LED, red 630 nm	
	7,000	M18	LED, red 630 nm	
	7,000	M18	LED, red 630 nm	
	30,000	M18	LED, red 630 nm	



KEY ADVANTAGES

- ✓ First-class sensing ranges
- ✓ Short housing: M18 × 33 mm (cable version), M18 × 37 mm (connector version)
- ✓ Excellent background suppression characteristics with pinpoint LED
- ✓ Mutual interference immunity
- ✓ IO-Link on all PNP sensors
- ✓ Easy flush mounting
- ✓ Easy-to-mount special accessories for right-angle emission

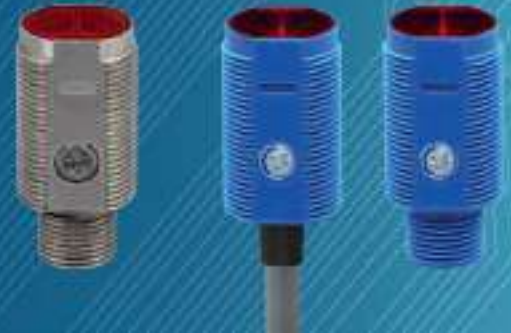

	HOUSING MATERIAL	CABLE	CONNECTOR	IO-Link	SWITCHING FREQUENCY (Hz)	AMBIENT TEMPERATURE	DEGREE OF PROTECTION	PART REFERENCE*	ACCESSORIES (SEE PAGE 130)
	ABS			IO-Link	700	-25 ... +65°C	IP67	LHR-M18PA-PMK-403	F H
	ABS			IO-Link	700	-25 ... +65°C	IP67	LHR-M18PA-PMK-603	F H
	ABS			IO-Link	700	-25 ... +65°C	IP67	LHR-M18PA-PMK-60C	F H
	ABS			IO-Link	700	-25 ... +65°C	IP67	LHR-M18PA-PMS-403	C F H
	ABS			IO-Link	700	-25 ... +65°C	IP67	LHR-M18PA-PMS-603	C F H
	ABS			IO-Link	700	-25 ... +65°C	IP67	LHR-M18PA-PMS-60C	C F H
	ABS			IO-Link	700	-25 ... +65°C	IP67	LHR-M18PA-TMK-403	F H
	ABS			IO-Link	700	-25 ... +65°C	IP67	LHR-M18PA-TMK-603	F H
	ABS			IO-Link	700	-25 ... +65°C	IP67	LHR-M18PA-TMK-60C	F H
	ABS			IO-Link	700	-25 ... +65°C	IP67	LHR-M18PA-TMS-403	C F H
	ABS			IO-Link	700	-25 ... +65°C	IP67	LHR-M18PA-TMS-603	C F H
	ABS			IO-Link	700	-25 ... +65°C	IP67	LHR-M18PA-TMS-60C	C F H
	ABS			IO-Link	1,500	-25 ... +65°C	IP67	LTR-M18PA-PMK-403	F H
	ABS			IO-Link	1,500	-25 ... +65°C	IP67	LTR-M18PA-PMK-603	F H
	ABS			IO-Link	1,500	-25 ... +65°C	IP67	LTR-M18PA-PMK-60C	F H
	ABS			IO-Link	1,500	-25 ... +65°C	IP67	LTR-M18PA-PMS-403	C F H
	ABS			IO-Link	1,500	-25 ... +65°C	IP67	LTR-M18PA-PMS-603	C F H
	ABS			IO-Link	1,500	-25 ... +65°C	IP67	LTR-M18PA-PMS-60C	C F H
	ABS			IO-Link	1,500	-25 ... +65°C	IP67	LTR-M18PA-NMK-403	F H
	ABS			IO-Link	1,500	-25 ... +65°C	IP67	LTR-M18PA-NMS-403	C F H
	ABS			IO-Link	1,500	-25 ... +65°C	IP67	LRR-M18PA-NMK-603	F G H
	ABS			IO-Link	1,500	-25 ... +65°C	IP67	LRR-M18PA-NMS-603	C F G H
	ABS			IO-Link	1,000	-25 ... +65°C	IP67	LLR-M18PA-NMK-400	F H

## COMMON FEATURES

Supply Voltage range	10 ... 30 VDC
Output	PNP Light-ON*

\*Other types available: PNP NPN, Dark-ON, Light-ON/  
Dark-ON, Light-ON + stability alarm, Dark-ON + stability alarm

## OUTPUT





**Sensor type**  
 [LT] Diffuse [LR] Reflex [LL] Through-beam  
 [LH] Background suppression

**Housing material**  
 [M] Metal [P] Plastic

**Emission type**  
 [R] Red

**Reference key on page 196**  
 [xx][x]-M18[x]A-[xxx]-[xxx] — see p. 196

## OPERATING PRINCIPLE

-  **Background suppression**
-  **Diffuse**
-  **Reflex**
-  **Through-beam**









## ACCESSORIES

- A** Group A: M8 3-pin  
Sub-group: Field attachable connectors  
Sub-group: Distribution boxes
- B** Group B: M8 4-pin  
Sub-group: Field attachable connectors
- C** Group C: M12 4-pin  
Sub-group: Field attachable connectors  
Sub-group: Distribution boxes
- D** Group D: M12 AC/DC 3-pin
- E** Group E: Universal mounting brackets  
Sub-group: Mechanical stops
- F** Group F: Photoelectric mounting brackets
- G** Group G: Photoelectric reflectors
- H** Group H: Sensor tester

Go to page 298 for details

**CABLES**  
Cable lengths available:  
2 m, 5 m, 10 m  
other customised lengths possible

# CYLINDRICAL M18 M18P/M18M SERIES

FAMILY	OPERATING PRINCIPLE	SENSING RANGE (mm)	HOUSING SIZE (mm)	LIGHT SOURCE
CYLINDRICAL M18 – M18P/M18M SERIES		30,000	M18	LED, red 630 nm
		30,000	M18	LED, red 630 nm
		30,000	M18	LED, red 630 nm
		250	M18	Pinpoint LED, red 640 nm
		250	M18	Pinpoint LED, red 640 nm
		1,200	M18	LED, red 630 nm
		7,000	M18	LED, red 630 nm
		30,000	M18	LED, red 630 nm
		30,000	M18	LED, red 630 nm

CYLINDRICAL M18 – M18P/M18M SERIES





**KEY ADVANTAGES**

- ✓ First-class sensing ranges
- ✓ Short housing: M18 × 33 mm (cable version), M18 × 37 mm (connector version)
- ✓ Excellent background suppression characteristics with pinpoint LED
- ✓ Mutual interference immunity
- ✓ IO-Link on all PNP sensors
- ✓ Easy flush mounting
- ✓ Easy-to-mount special accessories for right-angle emission



	HOUSING MATERIAL	CABLE	CONNECTOR	IO-Link	SWITCHING FREQUENCY (Hz)	AMBIENT TEMPERATURE	DEGREE OF PROTECTION	PART REFERENCE*	ACCESSORIES (SEE PAGE 132)
	ABS		M12	IO-Link	1,000	−25 ... +65°C	IP67	<b>LLR-M18PA-NMS-400</b>	<b>C F H</b>
	ABS			IO-Link	1,000	−25 ... +65°C	IP67	<b>LLR-M18PA-NMK-603</b>	<b>F H</b>
	ABS		M12	IO-Link	1,000	−25 ... +65°C	IP67	<b>LLR-M18PA-NMS-603</b>	<b>C F H</b>
	Stainless steel		M12	IO-Link	700	−25 ... +65°C	IP67	<b>LHR-M18MA-PMS-603</b>	<b>C F H</b>
	Stainless steel		M12	IO-Link	700	−25 ... +65°C	IP67	<b>LHR-M18MA-TMS-603</b>	<b>C F H</b>
	Stainless steel		M12	IO-Link	1,500	−25 ... +65°C	IP67	<b>LTR-M18MA-PMS-603</b>	<b>C F H</b>
	Stainless steel		M12	IO-Link	1,500	−25 ... +65°C	IP67	<b>LRR-M18MA-NMS-603</b>	<b>C F G H</b>
	Stainless steel		M12	IO-Link	1,000	−25 ... +65°C	IP67	<b>LLR-M18MA-NMS-400</b>	<b>C F H</b>
	Stainless steel		M12	IO-Link	1,000	−25 ... +65°C	IP67	<b>LLR-M18MA-NMS-603</b>	<b>C F H</b>

## COMMON FEATURES

Supply Voltage range	10 ... 30 VDC
Output	PNP Light-ON*

\* Other types available: PNP, NPN, Light-ON/Dark-ON

## OUTPUT

**Sensor type**  
 [H] Background suppression [L] Through-beam  
 [R] Reflex [T] Diffuse

[0] High performance [L] Laser  
 [1] Standard [W] Face 90°

L[X][X]-118[X][X]-[XXX]-[XXX] — see p. 197

**Connection**  
 [K] Cable [S] Connector — see p. 197

Reference key on page 197

## OPERATING PRINCIPLE

- Background suppression
- Diffuse
- Reflex
- Through-beam

## ACCESSORIES

- A** Group A: M8 3-pin  
Sub-group: Field attachable connectors  
Sub-group: Distribution boxes
- B** Group B: M8 4-pin  
Sub-group: Field attachable connectors
- C** Group C: M12 4-pin  
Sub-group: Field attachable connectors  
Sub-group: Distribution boxes
- D** Group D: M12 AC/DC 3-pin
- E** Group E: Universal mounting brackets  
Sub-group: Mechanical stops
- F** Group F: Photoelectric mounting brackets
- G** Group G: Photoelectric reflectors
- H** Group H: Sensor tester

Go to page 298 for details

**CABLES**  
 Cable lengths available:  
 2 m, 5 m, 10 m  
 other customised lengths possible

# CYLINDRICAL M18 1180 SERIES

FAMILY	OPERATING PRINCIPLE	SENSING RANGE (mm)	HOUSING SIZE (mm)	LIGHT SOURCE
CYLINDRICAL M18 – 1180 SERIES		120	M18	LED, red 660 nm
		120	M18	LED, red 660 nm
		120	M18	LED, red 660 nm
		120	M18	LED, red 660 nm
		120	M18	LED, red 660 nm
		250	M18	⚠ Laser class 2, red 660 nm
		250	M18	⚠ Laser class 2, red 660 nm
		250	M18	⚠ Laser class 2, red 660 nm
		250	M18	⚠ Laser class 2, red 660 nm
		600	M18	LED, red 660 nm
		600	M18	LED, red 660 nm
		600	M18	LED, red 660 nm
		600	M18	LED, red 660 nm
		600	M18	LED, red 660 nm
		600	M18	LED, red 660 nm
		600	M18	LED, red 660 nm
		600	M18	LED, red 660 nm
		600	M18	⚠ Laser class 2, red 660 nm
		600	M18	⚠ Laser class 2, red 660 nm
		600	M18	⚠ Laser class 2, red 660 nm
	600	M18	⚠ Laser class 2, red 660 nm	
	2,000	M18	LED, red 660 nm	
	2,000	M18	LED, red 660 nm	



KEY ADVANTAGES

- ✓ Models for lateral sensing
- ✓ Rugged metal housing
- ✓ Shock & vibration resistant due to fully potted electronics
- ✓ Laser types (protection class 2) for accurate detection of smallest targets
- ✓ Sensing range up to 50 m



	HOUSING MATERIAL	CABLE	CONNECTOR	IO-Link	SWITCHING FREQUENCY (Hz)	AMBIENT TEMPERATURE	DEGREE OF PROTECTION	PART REFERENCE*	ACCESSORIES (SEE PAGE 134)
	Chrome-plated brass				500	-25 ... +55°C	IP67	LHK-1180-303	
	Chrome-plated brass				500	-25 ... +55°C	IP67	LHS-1180-303	
	Chrome-plated brass				500	-25 ... +55°C	IP67	LHK-1180W-303	
	Chrome-plated brass				500	-25 ... +55°C	IP67	LHS-1180W-303	
	Stainless steel V2A				5,000	-10 ... +50°C	IP67	LTK-1180L-103-516	
	Stainless steel V2A				5,000	-10 ... +50°C	IP67	LTK-1180L-104-516	
	Stainless steel V2A				5,000	-10 ... +50°C	IP67	LTS-1180L-103-516	
	Stainless steel V2A				5,000	-10 ... +50°C	IP67	LTS-1180L-104-516	
	Chrome-plated brass				1,000	-25 ... +55°C	IP67	LTS-1180W-303	
	Chrome-plated brass				1,000	-25 ... +55°C	IP67	LTK-1180-103	
	Chrome-plated brass				1,000	-25 ... +55°C	IP67	LTK-1180-104	
	Chrome-plated brass				1,000	-25 ... +55°C	IP67	LTS-1180-103	
	Chrome-plated brass				1,000	-25 ... +55°C	IP67	LTS-1180-104	
	Chrome-plated brass				1,000	-25 ... +55°C	IP67	LTK-1180W-103	
	Chrome-plated brass				1,000	-25 ... +55°C	IP67	LTK-1180W-104	
	Chrome-plated brass				1,000	-25 ... +55°C	IP67	LTS-1180W-103	
	Chrome-plated brass				1,000	-25 ... +55°C	IP67	LTS-1180W-104	
	Stainless steel V2A				1,000	-10 ... +50°C	IP67	LTK-1180L-103	
	Stainless steel V2A				1,000	-10 ... +50°C	IP67	LTK-1180L-104	
	Stainless steel V2A				1,000	-10 ... +50°C	IP67	LTS-1180L-103	
	Stainless steel V2A				1,000	-10 ... +50°C	IP67	LTS-1180L-104	
	Chrome-plated brass				1,000	-25 ... +55°C	IP67	LTK-1180-303	
	Chrome-plated brass				1,000	-25 ... +55°C	IP67	LRS-1180-303	

## COMMON FEATURES

Supply Voltage range	10 ... 30 VDC
Output	PNP Light-ON*

\* Other types available: PNP, NPN, Light-ON/Dark-ON

## OUTPUT

**Sensor type**  
 [H] Background suppression [L] Through-beam  
 [R] Reflex [T] Diffuse

[0] High performance [L] Laser  
 [1] Standard [W] Face 90°

L[X][X]-118[X][X]-[XXX]-[XXX] — see p. 197

**Connection**  
 [K] Cable [S] Connector — see p. 197

Reference key on page 197

## OPERATING PRINCIPLE

- Background suppression
- Diffuse
- Reflex
- Through-beam

## ACCESSORIES

- A** Group A: M8 3-pin  
Sub-group: Field attachable connectors  
Sub-group: Distribution boxes
- B** Group B: M8 4-pin  
Sub-group: Field attachable connectors
- C** Group C: M12 4-pin  
Sub-group: Field attachable connectors  
Sub-group: Distribution boxes
- D** Group D: M12 AC/DC 3-pin
- E** Group E: Universal mounting brackets  
Sub-group: Mechanical stops
- F** Group F: Photoelectric mounting brackets
- G** Group G: Photoelectric reflectors
- H** Group H: Sensor tester

Go to page 298 for details

**CABLES**  
 Cable lengths available:  
 2 m, 5 m, 10 m  
 other customised lengths possible

# CYLINDRICAL M18 1180 SERIES

FAMILY	OPERATING PRINCIPLE	SENSING RANGE (mm)	HOUSING SIZE (mm)	LIGHT SOURCE
CYLINDRICAL M18 – 1180 SERIES		2,000	M18	LED, red 660 nm
		2,000	M18	LED, red 660 nm
		20,000	M18	LED, red 660 nm
		20,000	M18	LED, red 660 nm
		20,000	M18	LED, red 660 nm
		20,000	M18	LED, red 660 nm
		20,000	M18	LED, red 660 nm
		20,000	M18	LED, red 660 nm
		20,000	M18	LED, red 660 nm
		20,000	M18	LED, red 660 nm
		20,000	M18	LED, red 660 nm
		20,000	M18	LED, red 660 nm
		50,000	M18	⚠ Laser class 2, red 660 nm
		50,000	M18	⚠ Laser class 2, red 660 nm



**KEY ADVANTAGES**

- ✓ Models for lateral sensing
- ✓ Rugged metal housing
- ✓ Shock & vibration resistant due to fully potted electronics
- ✓ Laser types (protection class 2) for accurate detection of smallest targets
- ✓ Sensing range up to 50 m



	HOUSING MATERIAL	CABLE	CONNECTOR	IO-Link	SWITCHING FREQUENCY (Hz)	AMBIENT TEMPERATURE	DEGREE OF PROTECTION	PART REFERENCE*	ACCESSORIES (SEE PAGE 136)
	Chrome-plated brass				1,000	-25 ... +55°C	IP67	<b>LRK-1180W-303</b>	<b>E G H</b>
	Chrome-plated brass				1,000	-25 ... +55°C	IP67	<b>LRS-1180W-303</b>	<b>C E G H</b>
	Chrome-plated brass				1,000	-25 ... +55°C	IP67	<b>LLK-1180W-003</b>	<b>E H</b>
	Chrome-plated brass				1,000	-25 ... +55°C	IP67	<b>LLK-1180W-004</b>	<b>E H</b>
	Chrome-plated brass				1,000	-25 ... +55°C	IP67	<b>LLS-1180W-003</b>	<b>C E H</b>
	Chrome-plated brass				1,000	-25 ... +55°C	IP67	<b>LLS-1180W-004</b>	<b>C E H</b>
	Chrome-plated brass				1,000	-25 ... +55°C	IP67	<b>LLK-1180-003</b>	<b>E H</b>
	Chrome-plated brass				1,000	-25 ... +55°C	IP67	<b>LLK-1180-004</b>	<b>E H</b>
	Chrome-plated brass				1,000	-25 ... +55°C	IP67	<b>LLS-1180-003</b>	<b>C E H</b>
	Chrome-plated brass				1,000	-25 ... +55°C	IP67	<b>LLS-1180-004</b>	<b>C E H</b>
	Stainless steel V2A				5,000	-10 ... +50°C	IP67	<b>LLK-1181L-003</b>	<b>E H</b>
	Stainless steel V2A				5,000	-10 ... +50°C	IP67	<b>LLS-1181L-003</b>	<b>C E H</b>

## COMMON FEATURES

Supply Voltage range	10 ... 30 VDC
Output	PNP Light-ON*

\*Other types available: PNP NPN, Dark-ON, Light-ON/  
Dark-ON, Light-ON + stability alarm, Dark-ON + stability alarm  
\*\* Pigtail versions available

## OUTPUT

**Sensor type**  
[LH] Background suppression [LL] Through-beam  
[LR] Reflex [LT] Diffuse

**Emission type**  
[R] Red

**Reference key on page 196**

**Example:** [xx][x]-C23PA-[xxx]-[xxx] — see p. 196

## OPERATING PRINCIPLE

- Background suppression
- Diffuse
- Reflex
- Through-beam

## ACCESSORIES

- A Group A: M8 3-pin**  
Sub-group: Field attachable connectors  
Sub-group: Distribution boxes
- B Group B: M8 4-pin**  
Sub-group: Field attachable connectors
- C Group C: M12 4-pin**  
Sub-group: Field attachable connectors  
Sub-group: Distribution boxes
- D Group D: M12 AC/DC 3-pin**
- E Group E: Universal mounting brackets**  
Sub-group: Mechanical stops
- F Group F: Photoelectric mounting brackets**
- G Group G: Photoelectric reflectors**
- H Group H: Sensor tester**

Go to page 298 for details

**CABLES**  
Cable lengths available:  
2 m, 5 m, 10 m  
other customised lengths possible

# CUBIC C23 C23 SERIES

FAMILY	OPERATING PRINCIPLE	SENSING RANGE (mm)	HOUSING SIZE (mm)	LIGHT SOURCE
CUBIC C23 – C23 SERIES		300	20 × 30 (C23)	Pinpoint LED, red 640 nm
		300	20 × 30 (C23)	Pinpoint LED, red 640 nm
		300	20 × 30 (C23)	Pinpoint LED, red 640 nm
		300	20 × 30 (C23)	Pinpoint LED, red 640 nm
		300	20 × 30 (C23)	Pinpoint LED, red 640 nm
		300	20 × 30 (C23)	Pinpoint LED, red 640 nm
		300	20 × 30 (C23)	Pinpoint LED, red 640 nm
		300	20 × 30 (C23)	Pinpoint LED, red 640 nm
		300	20 × 30 (C23)	Pinpoint LED, red 640 nm
		300	20 × 30 (C23)	Pinpoint LED, red 640 nm
		300	20 × 30 (C23)	Pinpoint LED, red 640 nm
		300	20 × 30 (C23)	Pinpoint LED, red 640 nm
		300	20 × 30 (C23)	Pinpoint LED, red 640 nm
		300	20 × 30 (C23)	Pinpoint LED, red 640 nm
		300	20 × 30 (C23)	Pinpoint LED, red 640 nm
		300	20 × 30 (C23)	Pinpoint LED, red 640 nm
		1,500	20 × 30 (C23)	LED, red 630 nm
		1,500	20 × 30 (C23)	LED, red 630 nm
		1,500	20 × 30 (C23)	LED, red 630 nm
		1,500	20 × 30 (C23)	LED, red 630 nm
	1,500	20 × 30 (C23)	LED, red 630 nm	
	1,500	20 × 30 (C23)	LED, red 630 nm	
	1,500	20 × 30 (C23)	LED, red 630 nm	
	1,500	20 × 30 (C23)	LED, red 630 nm	



KEY ADVANTAGES

- ✓ First-class sensing ranges
- ✓ Small plastic housing, 20 × 30 × 10 mm
- ✓ Excellent background suppression characteristics with pinpoint LED
- ✓ IO-Link interface available on PNP types
- ✓ Mutual interference immunity
- ✓ Versions available with stability alarm as second output
- ✓ Enclosure rating IP67, Ecolab approved
- ✓ Versatile mounting brackets for ease of installation



	HOUSING MATERIAL	CABLE**	CONNECTOR**	IO-Link	SWITCHING FREQUENCY (Hz)	AMBIENT TEMPERATURE	DEGREE OF PROTECTION	PART REFERENCE *	ACCESSORIES (SEE PAGE 138)
	ABS			IO-Link	1,000	-25 ... +65°C	IP67	LHR-C23PA-PMK-403	F H
	ABS			IO-Link	1,000	-25 ... +65°C	IP67	LHR-C23PA-PMK-603	F H
	ABS			IO-Link	1,000	-25 ... +65°C	IP67	LHR-C23PA-PMK-60C	F H
	ABS			IO-Link	1,000	-25 ... +65°C	IP67	LHR-C23PA-PMS-403	A F H
	ABS			IO-Link	1,000	-25 ... +65°C	IP67	LHR-C23PA-PMS-603	B F H
	ABS			IO-Link	1,000	-25 ... +65°C	IP67	LHR-C23PA-PMS-60C	B F H
	ABS			IO-Link	1,000	-25 ... +65°C	IP67	LHR-C23PA-TMK-403	F H
	ABS			IO-Link	1,000	-25 ... +65°C	IP67	LHR-C23PA-TMK-603	F H
	ABS			IO-Link	1,000	-25 ... +65°C	IP67	LHR-C23PA-TMK-60C	F H
	ABS			IO-Link	1,000	-25 ... +65°C	IP67	LHR-C23PA-TMS-403	A F H
	ABS			IO-Link	1,000	-25 ... +65°C	IP67	LHR-C23PA-TMS-603	B F H
	ABS			IO-Link	1,000	-25 ... +65°C	IP67	LHR-C23PA-TMS-60C	B F H
	ABS			IO-Link	1,000	-25 ... +65°C	IP67	LHR-C23PA-PMV-603-324	C F H
	ABS			IO-Link	1,000	-25 ... +65°C	IP67	LHR-C23PA-TMV-603-324	C F H
	ABS			IO-Link	1,000	-25 ... +65°C	IP67	LHR-C23PA-PMV-403-326	A F H
	ABS			IO-Link	1,000	-25 ... +65°C	IP67	LHR-C23PA-TMV-403-326	A F H
	ABS			IO-Link	1,500	-25 ... +65°C	IP67	LTR-C23PA-PMK-403	F H
	ABS			IO-Link	1,500	-25 ... +65°C	IP67	LTR-C23PA-PMK-603	F H
	ABS			IO-Link	1,500	-25 ... +65°C	IP67	LTR-C23PA-PMK-60C	F H
	ABS			IO-Link	1,500	-25 ... +65°C	IP67	LTR-C23PA-PMS-403	A F H
	ABS			IO-Link	1,500	-25 ... +65°C	IP67	LTR-C23PA-PMS-603	B F H
	ABS			IO-Link	1,500	-25 ... +65°C	IP67	LTR-C23PA-PMS-60C	B F H
	ABS			IO-Link	1,500	-25 ... +65°C	IP67	LTR-C23PA-NMK-403	F H

## COMMON FEATURES

Supply Voltage range	10 ... 30 VDC
Output	PNP Light-ON*

\* Other types available: PNP NPN, Dark-ON, Light-ON/  
Dark-ON, Light-ON + stability alarm, Dark-ON + stability alarm  
\*\* Pigtail versions available

## OUTPUT





**Sensor type**  
[LH] Background suppression [LL] Through-beam  
[LR] Reflex [LT] Diffuse

**[xx][x]-C23PA-[xxx]-[xxx]** — see p. 196

**Emission type** — see p. 196  
[R] Red

Reference key on page 196

## OPERATING PRINCIPLE

-  Background suppression
-  Diffuse
-  Reflex
-  Through-beam















## ACCESSORIES

- A** Group A: M8 3-pin  
Sub-group: Field attachable connectors  
Sub-group: Distribution boxes
- B** Group B: M8 4-pin  
Sub-group: Field attachable connectors
- C** Group C: M12 4-pin  
Sub-group: Field attachable connectors  
Sub-group: Distribution boxes
- D** Group D: M12 AC/DC 3-pin
- E** Group E: Universal mounting brackets  
Sub-group: Mechanical stops
- F** Group F: Photoelectric mounting brackets
- G** Group G: Photoelectric reflectors
- H** Group H: Sensor tester

Go to page 298 for details

**CABLES**  
Cable lengths available:  
2 m, 5 m, 10 m  
other customised lengths possible

# CUBIC C23 C23 SERIES

FAMILY	OPERATING PRINCIPLE	SENSING RANGE (mm)	HOUSING SIZE (mm)	LIGHT SOURCE
CUBIC C23 – C23 SERIES		1,500	20 × 30 (C23)	LED, red 630 nm
		1,500	20 × 30 (C23)	LED, red 630 nm
		1,500	20 × 30 (C23)	LED, red 630 nm
		8,000	20 × 30 (C23)	LED, red 630 nm
		8,000	20 × 30 (C23)	LED, red 630 nm
		8,000	20 × 30 (C23)	LED, red 630 nm
		30,000	20 × 30 (C23)	LED, red 630 nm
		30,000	20 × 30 (C23)	LED, red 630 nm
		30,000	20 × 30 (C23)	LED, red 630 nm
		30,000	20 × 30 (C23)	LED, red 630 nm
		30,000	20 × 30 (C23)	LED, red 630 nm
		30,000	20 × 30 (C23)	LED, red 630 nm
		30,000	20 × 30 (C23)	LED, red 630 nm
		30,000	20 × 30 (C23)	LED, red 630 nm



KEY ADVANTAGES

- ✓ First-class sensing ranges
- ✓ Small plastic housing, 20 × 30 × 10 mm
- ✓ Excellent background suppression characteristics with pinpoint LED
- ✓ IO-Link interface available on PNP types
- ✓ Mutual interference immunity
- ✓ Versions available with stability alarm as second output
- ✓ Enclosure rating IP67, Ecolab approved
- ✓ Versatile mounting brackets for ease of installation



	HOUSING MATERIAL	CABLE**	CONNECTOR**	IO-Link	SWITCHING FREQUENCY (Hz)	AMBIENT TEMPERATURE	DEGREE OF PROTECTION	PART REFERENCE *	ACCESSORIES (SEE PAGE 140)
	ABS		M8	IO-Link	1,500	−25 ... +65°C	IP67	LTR-C23PA-NMS-403	
	ABS	0.2 m PVC	M12	IO-Link	1,500	−25 ... +65°C	IP67	LTR-C23PA-PMV-603-324	
	ABS	0.2 m PUR	M8	IO-Link	1,500	−25 ... +65°C	IP67	LTR-C23PA-PMV-403-326	
	ABS	PVC		IO-Link	1,500	−25 ... +65°C	IP67	LRR-C23PA-NMK-603	
	ABS		M8	IO-Link	1,500	−25 ... +65°C	IP67	LRR-C23PA-NMS-603	
	ABS	0.2 m PVC	M12	IO-Link	1,500	−25 ... +65°C	IP67	LRR-C23PA-NMV-603-324	
	ABS	PVC		IO-Link	1,000	−25 ... +65°C	IP67	LLR-C23PA-NMK-400	
	ABS		M8	IO-Link	1,000	−25 ... +65°C	IP67	LLR-C23PA-NMS-400	
	ABS	PVC		IO-Link	1,000	−25 ... +65°C	IP67	LLR-C23PA-NMK-603	
	ABS		M8	IO-Link	1,000	−25 ... +65°C	IP67	LLR-C23PA-NMS-603	
	ABS	0.2 m PVC	M12	IO-Link	1,000	−25 ... +65°C	IP67	LLR-C23PA-NMV-400-324	
	ABS	0.2 m PVC	M12	IO-Link	1,000	−25 ... +65°C	IP67	LLR-C23PA-NMV-603-324	

# PHOTOELECTRIC SENSORS STANDARD

## COMMON FEATURES

Supply Voltage range	10 ... 30 VDC
Output	PNP Light-ON*

\* Other types available: PNP, NPN, Light-ON/Dark-ON

## OUTPUT





**Sensor type**  
 [H] Background suppression [L] Through-beam  
 [R] Reflex [T] Diffuse

L[x][x]-303[x]-[xxx] — see p. 197

**Connection**  
 [K] Cable [S] Connector [0] High performance  
 [1] Standard

Reference key on page 197

## OPERATING PRINCIPLE

-  **Background suppression**
-  **Diffuse**
-  **Reflex**
-  **Through-beam**















## ACCESSORIES

-  **A Group A: M8 3-pin**  
 Sub-group: Field attachable connectors  
 Sub-group: Distribution boxes
-  **B Group B: M8 4-pin**  
 Sub-group: Field attachable connectors
-  **C Group C: M12 4-pin**  
 Sub-group: Field attachable connectors  
 Sub-group: Distribution boxes
-  **D Group D: M12 AC/DC 3-pin**
-  **E Group E: Universal mounting brackets**  
 Sub-group: Mechanical stops
-  **F Group F: Photoelectric mounting brackets**
-  **G Group G: Photoelectric reflectors**
-  **H Group H: Sensor tester**

Go to page 298 for details

 **CABLES**  
 Cable lengths available:  
 2 m, 5 m, 10 m  
 other customised lengths possible

# CUBIC 3030 3030 SERIES

FAMILY	OPERATING PRINCIPLE	SENSING RANGE (mm)	HOUSING SIZE (mm)	LIGHT SOURCE
CUBIC 3030 – 3030 SERIES		150	30 × 30	LED, red 660 nm
		150	30 × 30	LED, red 660 nm
		600	30 × 30	LED, infrared 880 nm
		600	30 × 30	LED, infrared 880 nm
		1,200	30 × 30	LED, infrared 880 nm
		1,200	30 × 30	LED, infrared 880 nm
		2,000	30 × 30	LED, red 660 nm
		2,000	30 × 30	LED, red 660 nm
		4,000	30 × 30	LED, red 660 nm
		4,000	30 × 30	LED, red 660 nm
		4,000	30 × 30	LED, red 660 nm
		6,000	30 × 30	LED, infrared 880 nm
		6,000	30 × 30	LED, infrared 880 nm
		12,000	30 × 30	LED, infrared 880 nm



**KEY ADVANTAGES**

- ✓ Complete miniature sensor series 30 × 30 × 15 mm in rugged Crastin housings
- ✓ Sensing range up to 12,000 mm for through-beam type
- ✓ Shock & vibration resistant due to fully potted electronics
- ✓ Diffuse sensors with precise background suppression
- ✓ Polarizing filter (reflex sensors)
- ✓ High system reserves (excess gain)
- ✓ Pre-failure warning (pollution monitoring)
- ✓ Changeover outputs



	HOUSING MATERIAL	CABLE	CONNECTOR	IO-Link	SWITCHING FREQUENCY (Hz)	AMBIENT TEMPERATURE	DEGREE OF PROTECTION	PART REFERENCE*	ACCESSORIES (SEE PAGE 142)
	PBTP (Crastin)	PVC			500	-25 ... +55°C	IP67	LHK-3031-303	F H
	PBTP (Crastin)		M8		500	-25 ... +55°C	IP67	LHS-3031-303	A F H
	PBTP (Crastin)	PVC			1,000	-25 ... +55°C	IP67	LTK-3031-303	F H
	PBTP (Crastin)		M8		1,000	-25 ... +55°C	IP67	LTS-3031-303	A F H
	PBTP (Crastin)	PVC			1,000	-25 ... +55°C	IP67	LTK-3030-103	F H
	PBTP (Crastin)		M8		1,000	-25 ... +55°C	IP67	LTS-3030-103	B F H
	PBTP (Crastin)	PVC			1,000	-25 ... +55°C	IP67	LRK-3031-303	F G H
	PBTP (Crastin)		M8		1,000	-25 ... +55°C	IP67	LRS-3031-303	A F G H
	PBTP (Crastin)	PVC			1,000	-25 ... +55°C	IP67	LRK-3030-103	F G H
	PBTP (Crastin)		M8		1,000	-25 ... +55°C	IP67	LRS-3030-103	B F G H
	PBTP (Crastin)		M8		1,000	-25 ... +55°C	IP67	LRS-3030-104	B F G H
	PBTP (Crastin)	PVC			1,000	-25 ... +55°C	IP67	LLK-3031-203	F H
	PBTP (Crastin)		M8		1,000	-25 ... +55°C	IP67	LLS-3031-203	A F H
	PBTP (Crastin)		M8		1,000	-25 ... +55°C	IP67	LLS-3030-003	B F H

# PHOTOELECTRIC SENSORS STANDARD

## COMMON FEATURES

**Supply Voltage range** 10 ... 30 VDC

## OUTPUT

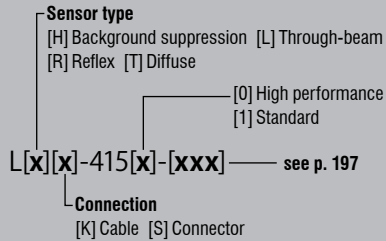

Reference key on page 197

## OPERATING PRINCIPLE

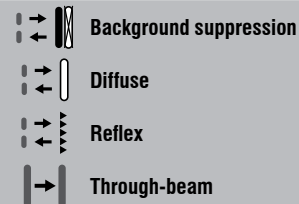

## ACCESSORIES

- A** Group A: M8 3-pin  
Sub-group: Field attachable connectors  
Sub-group: Distribution boxes
- B** Group B: M8 4-pin  
Sub-group: Field attachable connectors
- C** Group C: M12 4-pin  
Sub-group: Field attachable connectors  
Sub-group: Distribution boxes
- D** Group D: M12 AC/DC 3-pin
- E** Group E: Universal mounting brackets  
Sub-group: Mechanical stops
- F** Group F: Photoelectric mounting brackets
- G** Group G: Photoelectric reflectors
- H** Group H: Sensor tester

Go to page 298 for details

**CABLES**  
 Cable lengths available:  
 2 m, 5 m, 10 m  
 other customised lengths possible

# CUBIC 4050 4050 SERIES

FAMILY	OPERATING PRINCIPLE	SENSING RANGE (mm)	HOUSING SIZE (mm)	LIGHT SOURCE
CUBIC 4050 – 4050 SERIES		500	40 × 50	LED, red 660 nm
		500	40 × 50	LED, red 660 nm
		500	40 × 50	LED, red 660 nm
		500	40 × 50	LED, red 660 nm
		1,200	40 × 50	LED, white
		1,200	40 × 50	LED, white
		1,200	40 × 50	LED, white
		1,200	40 × 50	LED, white
		4,000	40 × 50	LED, red 680 nm
		4,000	40 × 50	LED, red 680 nm
		4,000	40 × 50	LED, red 680 nm
		4,000	40 × 50	LED, red 680 nm
		50,000	40 × 50	LED, red 640 nm
		50,000	40 × 50	LED, red 640 nm
		50,000	40 × 50	LED, red 640 nm



KEY ADVANTAGES

- ✓ Compact plastic housing, 40 × 50 × 15 mm
- ✓ Excellent background suppression characteristics
- ✓ Reflex types with special autocollimation optics
- ✓ Adjustable connector



	HOUSING MATERIAL	CABLE	CONNECTOR	IO-Link	SWITCHING FREQUENCY (Hz)	AMBIENT TEMPERATURE	DEGREE OF PROTECTION	PART REFERENCE	ACCESSORIES (SEE PAGE 144)
	PBTP	PVC			500	-5 ... +55°C	IP67	LHK-4150-101	F H
	PBTP	PVC			500	-5 ... +55°C	IP67	LHK-4150-103	F H
	PBTP		M12		500	-5 ... +55°C	IP67	LHS-4150-101	C F H
	PBTP		M12		500	-5 ... +55°C	IP67	LHS-4150-103	C F H
	PBTP	PVC			4,000	-5 ... +55°C	IP67	LTK-4150-101	F H
	PBTP	PVC			4,000	-5 ... +55°C	IP67	LTK-4150-103	F H
	PBTP		M12		4,000	-5 ... +55°C	IP67	LTS-4150-101	C F H
	PBTP		M12		4,000	-5 ... +55°C	IP67	LTS-4150-103	C F H
	PBTP	PVC			1,500	-5 ... +55°C	IP67	LRK-4150-101	F G H
	PBTP	PVC			1,500	-5 ... +55°C	IP67	LRK-4150-103	F G H
	PBTP		M12		1,500	-5 ... +55°C	IP67	LRS-4150-101	C F G H
	PBTP		M12		1,500	-5 ... +55°C	IP67	LRS-4150-103	C F G H
	PBTP	PVC			1,500	-5 ... +55°C	IP67	LLK-4150-001	F H
	PBTP	PVC			1,500	-5 ... +55°C	IP67	LLK-4150-003	F H
	PBTP		M12		1,500	-5 ... +55°C	IP67	LLS-4150-001	C F H
	PBTP		M12		1,500	-5 ... +55°C	IP67	LLS-4150-003	C F H
	PBTP	PVC			1,500	-5 ... +55°C	IP67	LLK-4150-000	F H
	PBTP		M12		1,500	-5 ... +55°C	IP67	LLS-4150-000	C F H

## COMMON FEATURES

**Supply Voltage range** 10 ... 30 VDC

## OUTPUT







**Sensor type**  
 [LH] Background suppression — see p. 196  
**[xx][x]-C55PA-[xxx]-[xxx]-[xxx]** — see p. 196  
**Emission type** — see p. 196  
 [L] Laser

Reference key on page 196

## OPERATING PRINCIPLE

 Background suppression

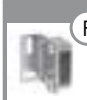

## ACCESSORIES

-  **A** Group A: M8 3-pin  
Sub-group: Field attachable connectors  
Sub-group: Distribution boxes
-  **B** Group B: M8 4-pin  
Sub-group: Field attachable connectors
-  **C** Group C: M12 4-pin  
Sub-group: Field attachable connectors  
Sub-group: Distribution boxes
-  **D** Group D: M12 AC/DC 3-pin
-  **E** Group E: Universal mounting brackets  
Sub-group: Mechanical stops
-  **F** Group F: Photoelectric mounting brackets
-  **G** Group G: Photoelectric reflectors
-  **H** Group H: Sensor tester

Go to page 298 for details

 **CABLES**  
 Cable lengths available:  
 2 m, 5 m, 10 m  
 other customised lengths possible

# CUBIC C55 C55 SERIES

FAMILY	OPERATING PRINCIPLE	SENSING RANGE (mm)	HOUSING SIZE (mm)	LIGHT SOURCE
CUBIC C55 – C55 SERIES		5,000	50 × 50 (C55)	⚠ Laser class 1, red 650 nm
		5,000	50 × 50 (C55)	⚠ Laser class 1, red 650 nm

CUBIC C55 – C55 SERIES



**KEY ADVANTAGES**

- ✓ Compact plastic housing 50 × 50 × 23 mm, IP67 & IP69K, Ecolab certified
- ✓ Time-Of-Flight principle for background suppression
- ✓ Laser class 1 emission
- ✓ Range up to 5,000 mm
- ✓ Reliable detection of tilted objects
- ✓ Ecolab tested and approved



	HOUSING MATERIAL	CABLE	CONNECTOR	IO-Link	SWITCHING FREQUENCY (Hz)	AMBIENT TEMPERATURE	DEGREE OF PROTECTION	PART REFERENCE	ACCESSORIES (SEE PAGE 146)
	ABS		M12		500	-40 ... +60°C	IP67 / IP69K	LHL-C55PA-TMS-107-501	
	ABS		M12	IO-Link	500	-40 ... +60°C	IP67 / IP69K	LHL-C55PA-TMS-607-501	





## APPLICATION

**Miniature photoelectric sensor, mounted in existing structural space of conveyor, detects presence of small parts**

A miniature conveyor system uses photoelectric sensors flush-mounted in the conveyor structure itself to detect the presence of small parts. To avoid impairing conveyor function, existing slots in the conveyor had to be widened to accommodate standard sensors. However, by switching to Contrinex Miniature sensors with a diameter of just 4 mm, mounting was possible without modifying the existing slot, saving time and installation costs.

## INDUSTRIES

Packaging, logistics, materials handling, assembly, automation, robotics, precision engineering, semiconductors, electronics, vending machines, miniature conveyors, grippers



*Micromechanical grippers*



*PCB component presence check*



*Detection of small parts*



*Packaging systems*

# MINIATURE PHOTOELECTRIC SENSORS

## SMALLEST ON THE MARKET

The Contrinex **Miniature** range packs exceptional position- and presence-sensing performance into the smallest self-contained photoelectric sensors on the market. Designers have the choice of through-beam or diffuse sensors in **Ø4** and **M5** cylindrical metal housings that offer multiple mounting methods and beam orientation. For fully embedded applications, **M5** and **Ø4** sensors produce focused, cylindrical light beams.

### KEY ADVANTAGES

#### D04 / M05 / 0507 series

- ✓ Rugged diffuse or through-beam sensors in steel housing: Ø4, M5 or 5 × 7 × 40 mm
- ✓ Extremely compact self-contained photoelectric sensors
- ✓ Accurate target detection due to focused red light beam
- ✓  IO-Link

#### C12 series

- ✓ Plastic housing, 13 × 21/27 × 7 mm
- ✓ Red pinpoint LED, small visible light spot
- ✓ Long sensing ranges
- ✓ Excellent background suppression up to 120 mm with 3-turn potentiometer

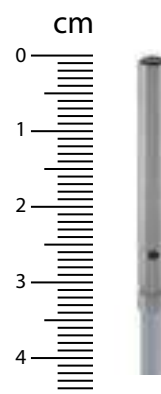

### PRODUCT OVERVIEW

 IO-Link

SERIES Housing size mm	D04 Ø4	M05 M5	0507 □ 5 × 7 × 40	C12 □ 13 × 21/27 × 7
Diffuse	12/24/60/120	12/24/60/120	20/50/90	–
Background suppression	–	–	–	15/30/120
Reflex	–	–	–	3,000
Through-beam	600	600	–	2,000

### ACCESSORIES

Go to page 298 to see all the accessories

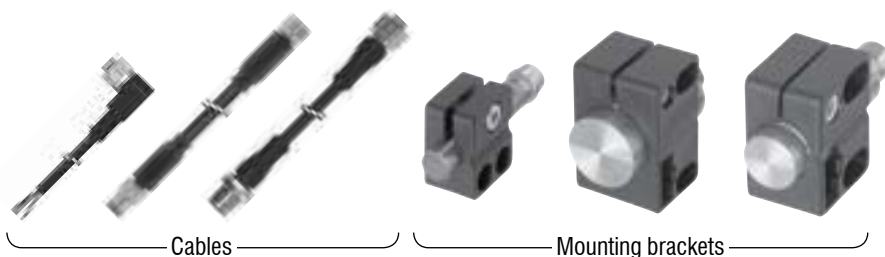

Cables

Mounting brackets

## COMMON FEATURES

<b>Supply Voltage range</b>	10 ... 30 VDC
<b>Output</b>	PNP Light-ON (Diffuse) PNP Dark-ON (Through)*

\*Other types available: NPN Light-ON, NPN Dark-ON

## OUTPUT

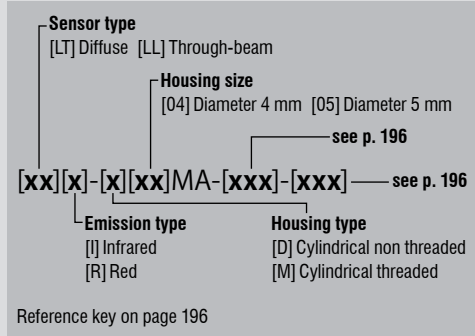

## OPERATING PRINCIPLE

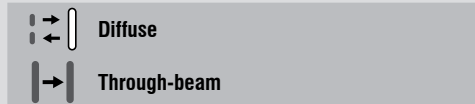

## ACCESSORIES

- A** Group A: M8 3-pin  
Sub-group: Field attachable connectors  
Sub-group: Distribution boxes
- B** Group B: M8 4-pin  
Sub-group: Field attachable connectors
- C** Group C: M12 4-pin  
Sub-group: Field attachable connectors  
Sub-group: Distribution boxes
- D** Group D: M12 AC/DC 3-pin
- E** Group E: Universal mounting brackets  
Sub-group: Mechanical stops
- F** Group F: Photoelectric mounting brackets
- G** Group G: Photoelectric reflectors
- H** Group H: Sensor tester

Go to page 298 for details

**CABLES**  
Cable lengths available:  
2 m, 5 m, 10 m  
other customised lengths possible

# CYLINDRICAL D04/M05 D04/M05 SERIES

FAMILY	OPERATING PRINCIPLE	SENSING RANGE (mm)	HOUSING SIZE (mm)	LIGHT SOURCE
CYLINDRICAL D04/M05 – D04/M05 SERIES		12	Ø 4	LED, red 680 nm
		12	Ø 4	LED, red 680 nm
		12	Ø 4	LED, red 680 nm
		12	Ø 4	LED, infrared 880 nm
		24	Ø 4	LED, red 680 nm
		24	Ø 4	LED, red 680 nm
		24	Ø 4	LED, red 680 nm
		24	Ø 4	LED, infrared 880 nm
		24	Ø 4	LED, infrared 880 nm
		24	Ø 4	LED, infrared 880 nm
		60	Ø 4	LED, red 680 nm
		60	Ø 4	LED, red 680 nm
		60	Ø 4	LED, red 680 nm
		120	Ø 4	LED, red 680 nm
		120	Ø 4	LED, red 680 nm
		600	Ø 4	LED, red 680 nm
		600	Ø 4	LED, red 680 nm
		600	Ø 4	LED, red 680 nm
		12	M5	LED, red 680 nm
		12	M5	LED, red 680 nm
	12	M5	LED, red 680 nm	
	12	M5	LED, infrared 880 nm	
	24	M5	LED, red 680 nm	



KEY ADVANTAGES

- ✓ Rugged metal housing
- ✓ Rugged PBT/PMMA sensing face, scratch & chemically resistant
- ✓ Shock & vibration resistant due to fully vacuum-potted electronics
- ✓ Accurate target detection due to cylindrical light beam



	HOUSING MATERIAL	CABLE	CONNECTOR	IO-Link	SWITCHING FREQUENCY (Hz)	AMBIENT TEMPERATURE	DEGREE OF PROTECTION	PART REFERENCE*	ACCESSORIES (SEE PAGE 150)
	Stainless steel V2A	PUR		IO-Link	1,000	-25 ... +65°C	IP67	LTR-D04MA-NSK-403	E H
	Stainless steel V2A	0.3 m PUR	M8	IO-Link	1,000	-25 ... +65°C	IP67	LTR-D04MA-NSV-403	A E H
	Stainless steel V2A		M8	IO-Link	1,000	-25 ... +65°C	IP67	LTR-D04MA-NSS-403	A E H
	Stainless steel V2A	PUR		IO-Link	1,000	-25 ... +65°C	IP67	LTI-D04MA-NSK-403	E H
	Stainless steel V2A	PUR		IO-Link	1,000	-25 ... +65°C	IP67	LTR-D04MA-NMK-403	E H
	Stainless steel V2A	0.3 m PUR	M8	IO-Link	1,000	-25 ... +65°C	IP67	LTR-D04MA-NMV-403	A E H
	Stainless steel V2A		M8	IO-Link	1,000	-25 ... +65°C	IP67	LTR-D04MA-NMS-403	A E H
	Stainless steel V2A	PUR		IO-Link	1,000	-25 ... +65°C	IP67	LTI-D04MA-NMK-403	E H
	Stainless steel V2A	0.3 m PUR	M8	IO-Link	1,000	-25 ... +65°C	IP67	LTI-D04MA-NMV-403	A E H
	Stainless steel V2A		M8	IO-Link	1,000	-25 ... +65°C	IP67	LTI-D04MA-NMS-403	A E H
	Stainless steel V2A	PUR		IO-Link	1,000	-25 ... +65°C	IP67	LTR-D04MA-NLK-403	E H
	Stainless steel V2A	0.3 m PUR	M8	IO-Link	1,000	-25 ... +65°C	IP67	LTR-D04MA-NLV-403	A E H
	Stainless steel V2A		M8	IO-Link	1,000	-25 ... +65°C	IP67	LTR-D04MA-NLS-403	A E H
	Stainless steel V2A	PUR		IO-Link	1,000	-25 ... +65°C	IP67	LTR-D04MA-WXK-403	E H
	Stainless steel V2A	0.3 m PUR	M8	IO-Link	1,000	-25 ... +65°C	IP67	LTR-D04MA-WXV-403	B E H
	Stainless steel V2A	PUR		IO-Link	1,000	-25 ... +65°C	IP67	LLR-D04MA-NMK-404	E H
	Stainless steel V2A	0.3 m PUR	M8	IO-Link	1,000	-25 ... +65°C	IP67	LLR-D04MA-NMV-404	A E H
	Stainless steel V2A		M8	IO-Link	1,000	-25 ... +65°C	IP67	LLR-D04MA-NMS-404	A E H
	Stainless steel V2A	PUR		IO-Link	1,000	-25 ... +65°C	IP67	LTR-M05MA-NSK-403	E H
	Stainless steel V2A	0.3 m PUR	M8	IO-Link	1,000	-25 ... +65°C	IP67	LTR-M05MA-NSV-403	A E H
	Stainless steel V2A		M8	IO-Link	1,000	-25 ... +65°C	IP67	LTR-M05MA-NSS-403	A E H
	Stainless steel V2A		M8	IO-Link	1,000	-25 ... +65°C	IP67	LTI-M05MA-NSS-403	A E H
	Stainless steel V2A	PUR		IO-Link	1,000	-25 ... +65°C	IP67	LTR-M05MA-NMK-403	E H

## COMMON FEATURES

<b>Supply Voltage range</b>	10 ... 30 VDC
<b>Output</b>	PNP Light-ON (Diffuse) PNP Dark-ON (Through)*

\*Other types available: NPN Light-ON, NPN Dark-ON

## OUTPUT

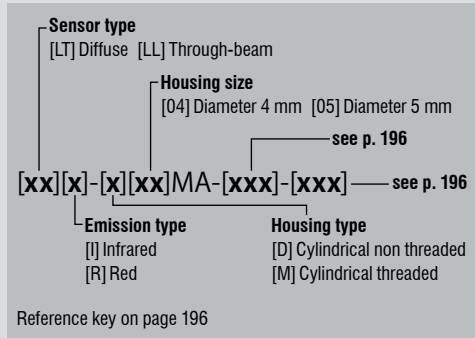

## OPERATING PRINCIPLE

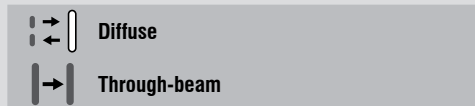

## ACCESSORIES

- A** Group A: M8 3-pin  
Sub-group: Field attachable connectors  
Sub-group: Distribution boxes
- B** Group B: M8 4-pin  
Sub-group: Field attachable connectors
- C** Group C: M12 4-pin  
Sub-group: Field attachable connectors  
Sub-group: Distribution boxes
- D** Group D: M12 AC/DC 3-pin
- E** Group E: Universal mounting brackets  
Sub-group: Mechanical stops
- F** Group F: Photoelectric mounting brackets
- G** Group G: Photoelectric reflectors
- H** Group H: Sensor tester

Go to page 298 for details

**CABLES**  
Cable lengths available:  
2 m, 5 m, 10 m  
other customised lengths possible

# CYLINDRICAL D04/M05 D04/M05 SERIES

FAMILY	OPERATING PRINCIPLE	SENSING RANGE (mm)	HOUSING SIZE (mm)	LIGHT SOURCE
CYLINDRICAL D04/M05 – D04/M05 SERIES		24	M5	LED, red 680 nm
		24	M5	LED, red 680 nm
		24	M5	LED, infrared 880 nm
		24	M5	LED, infrared 880 nm
		24	M5	LED, infrared 880 nm
		60	M5	LED, red 680 nm
		60	M5	LED, red 680 nm
		60	M5	LED, red 680 nm
		120	M5	LED, red 680 nm
		120	M5	LED, red 680 nm
		600	M5	LED, red 680 nm
		600	M5	LED, red 680 nm
		600	M5	LED, red 680 nm



KEY ADVANTAGES

- ✓ Rugged metal housing
- ✓ Rugged PBT/PMMA sensing face, scratch & chemically resistant
- ✓ Shock & vibration resistant due to fully vacuum-potted electronics
- ✓ Accurate target detection due to cylindrical light beam



	HOUSING MATERIAL	CABLE	CONNECTOR	IO-Link	SWITCHING FREQUENCY (Hz)	AMBIENT TEMPERATURE	DEGREE OF PROTECTION	PART REFERENCE*	ACCESSORIES (SEE PAGE 152)
	Stainless steel V2A	0.3 m PUR	M8	IO-Link	1,000	-25 ... +65°C	IP67	LTR-M05MA-NMV-403	A E H
	Stainless steel V2A		M8	IO-Link	1,000	-25 ... +65°C	IP67	LTR-M05MA-NMS-403	A E H
	Stainless steel V2A	PUR		IO-Link	1,000	-25 ... +65°C	IP67	LTI-M05MA-NMK-403	E H
	Stainless steel V2A	0.3 m PUR	M8	IO-Link	1,000	-25 ... +65°C	IP67	LTI-M05MA-NMV-403	A E H
	Stainless steel V2A		M8	IO-Link	1,000	-25 ... +65°C	IP67	LTI-M05MA-NMS-403	A E H
	Stainless steel V2A	PUR		IO-Link	1,000	-25 ... +65°C	IP67	LTR-M05MA-NLK-403	E H
	Stainless steel V2A	0.3 m PUR	M8	IO-Link	1,000	-25 ... +65°C	IP67	LTR-M05MA-NLV-403	A E H
	Stainless steel V2A		M8	IO-Link	1,000	-25 ... +65°C	IP67	LTR-M05MA-NLS-403	A E H
	Stainless steel V2A	PUR		IO-Link	1,000	-25 ... +65°C	IP67	LTR-M05MA-WXK-403	E H
	Stainless steel V2A	0.3 m PUR	M8	IO-Link	1,000	-25 ... +65°C	IP67	LTR-M05MA-WXV-403	B E H
	Stainless steel V2A	PUR		IO-Link	1,000	-25 ... +65°C	IP67	LLR-M05MA-NMK-404	E H
	Stainless steel V2A	0.3 m PUR	M8	IO-Link	1,000	-25 ... +65°C	IP67	LLR-M05MA-NMV-404	A E H
	Stainless steel V2A		M8	IO-Link	1,000	-25 ... +65°C	IP67	LLR-M05MA-NMS-404	A E H

## COMMON FEATURES

**Supply Voltage range** 10 ... 30 VDC

## OUTPUT

Sensor type  
[T] Diffuse

L[x][x]-0507-[xxx]-[xxx] — see p. 197









Connection  
[K] Cable — see p. 197

Reference key on page 197

## OPERATING PRINCIPLE

 Diffuse

## ACCESSORIES

-  **A** Group A: M8 3-pin  
Sub-group: Field attachable connectors  
Sub-group: Distribution boxes
-  **B** Group B: M8 4-pin  
Sub-group: Field attachable connectors
-  **C** Group C: M12 4-pin  
Sub-group: Field attachable connectors  
Sub-group: Distribution boxes
-  **D** Group D: M12 AC/DC 3-pin
-  **E** Group E: Universal mounting brackets  
Sub-group: Mechanical stops
-  **F** Group F: Photoelectric mounting brackets
-  **G** Group G: Photoelectric reflectors
-  **H** Group H: Sensor tester





Go to page 298 for details



### CABLES

Cable lengths available:  
2 m, 5 m, 10 m  
other customised lengths possible

# CUBIC 0507 0507 SERIES

FAMILY	OPERATING PRINCIPLE	SENSING RANGE (mm)	HOUSING SIZE (mm)	LIGHT SOURCE
CUBIC 0507 – 0507 SERIES		20	5 × 7	LED, infrared 880 nm
		20	5 × 7	LED, infrared 880 nm
		50	5 × 7	LED, infrared 880 nm
		50	5 × 7	LED, infrared 880 nm
		90	5 × 7	LED, infrared 880 nm



**KEY ADVANTAGES**

- ✓ Rugged metal housing
- ✓ Rugged sapphire-glass or glass sensing face, scratch and chemically resistant
- ✓ Shock & vibration resistant due to fully vacuum-potted electronics
- ✓ Accurate target detection due to cylindrical light beam



	HOUSING MATERIAL	CABLE	CONNECTOR	IO-Link	SWITCHING FREQUENCY (Hz)	AMBIENT TEMPERATURE	DEGREE OF PROTECTION	PART REFERENCE	ACCESSORIES (SEE PAGE 154)
	Stainless steel V2A	PVC			250	0 ... +55°C	IP67	LTK-0507-301-501	H
	Stainless steel V2A	PVC			250	0 ... +55°C	IP67	LTK-0507-303-501	H
	Stainless steel V2A	PVC			250	0 ... +55°C	IP67	LTK-0507-301	H
	Stainless steel V2A	PVC			250	0 ... +55°C	IP67	LTK-0507-303	H
	Stainless steel V2A	PVC			250	0 ... +55°C	IP67	LTK-0507-303-502	H

# PHOTOELECTRIC SENSORS MINIATURE

## COMMON FEATURES

**Supply Voltage range** 10 ... 30 VDC

## OUTPUT

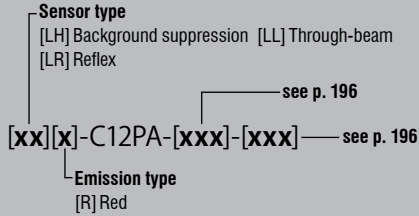

Reference key on page 196

## OPERATING PRINCIPLE

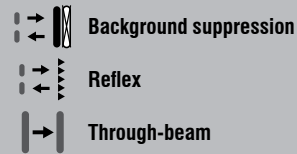

## ACCESSORIES

- A** Group A: M8 3-pin  
Sub-group: Field attachable connectors  
Sub-group: Distribution boxes
- B** Group B: M8 4-pin  
Sub-group: Field attachable connectors
- C** Group C: M12 4-pin  
Sub-group: Field attachable connectors  
Sub-group: Distribution boxes
- D** Group D: M12 AC/DC 3-pin
- E** Group E: Universal mounting brackets  
Sub-group: Mechanical stops
- F** Group F: Photoelectric mounting brackets
- G** Group G: Photoelectric reflectors
- H** Group H: Sensor tester

Go to page 298 for details

**CABLES**  
 Cable lengths available:  
 2 m, 5 m, 10 m  
 other customised lengths possible

# CUBIC C12 C12 SERIES

FAMILY	OPERATING PRINCIPLE	SENSING RANGE (mm)	HOUSING SIZE (mm)	LIGHT SOURCE
CUBIC C12 – C12 SERIES		120	13 × 27 (C12)	Pinpoint LED, red 640 nm
		120	13 × 27 (C12)	Pinpoint LED, red 640 nm
		120	13 × 27 (C12)	Pinpoint LED, red 640 nm
		120	13 × 27 (C12)	Pinpoint LED, red 640 nm
		18	13 × 21 (C12)	Pinpoint LED, red 640 nm
		18	13 × 21 (C12)	Pinpoint LED, red 640 nm
		18	13 × 21 (C12)	Pinpoint LED, red 640 nm
		18	13 × 21 (C12)	Pinpoint LED, red 640 nm
		36	13 × 21 (C12)	Pinpoint LED, red 640 nm
		36	13 × 21 (C12)	Pinpoint LED, red 640 nm
		36	13 × 21 (C12)	Pinpoint LED, red 640 nm
		36	13 × 21 (C12)	Pinpoint LED, red 640 nm
		3,000	13 × 21 (C12)	Pinpoint LED, red 640 nm
		3,000	13 × 21 (C12)	Pinpoint LED, red 640 nm
		3,000	13 × 21 (C12)	Pinpoint LED, red 640 nm
		3,000	13 × 21 (C12)	Pinpoint LED, red 640 nm
		2,000	13 × 21 (C12)	Pinpoint LED, red 640 nm
		2,000	13 × 21 (C12)	Pinpoint LED, red 640 nm
		2,000	13 × 21 (C12)	Pinpoint LED, red 640 nm
		2,000	13 × 21 (C12)	Pinpoint LED, red 640 nm
	2,000	13 × 21 (C12)	Pinpoint LED, red 640 nm	
	2,000	13 × 21 (C12)	Pinpoint LED, red 640 nm	



KEY ADVANTAGES

- ✓ Plastic housing, 13 × 21/27 × 7 mm
- ✓ Red pinpoint LED, small visible light spot
- ✓ Long sensing ranges
- ✓ Excellent background suppression up to 120 mm with 3-turn potentiometer



	HOUSING MATERIAL	CABLE	CONNECTOR	IO-Link	SWITCHING FREQUENCY (Hz)	AMBIENT TEMPERATURE	DEGREE OF PROTECTION	PART REFERENCE	ACCESSORIES (SEE PAGE 156)
	ABS	PVC			800	-20 ... +50°C	IP67	LHR-C12PA-PLK-303	H
	ABS	0.2 m PVC	M8		800	-20 ... +50°C	IP67	LHR-C12PA-PLV-303	A H
	ABS	PVC			800	-20 ... +50°C	IP67	LHR-C12PA-PLK-301	H
	ABS	0.2 m PVC	M8		800	-20 ... +50°C	IP67	LHR-C12PA-PLV-301	A H
	ABS	PVC			800	-20 ... +50°C	IP67	LHR-C12PA-NSK-303	H
	ABS	0.2 m PVC	M8		800	-20 ... +50°C	IP67	LHR-C12PA-NSV-303	A H
	ABS	PVC			800	-20 ... +50°C	IP67	LHR-C12PA-NSK-301	H
	ABS	0.2 m PVC	M8		800	-20 ... +50°C	IP67	LHR-C12PA-NSV-301	A H
	ABS	PVC			800	-20 ... +50°C	IP67	LHR-C12PA-NMK-303	H
	ABS	0.2 m PVC	M8		800	-20 ... +50°C	IP67	LHR-C12PA-NMV-303	A H
	ABS	PVC			800	-20 ... +50°C	IP67	LHR-C12PA-NMK-301	H
	ABS	0.2 m PVC	M8		800	-20 ... +50°C	IP67	LHR-C12PA-NMV-301	A H
	ABS	PVC			800	-20 ... +50°C	IP67	LRR-C12PA-NMK-304	G H
	ABS	0.2 m PVC	M8		800	-20 ... +50°C	IP67	LRR-C12PA-NMV-304	A G H
	ABS	PVC			800	-20 ... +50°C	IP67	LRR-C12PA-NMK-302	G H
	ABS	0.2 m PVC	M8		800	-20 ... +50°C	IP67	LRR-C12PA-NMV-302	A G H
	ABS	PVC			800	-20 ... +50°C	IP67	LLR-C12PA-NMK-300	H
	ABS	0.2 m PVC	M8		800	-20 ... +50°C	IP67	LLR-C12PA-NMV-300	A H
	ABS	PVC			800	-20 ... +50°C	IP67	LLR-C12PA-NMK-304	H
	ABS	0.2 m PVC	M8		800	-20 ... +50°C	IP67	LLR-C12PA-NMV-304	A H
	ABS	PVC			800	-20 ... +50°C	IP67	LLR-C12PA-NMK-302	H
	ABS	0.2 m PVC	M8		800	-20 ... +50°C	IP67	LLR-C12PA-NMV-302	A H

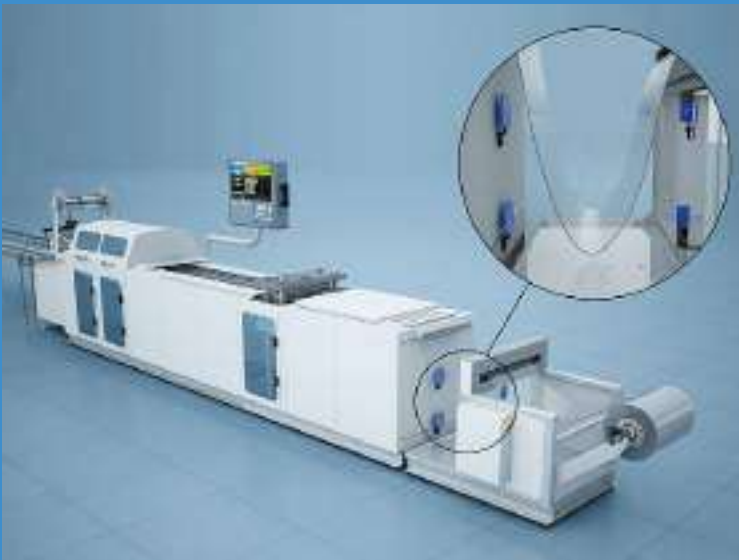

## APPLICATION

### **Transparent-object sensors with patented UV technology detect presence of clear plastic sheet during thermoforming**

During automated packaging, high-speed thermoforming lines produce transparent plastic blister-trays from continuous reel-stock material. Transparent-object sensors with patented UV technology detect the presence of the transparent plastic sheet as it is unwound, ensuring the material is correctly tensioned as it enters the loading station. False detection is avoided, ensuring reliable operation with little or no downtime. Ecolab-certified, these sensors are also suitable for the packaging of medical products.

## INDUSTRIES

Packaging, logistics, materials handling, food and beverage, filling machines, pharmaceutical industry



*Detection of clear plastic bottles*



*Pharmaceutical vial processing*



*Detection of glass sheet on conveyor*



*Packaging systems*



# TRANSPARENT OBJECT

## PHOTOELECTRIC SENSORS

### OUTSTANDING RELIABILITY AND EASE OF ADJUSTMENT

The **TRU-C23** photoelectric sensor is ideally suited for the presence control of transparent objects. Its patented technology comprises an LED that emits polarized **UV light** and a suitable reflector. Special optics with autocollimation ensure reliable detection and no blind zone. For applications requiring the detection of thicker or larger transparent objects, the **C23 Transparent Standard** provides a highly favorable price-performance ratio.

#### KEY ADVANTAGES

- ✓  **IO-Link** interface available on PNP types
- ✓ Versions with stability alarm as second output
- ✓ Mutual interference immunity
- ✓ Adjustment by teach button or  **IO-Link**
- ✓ Enclosure rating IP67, Ecolab approved

#### C23 Transparent UV

- ✓ Extremely reliable detection thanks to strong absorption of UV light by plastic and glass material
- ✓ Easy sensor set-up, even for thinnest transparent objects
- ✓ Low environmental sensitivity minimizes threshold adjustments and maximizes uptime
- ✓ Autocollimated, polarized UV light beam eliminates blind zone, allowing detection of targets close to the sensor or through a small notch
- ✓ Sensing range up to 1,200 mm

#### C23 Transparent Standard

- ✓ Red polarized light source
- ✓ Calibrated sensing range up to 5,000 mm
- ✓ Sensitivity adjustment via teach button,  **IO-Link** or potentiometer



#### PRODUCT OVERVIEW

 **IO-Link**

SERIES Housing size mm	C23 UV Light □ 20 × 30 × 10	C23 Red Light □ 20 × 30 × 10
Reflex (s <sub>n</sub> mm)	1,200	5,000

#### ACCESSORIES

Go to page 298 to see all the accessories

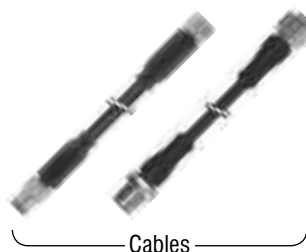

## COMMON FEATURES

Supply Voltage range	10 ... 30 VDC
Output	PNP Light-ON*

\* Other types available: PNP, NPN, Dark-ON, Light-ON

## OUTPUT

**Sensor type**  
 [TR] Transparent reflex  
**Emission type**  
 [R] Red [U] UV

**[xx][x]-C23PA-[xxx]-[xxx]** — see p. 196

Reference key on page 196

## OPERATING PRINCIPLE

**Transparent reflex**

## ACCESSORIES







- 
**A Group A: M8 3-pin**  
 Sub-group: Field attachable connectors  
 Sub-group: Distribution boxes
- 
**B Group B: M8 4-pin**  
 Sub-group: Field attachable connectors
- 
**C Group C: M12 4-pin**  
 Sub-group: Field attachable connectors  
 Sub-group: Distribution boxes
- 
**D Group D: M12 AC/DC 3-pin**
- 
**E Group E: Universal mounting brackets**  
 Sub-group: Mechanical stops
- 
**F Group F: Photoelectric mounting brackets**
- 
**G Group G: Photoelectric reflectors**
- 
**H Group H: Sensor tester**

Go to page 298 for details

**CABLES**  
 Cable lengths available:  
 2 m, 5 m, 10 m  
 other customised lengths possible

# CUBIC C23

# C23 SERIES

FAMILY	OPERATING PRINCIPLE	SENSING RANGE (mm)	HOUSING SIZE (mm)	LIGHT SOURCE
CUBIC C23 – C23 SERIES		1,200	20 × 30 (C23)	LED, UV 275 nm, Risk Group 2
		1,200	20 × 30 (C23)	LED, UV 275 nm, Risk Group 2
		5,000	20 × 30 (C23)	LED, red 630 nm
		5,000	20 × 30 (C23)	LED, red 630 nm
		5,000	20 × 30 (C23)	LED, red 630 nm
		5,000	20 × 30 (C23)	LED, red 630 nm

CUBIC C23 – C23 SERIES



KEY ADVANTAGES

- ✓ IO-Link interface available on PNP types
- ✓ Versions with stability alarm as second output
- ✓ Mutual interference immunity
- ✓ Adjustment by teach button, potentiometer or IO-Link
- ✓ Enclosure rating IP67, Ecolab approved



	HOUSING MATERIAL	CABLE	CONNECTOR	IO-Link	SWITCHING FREQUENCY (Hz)	AMBIENT TEMPERATURE	DEGREE OF PROTECTION	PART REFERENCE*	ACCESSORIES (SEE PAGE 160)
	ABS			IO-Link	1,000	-25 ... +65°C	IP67	TRU-C23PA-TMK-603	
	ABS			IO-Link	1,000	-25 ... +65°C	IP67	TRU-C23PA-TMS-603	
	ABS			IO-Link	1,500	-25 ... +65°C	IP67	TRR-C23PA-TMK-603	
	ABS			IO-Link	1,500	-25 ... +65°C	IP67	TRR-C23PA-TMS-603	
	ABS			IO-Link	1,500	-25 ... +65°C	IP67	TRR-C23PA-PMK-603	
	ABS			IO-Link	1,500	-25 ... +65°C	IP67	TRR-C23PA-PMS-603	



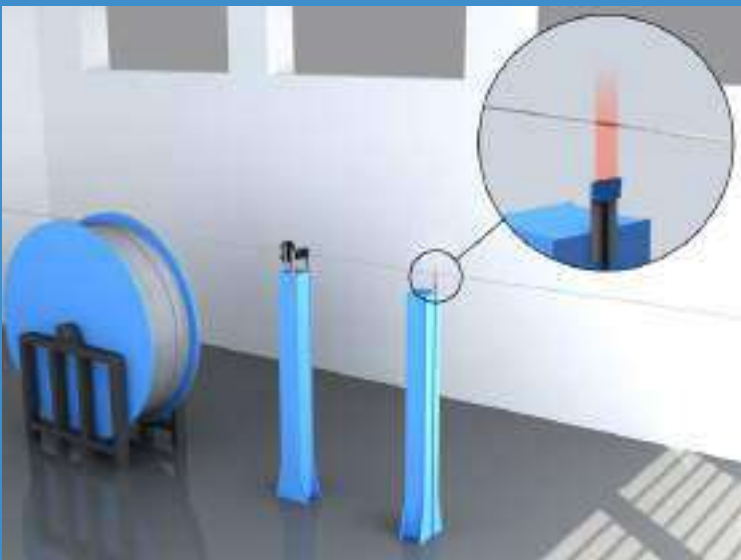

## APPLICATION

### Photoelectric fiber-optic sensor detects broken parking-brake cable during manufacture

During manufacture of automotive parking-brake cable, multiple strands of steel wire are twisted together, forming a single cable. After twisting, cable passes to the next process in an unsupported, continuous length. Occasionally, the cable breaks, compromising safety and damaging equipment. Although the cable's exact path is unpredictable, a multi-beam fiber-optic sensor detects its presence, interrupting the process if it breaks.

## INDUSTRIES

Packaging, logistics, materials handling, robotics, precision engineering, printed circuit board production, electronics, vending machines, special machinery, quality control



*Printed circuit board production*



*Presence sensing by industrial robot*



*Packaging systems*



*Robotics*

# FIBER-OPTIC PHOTOELECTRIC SENSORS

## RELIABLE SHORT- AND LONG-RANGE SENSING

With self-contained fiber-optic sensors available in housings as small as 30 × 30 × 15 mm, and several models of small DIN-rail mounted amplifiers that accommodate multiple-sensor applications, the Contrinex range is highly versatile. A choice of **synthetic** or **glass optical fibers** provides options for even the most demanding applications.

### KEY ADVANTAGES

#### Fiber-optic sensors

- ✓ Robust 3030 series (30 × 30 × 15 mm)
- ✓ DIN-rail mounted 3060 series (31 × 60 × 10 mm) suitable for multiple-sensor applications
- ✓ Distance setting by potentiometer or teach-in
- ✓  IO-Link

#### Fibers

- ✓ Large selection of types, including cylindrical light beam, multi-beam and low & high temperature
- ✓ Diffuse or through-beam sensing, axial or radial
- ✓ Synthetic fibers with bending radii from 2 mm, suitable for cutting on-site
- ✓ Glass fibers for high temperatures and aggressive environment



### PRODUCT OVERVIEW

 IO-Link		
SERIES	3030	3060
Housing size mm	□ 30 × 30 × 15	□ 30 × 60 × 10
Fiber-optic amplifier (s <sub>n</sub> mm)	60/120	200

### OPTICAL FIBERS OVERVIEW

Housing size		Ø2.3 mm	M3	Ø3.2 mm	M4	Ø4.5 mm	M5	M6	□ 18 × 32 mm
Synthetic fibers	Diffuse	p. 168	p. 168			p. 170	p. 170	p. 168, 172	p. 168
	Through-beam		p. 170	p. 170	p. 172			p. 174	
Glass fibers	Diffuse							p. 170	
	Through-beam				p. 174				

## COMMON FEATURES

**Supply Voltage range** 10 ... 36 VDC

## OUTPUT

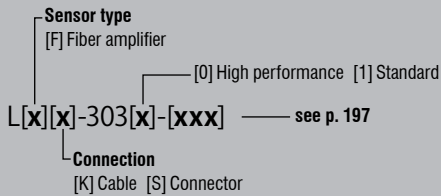

Reference key on page 197

## OPERATING PRINCIPLE



## ACCESSORIES

- A** Group A: M8 3-pin  
 Sub-group: Field attachable connectors  
 Sub-group: Distribution boxes
  - B** Group B: M8 4-pin  
 Sub-group: Field attachable connectors
  - C** Group C: M12 4-pin  
 Sub-group: Field attachable connectors  
 Sub-group: Distribution boxes
  - D** Group D: M12 AC/DC 3-pin
  - E** Group E: Universal mounting brackets  
 Sub-group: Mechanical stops
  - F** Group F: Photoelectric mounting brackets
  - G** Group G: Photoelectric reflectors
  - H** Group H: Sensor tester
- Go to page 298 for details

**CABLES**  
 Cable lengths available:  
 2 m, 5 m, 10 m  
 other customised lengths possible

# CUBIC 3030

# 3030 SERIES

# AMPLIFIER









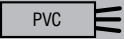

FAMILY	OPERATING PRINCIPLE	SENSING RANGE (mm)	HOUSING SIZE (mm)	LIGHT SOURCE
CUBIC 3030 – 3030 SERIES	or (dependent on selected optical fiber)	60	30 × 30	LED, red 660 nm
		60	30 × 30	LED, red 660 nm
		60	30 × 30	LED, red 660 nm
		60	30 × 30	LED, red 660 nm
		60	30 × 30	LED, red 660 nm
		60	30 × 30	LED, red 660 nm
		60	30 × 30	LED, red 660 nm
		60	30 × 30	LED, red 660 nm
		60	30 × 30	LED, red 660 nm
		120	30 × 30	LED, red 660 nm
		120	30 × 30	LED, red 660 nm
		120	30 × 30	LED, red 660 nm
		120	30 × 30	LED, red 660 nm

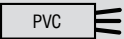

**KEY ADVANTAGES**

- ✓ Fiber-optic amplifiers in rugged Crastin housing 30 × 30 × 15 mm
- ✓ Shock and vibration resistant due to fully potted electronics
- ✓ Sensing range up to 120 mm

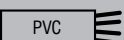

	HOUSING MATERIAL	CABLE	CONNECTOR	IO-Link	SWITCHING FREQUENCY (Hz)	AMBIENT TEMPERATURE	DEGREE OF PROTECTION	PART REFERENCE	ACCESSORIES (SEE PAGE 164)
	PBTP (Crastin)				1,000	−25 ... +55°C	IP67	<b>LFK-3031-301</b>	F H
	PBTP (Crastin)				1,000	−25 ... +55°C	IP67	<b>LFK-3031-302</b>	F H
	PBTP (Crastin)				1,000	−25 ... +55°C	IP67	<b>LFS-3031-301</b>	A F H
	PBTP (Crastin)				1,000	−25 ... +55°C	IP67	<b>LFS-3031-302</b>	A F H
	PBTP (Crastin)				1,000	−25 ... +55°C	IP67	<b>LFK-3031-303</b>	F H
	PBTP (Crastin)				1,000	−25 ... +55°C	IP67	<b>LFK-3031-304</b>	F H
	PBTP (Crastin)				1,000	−25 ... +55°C	IP67	<b>LFS-3031-303</b>	A F H
	PBTP (Crastin)				1,000	−25 ... +55°C	IP67	<b>LFS-3031-304</b>	A F H
	PBTP (Crastin)				1,000	−25 ... +55°C	IP67	<b>LFK-3030-101</b>	F H
	PBTP (Crastin)				1,000	−25 ... +55°C	IP67	<b>LFS-3030-101</b>	B F H
	PBTP (Crastin)				1,000	−25 ... +55°C	IP67	<b>LFK-3030-103</b>	F H
	PBTP (Crastin)				1,000	−25 ... +55°C	IP67	<b>LFS-3030-103</b>	B F H

## COMMON FEATURES

**Supply Voltage range** 10 ... 30 VDC

## OUTPUT

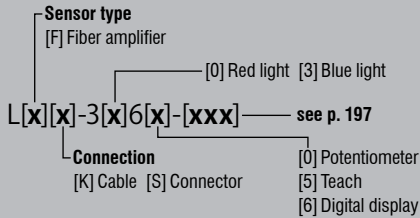

Reference key on page 197

## OPERATING PRINCIPLE



## ACCESSORIES

- A** Group A: M8 3-pin  
Sub-group: Field attachable connectors  
Sub-group: Distribution boxes
- B** Group B: M8 4-pin  
Sub-group: Field attachable connectors
- C** Group C: M12 4-pin  
Sub-group: Field attachable connectors  
Sub-group: Distribution boxes
- D** Group D: M12 AC/DC 3-pin
- E** Group E: Universal mounting brackets  
Sub-group: Mechanical stops
- F** Group F: Photoelectric mounting brackets
- G** Group G: Photoelectric reflectors
- H** Group H: Sensor tester

Go to page 298 for details

**CABLES**  
Cable lengths available:  
2 m, 5 m, 10 m  
other customised lengths possible

# CUBIC 3060 3060 SERIES AMPLIFIER

FAMILY	OPERATING PRINCIPLE	SENSING RANGE (mm)	HOUSING SIZE (mm)	LIGHT SOURCE
CUBIC 3060 – 3060 SERIES	or (dependent on selected optical fiber)	100	31 × 60	LED, blue 465 nm
		100	31 × 60	LED, blue 465 nm
		100	31 × 60	LED, blue 465 nm
		100	31 × 60	LED, blue 465 nm
		200	31 × 60	LED, red 680 nm
		200	31 × 60	LED, red 680 nm
		200	31 × 60	LED, red 680 nm
		200	31 × 60	LED, red 680 nm
		200	31 × 60	LED, red 680 nm
		200	31 × 60	LED, red 680 nm
		200	31 × 60	LED, red 680 nm
		200	31 × 60	LED, red 680 nm
		200	31 × 60	LED, red 680 nm
		200	31 × 60	LED, red 680 nm
		200	31 × 60	LED, red 680 nm



**KEY ADVANTAGES**

- ✓ Complete series of fiber-optic amplifiers for plastic fibers and DIN-rail mounting
- ✓ Small housings 31 × 60 × 10 mm
- ✓ Sensing ranges up to 200 mm
- ✓ IO-Link
- ✓ Blue light version for glass detection

	HOUSING MATERIAL	CABLE	CONNECTOR	IO-Link	SWITCHING FREQUENCY (Hz)	AMBIENT TEMPERATURE	DEGREE OF PROTECTION	PART REFERENCE	ACCESSORIES (SEE PAGE 166)
	PBTP (Crastin)	PVC			1,500	-25 ... +55°C	IP64	LFK-3360-101	H
	PBTP (Crastin)		M8		1,500	-25 ... +55°C	IP64	LFS-3360-101	B H
	PBTP (Crastin)	PVC			1,500	-25 ... +55°C	IP64	LFK-3360-103	H
	PBTP (Crastin)		M8		1,500	-25 ... +55°C	IP64	LFS-3360-103	B H
	PBTP (Crastin)	PVC			1,500	-25 ... +55°C	IP64	LFK-3065-101	H
	PBTP (Crastin)		M8		1,500	-25 ... +55°C	IP64	LFS-3065-101	B H
	PBTP (Crastin)	PVC			1,500	-25 ... +55°C	IP64	LFK-3065-103	H
	PBTP (Crastin)		M8		1,500	-25 ... +55°C	IP64	LFS-3065-103	B H
	PBTP (Crastin)	PVC			1,500	-25 ... +55°C	IP64	LFK-3060-101	H
	PBTP (Crastin)		M8		1,500	-25 ... +55°C	IP64	LFS-3060-101	B H
	PBTP (Crastin)	PVC			1,500	-25 ... +55°C	IP64	LFK-3060-103	H
	PBTP (Crastin)		M8		1,500	-25 ... +55°C	IP64	LFS-3060-103	B H
	PBTP (Crastin)	PVC			4,000	-25 ... +55°C	IP64	LFK-3066-101	H
	PBTP (Crastin)		M8		4,000	-25 ... +55°C	IP64	LFS-3066-101	B H
	PBTP (Crastin)	PVC		IO-Link	4,000	-25 ... +55°C	IP64	LFK-3066-403	H
	PBTP (Crastin)		M8	IO-Link	4,000	-25 ... +55°C	IP64	LFS-3066-403	B H

## OUTPUT

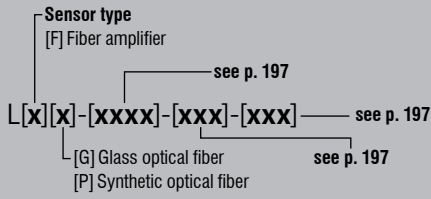

Reference key on page 197

## OPERATING PRINCIPLE



# FIBERS SYNTHETIC & GLASS

FAMILY	OPERATING PRINCIPLE	SENSING RANGE (mm)	FIBER MATERIAL	HOUSING SIZE (mm)
OPTICAL FIBERS	Diffuse	40	Plastic	Ø 2.3
	Diffuse	40	Plastic	M3
	Diffuse	40	Plastic	M3
	Diffuse	90	Plastic	M6
	Diffuse	90	Plastic	M6
	Diffuse	90	Plastic	18 × 32



**KEY ADVANTAGES**

- ✓ Very small dimensions
- ✓ Long sensing ranges
- ✓ Small bending radii
- ✓ Can be cut on site
- ✓ Large selection of types
- ✓ Mechanically rugged sensing head



	CABLE LENGTH	SLEEVE MATERIAL	TEMPERATURE RANGE	TECHNICAL DRAWING	PART REFERENCE
	2 m	PE	-25 ... +70°C		LFP-1012-020
	2 m	PE	-25 ... +70°C		LFP-1001-020
	2 m	PE	-25 ... +70°C		LFP-1004-020
	2 m	PE	-25 ... +70°C		LFP-1102-020
	2 m	PE	-55 ... +105°C		LFP-1002-020-002
	2 m	PE	-25 ... +70°C		LFP-1011-020

## OUTPUT

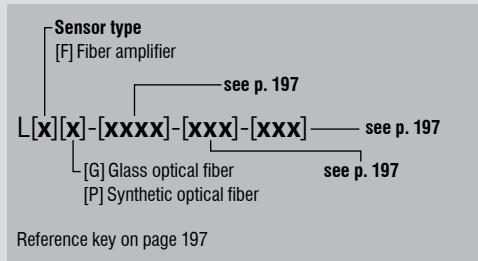

## OPERATING PRINCIPLE

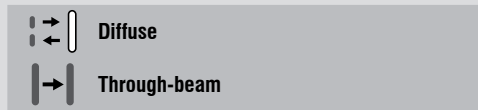

# FIBERS

## SYNTHETIC & GLASS

FAMILY	OPERATING PRINCIPLE	SENSING RANGE (mm)	FIBER MATERIAL	HOUSING SIZE (mm)
OPTICAL FIBERS	Diffuse	100	Plastic	Ø 4.5
	Diffuse	100	Plastic	M5
	Through-beam	120	Plastic	M3
	Through-beam	120	Plastic	M3
	Through-beam	120	Plastic	Ø 3.2
	Diffuse	120	Glass	M6



KEY ADVANTAGES

- ✓ Very small dimensions
- ✓ Long sensing ranges
- ✓ Small bending radii
- ✓ Can be cut on site
- ✓ Large selection of types
- ✓ Mechanically rugged sensing head



	CABLE LENGTH	SLEEVE MATERIAL	TEMPERATURE RANGE	TECHNICAL DRAWING	PART REFERENCE
	2 m	PE	-25 ... +70°C		LFP-1006-020
	2 m	PE	-25 ... +70°C		LFP-1007-020
	2 m	PE	-25 ... +70°C		LFP-2001-020
	2 m	PE	-25 ... +70°C		LFP-2003-020
	2 m	PE	-25 ... +70°C		LFP-2006-020
	0.5 m	Brass sleeve	-25 ... +160°C		LFG-1022-050

## OUTPUT

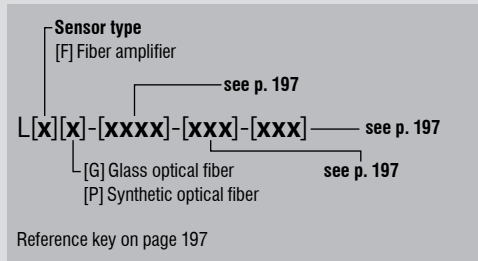

## OPERATING PRINCIPLE

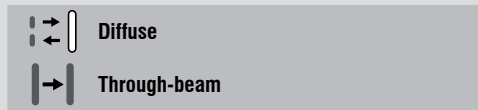

# FIBERS

## SYNTHETIC & GLASS

FAMILY	OPERATING PRINCIPLE	SENSING RANGE (mm)	FIBER MATERIAL	HOUSING SIZE (mm)
OPTICAL FIBERS	Diffuse	120	Plastic	M6
	Diffuse	120	Plastic	M6
	Diffuse	120	Plastic	M6
	Diffuse	120	Plastic	M6
	Diffuse	150	Plastic	M6
	Through-beam	300	Plastic	M4



KEY ADVANTAGES

- ✓ Very small dimensions
- ✓ Long sensing ranges
- ✓ Small bending radii
- ✓ Can be cut on site
- ✓ Large selection of types
- ✓ Mechanically rugged sensing head



CABLE LENGTH	SLEEVE MATERIAL	TEMPERATURE RANGE	TECHNICAL DRAWING	PART REFERENCE
2 m	PE	-25 ... +70°C		LFP-1002-020
2 m	PE	-25 ... +70°C		LFP-1005-020
2 m	PE	-25 ... +70°C		LFP-1003-020
2 m	PE	-25 ... +70°C		LFP-1013-020
2 m	PE	-25 ... +70°C		LFP-1202-020
2 m	PE	-25 ... +70°C		LFP-2102-020

## OUTPUT

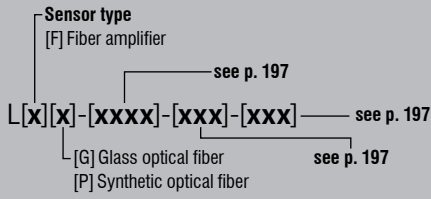

Reference key on page 197

## OPERATING PRINCIPLE



# FIBERS

## SYNTHETIC & GLASS

FAMILY	OPERATING PRINCIPLE	SENSING RANGE (mm)	FIBER MATERIAL	HOUSING SIZE (mm)
OPTICAL FIBERS	Through-beam	300	Plastic	M4
	Through-beam	400	Plastic	M4
	Through-beam	400	Plastic	M4
	Through-beam	500	Glass	M4
	Through-beam	500	Plastic	M4
	Through-beam	1,100	Plastic	M6



**KEY ADVANTAGES**

- ✓ Very small dimensions
- ✓ Long sensing ranges
- ✓ Small bending radii
- ✓ Can be cut on site
- ✓ Large selection of types
- ✓ Mechanically rugged sensing head



	CABLE LENGTH	SLEEVE MATERIAL	TEMPERATURE RANGE	TECHNICAL DRAWING	PART REFERENCE
	2 m	PE	-55 ... +105°C		LFP-2002-020-002
	2 m	PE	-25 ... +70°C		LFP-2002-020
	2 m	PE	-25 ... +70°C		LFP-2004-020
	0.5 m	Brass sleeve	-25 ... +160°C		LFG-3022-050
	2 m	PE	-25 ... +70°C		LFP-2202-020
	2 m	PE	-25 ... +70°C		LFP-2005-020



## APPLICATION

### **Distance sensor with IO-Link 1.1 profile detects presence of goods on shelf and measures available shelf space**

In a warehouse with an intelligent logistics concept, a robot arm must reliably detect whether goods are on the shelf and measure any available shelf space. With its ability to measure distances of up to 5,000 mm precisely, the C55 distance sensor is perfectly suited for this task. Using its IO-Link interface, it transmits the measurements directly to the control system as millimeter values in digital form, enabling optimal use of warehouse space.

## INDUSTRIES

Packaging, logistics, materials handling, woodworking industry, quality control, precision engineering, printed circuit board production



*Position control in furniture factory*



*Sensing and measuring shelf space*



*Packaging systems*



*Logistics*

# DISTANCE PHOTOELECTRIC SENSORS

## HIGH PRECISION AND DIRECT DIGITAL TRANSMISSION

As contactless measurement devices, photoelectric **Distance sensors** are suitable for numerous areas of application. C23 types use a triangulation method for accurate distance measurement at short range. For longer ranges, the optical time-of-flight (TOF) method is used by C55 types. Distance measurement is largely independent of target color or surface characteristics and repeatability is high.

### KEY ADVANTAGES

#### C23 distance-measuring sensors

- ✓ Two distance-measurement ranges: 20 ... 80 mm and 30 ... 200 mm
- ✓ Housing 20 × 34 × 12 mm
- ✓ High precision and repeatability
- ✓ Settable analog range for optimum distance measurement
- ✓ Enclosure rating IP67/IP69K



#### C55 distance-measuring sensors

- ✓ Distance measurement up to 5,000 mm
- ✓ Housing 50 × 50 × 23 mm
- ✓ High precision and repeatability
- ✓ Settable analog range for optimum distance measurement
- ✓ Enclosure rating IP67/IP69K, Ecolab approved
- ✓  IO-Link



### PRODUCT OVERVIEW

 IO-Link

SERIES Housing size mm	C23 □ 20 × 34 × 12	C55 □ 50 × 50 × 23
$s_n$ mm Short range	80/100/200	–
$s_n$ mm Medium range	–	5,000

### ACCESSORIES

Go to page 298 to see all the accessories

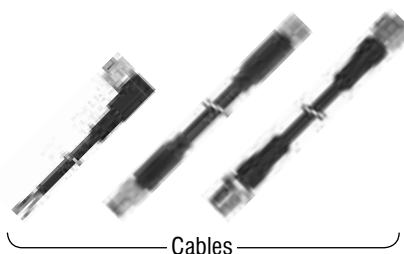

## COMMON FEATURES

**Supply Voltage range** 13 ... 30 VDC

## OUTPUT

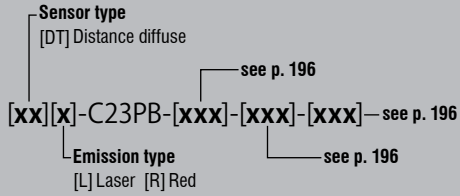

Reference key on page 196

## OPERATING PRINCIPLE



## ACCESSORIES

- A** Group A: M8 3-pin  
Sub-group: Field attachable connectors  
Sub-group: Distribution boxes
- B** Group B: M8 4-pin  
Sub-group: Field attachable connectors
- C** Group C: M12 4-pin  
Sub-group: Field attachable connectors  
Sub-group: Distribution boxes
- D** Group D: M12 AC/DC 3-pin
- E** Group E: Universal mounting brackets  
Sub-group: Mechanical stops
- F** Group F: Photoelectric mounting brackets
- G** Group G: Photoelectric reflectors
- H** Group H: Sensor tester

Go to page 298 for details

**CABLES**  
Cable lengths available:  
2 m, 5 m, 10 m  
other customised lengths possible

# CUBIC C23 C23 SERIES

FAMILY	OPERATING PRINCIPLE	SENSING RANGE (mm)	HOUSING SIZE (mm)	LIGHT SOURCE
CUBIC C23 – C23 SERIES		80	20 × 34 (C23)	LED, red 632 nm
		80	20 × 34 (C23)	LED, red 632 nm
		100	20 × 34 (C23)	⚠ Laser class 1, red 650 nm
		200	20 × 34 (C23)	LED, red 632 nm
		200	20 × 34 (C23)	LED, red 632 nm











CUBIC C23 – C23 SERIES



**KEY ADVANTAGES**

- ✓ Two distance measurement ranges: 20 ... 80 mm and 30 ... 200 mm
- ✓ Housing 20 × 34 × 12 mm
- ✓ High precision and repeatability
- ✓ Settable analog range for optimum distance measurement
- ✓ Enclosure rating IP67 / IP69K



	HOUSING MATERIAL	CABLE	CONNECTOR	IO-Link	SWITCHING FREQUENCY (Hz)	AMBIENT TEMPERATURE	DEGREE OF PROTECTION	PART REFERENCE	ACCESSORIES (SEE PAGE 178)
	ABS		 M8		1,000	-20 ... +60°C	IP67 / IP69K	<b>DTR-C23PB-TMS-139</b>	
	ABS		 M8		1,000	-20 ... +60°C	IP67 / IP69K	<b>DTR-C23PB-TMS-129</b>	
	ABS		 M8		1,000	-20 ... +60°C	IP67 / IP69K	<b>DTL-C23PB-TMS-139-501</b>	
	ABS		 M8		1,000	-20 ... +60°C	IP67 / IP69K	<b>DTR-C23PB-TLS-139</b>	
	ABS		 M8		1,000	-20 ... +60°C	IP67 / IP69K	<b>DTR-C23PB-TLS-129</b>	

## COMMON FEATURES

**Supply Voltage range** 18 ... 30 VDC

## OUTPUT

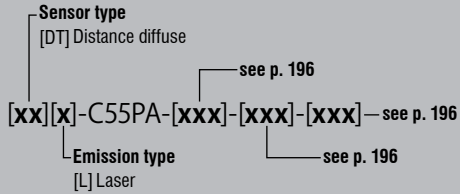

Reference key on page 196

## OPERATING PRINCIPLE



## ACCESSORIES

- A** Group A: M8 3-pin  
Sub-group: Field attachable connectors  
Sub-group: Distribution boxes
- B** Group B: M8 4-pin  
Sub-group: Field attachable connectors
- C** Group C: M12 4-pin  
Sub-group: Field attachable connectors  
Sub-group: Distribution boxes
- D** Group D: M12 AC/DC 3-pin
- E** Group E: Universal mounting brackets  
Sub-group: Mechanical stops
- F** Group F: Photoelectric mounting brackets
- G** Group G: Photoelectric reflectors
- H** Group H: Sensor tester

Go to page 298 for details



### CABLES

Cable lengths available:  
2 m, 5 m, 10 m  
other customised lengths possible

# CUBIC C55 C55 SERIES

FAMILY	OPERATING PRINCIPLE	SENSING RANGE (mm)	HOUSING SIZE (mm)	LIGHT SOURCE
CUBIC C55 – C55 SERIES		5,000	50 × 50 (C55)	⚠ Laser class 1, red 655 nm
		5,000	50 × 50 (C55)	⚠ Laser class 1, red 655 nm
		5,000	50 × 50 (C55)	⚠ Laser class 1, red 655 nm





CUBIC C55 – C55 SERIES



**KEY ADVANTAGES**

- ✓ Distance measurement up to 5,000 mm
- ✓ Housing 50 × 50 × 23 mm
- ✓ High precision and repeatability
- ✓ Settable analog range for optimum distance measurement
- ✓ Enclosure rating IP67 / IP69K, Ecolab approved
- ✓  IO-Link



	HOUSING MATERIAL	CABLE	CONNECTOR	 IO-Link	SWITCHING FREQUENCY (Hz)	AMBIENT TEMPERATURE	DEGREE OF PROTECTION	PART REFERENCE	ACCESSORIES (SEE PAGE 180)
	ABS		 M12		250	-40 ... +60°C	IP67 / IP69K	<b>DTL-C55PA-TMS-119-502</b>	<b>C F H</b>
	ABS		 M12		250	-40 ... +60°C	IP67 / IP69K	<b>DTL-C55PA-TMS-119-503</b>	<b>C F H</b>
	ABS		 M12	 IO-Link	500	-40 ... +60°C	IP67 / IP69K	<b>DTL-C55PA-TMS-407-505</b>	<b>C F H</b>



## APPLICATION

### **Contrast sensor checks label alignment and confirms presence of print markings during packaging operations**

During high-volume production of confectionery, sealed cartons of bagged candy travel by conveyor to a labeling station. A photoelectric contrast sensor, mounted beside the conveyor, checks the label alignment and confirms the presence of print markings as each carton leaves the labeling area. If a label is blank, illegible or wrongly positioned, the carton is diverted to a holding area for investigation.

## INDUSTRIES

Packaging, logistics, materials handling, food and beverage, filling machines, printing, quality control, sorting processes, tobacco industry, wood processing machines



*Color sorting on drinks conveyor*



*Detection of anodized products*



*Detection of marks on cartons*



*Print-mark detection on label machine*

# COLOR AND CONTRAST

## PHOTOELECTRIC SENSORS

### EXCELLENT RESOLUTION FOR SMALLEST VARIATIONS

**Color** sensors detect variations in target color, allowing color sorting or checking. Up to three separate outputs can be programmed using the teach-in function. **Contrast** sensors are ideal for detecting print marks in printing, labeling and packaging processes. With excellent resolution and five tolerance levels and five tolerance levels, detection is accurate, even when color or contrast differences are minimal.

#### KEY ADVANTAGES

- ✓ Rugged housing, 40 × 50 × 15 mm
- ✓ Connector adjustable at 0°, 45° and 90°
- ✓ 5 switching tolerance levels

#### Color sensors

- ✓ Three color-teach channels with independent outputs
- ✓ High positioning tolerance
- ✓ High switching frequency: up to 4 kHz

#### Contrast sensors

- ✓ Detection of very small print marks thanks to a narrow, collimated light spot
- ✓ RGB emission technology with best emission color automatically selected
- ✓ Excellent tolerance to target distance variations
- ✓ High switching frequency: up to 10 kHz



#### PRODUCT OVERVIEW

IO-Link		
<b>SERIES</b> Housing size mm	4050 Color □ 40 × 50 × 15	4050 Contrast □ 40 × 50 × 15
Diffuse (s <sub>n</sub> mm)	40	12

#### ACCESSORIES

Go to page 298 to see all the accessories



Cables

Mounting brackets

## COMMON FEATURES

**Supply Voltage range** 10 ... 30 VDC

## OUTPUT

Sensor type  
[T] Diffuse

[x][x][x]-4155-[xxx] — see p. 197

Connection  
[K] Cable [S] Connector

[F] Color sensor  
[K] Contrast sensor









Reference key on page 197

## OPERATING PRINCIPLE

 Diffuse (Color)

 Diffuse (Contrast)

## ACCESSORIES

-  **A** Group A: M8 3-pin  
Sub-group: Field attachable connectors  
Sub-group: Distribution boxes
-  **B** Group B: M8 4-pin  
Sub-group: Field attachable connectors
-  **C** Group C: M12 4-pin  
Sub-group: Field attachable connectors  
Sub-group: Distribution boxes
-  **D** Group D: M12 AC/DC 3-pin
-  **E** Group E: Universal mounting brackets  
Sub-group: Mechanical stops
-  **F** Group F: Photoelectric mounting brackets
-  **G** Group G: Photoelectric reflectors
-  **H** Group H: Sensor tester

Go to page 298 for details







### CABLES

Cable lengths available:  
2 m, 5 m, 10 m  
other customised lengths possible

# CUBIC 4050

# 4050 SERIES

FAMILY	OPERATING PRINCIPLE	SENSING RANGE (mm)	HOUSING SIZE (mm)	LIGHT SOURCE
CUBIC 4050 – 4050 SERIES		40	40 × 50	LED, white
		40	40 × 50	LED, white
		12	40 × 50	LED, RGB
		12	40 × 50	LED, RGB

CUBIC 4050 – 4050 SERIES



**KEY ADVANTAGES**

- ✓ Rugged housing, 40 × 50 × 15 mm
- ✓ Connector adjustable at 0°, 45° and 90°
- ✓ 5 switching tolerance levels

**Color sensors**

- ✓ 3 color teach channels with independent outputs
- ✓ High positioning tolerance
- ✓ High switching frequency: up to 4 kHz

**Contrast sensors**

- ✓ Detection of very small print marks thanks to a narrow, collimated light spot
- ✓ RGB emission technology with best emission color automatically selected
- ✓ Excellent tolerance to target distance variations
- ✓ High switching frequency: up to 10 kHz



	HOUSING MATERIAL	CABLE	CONNECTOR	IO-Link	SWITCHING FREQUENCY (Hz)	AMBIENT TEMPERATURE	DEGREE OF PROTECTION	PART REFERENCE	ACCESSORIES (SEE PAGE 184)
	PBTP		M12		4,000	-5 ... +55°C	IP67	<b>FTS-4155-301</b>	<b>C F H</b>
	PBTP		M12		4,000	-5 ... +55°C	IP67	<b>FTS-4155-303</b>	<b>C F H</b>
	PBTP		M12		10,000	-5 ... +55°C	IP67	<b>KTS-4155-407</b>	<b>C F H</b>
	PBTP	PVC			10,000	-5 ... +55°C	IP67	<b>KTK-4155-407</b>	<b>F H</b>

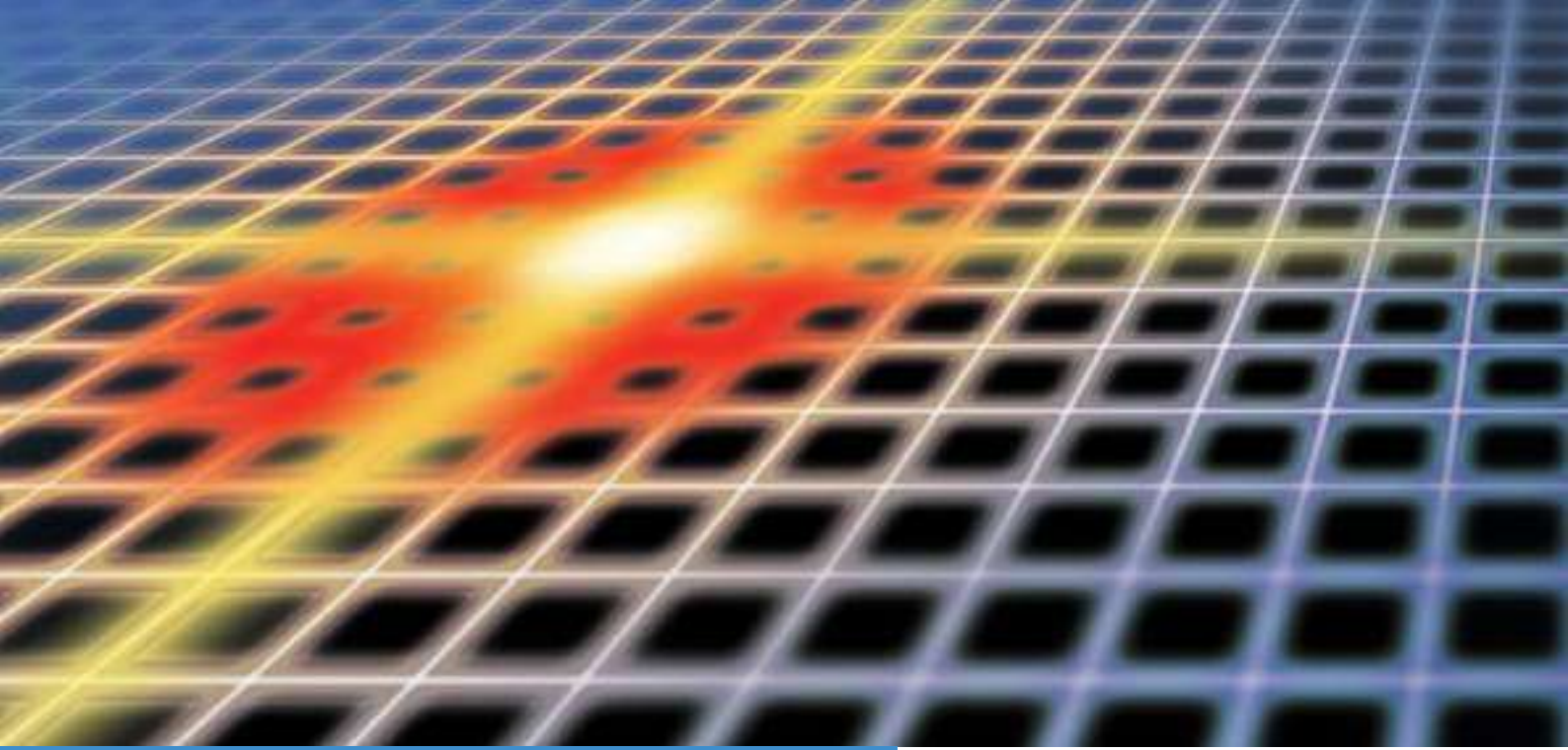

## APPLICATION

### **Infrared light grids detect misshapen and oversize carton packs after automated shrink-wrapping process**

During high-volume packaging operations, conveyors deliver stacked cartons to shrink-wrapping stations. At each station, a wrapping machine encloses a stack in heat-shrink film and an infrared oven shrinks the film to form a sealed pack of cartons. An infrared-light measurement grid, mounted beside the conveyor, checks the dimensions of each pack as it leaves the oven and signals a plant-wide control system if a wrapped pack is misshapen or oversize.

## INDUSTRIES

Packaging, logistics, materials handling, assembly, automation, laundry industry, small parts production, woodworking industry



*Counting of small objects*



*Carton measurement and sorting*



*Logistics systems*



*Packaging systems*

# LIGHT GRIDS PHOTOELECTRIC SENSORS

## FAST DETECTION, COUNTING AND MEASUREMENT

Contrinex's robust, plug-and-play **light grids** offer fast response times, reliable detection of the most varied objects and immunity to interference from ambient light. **DGI** detection grids can detect objects with diameters of 0.9, 2, 4, 8 or 25 mm, depending on type. **MGI** measurement grids can measure the dimensions of a detected object, and determine its position.

### KEY ADVANTAGES

- ✓ Plug-and-play installation
- ✓ Small installation space with cross-section: 40 × 20.5 mm

#### Detection grids

- ✓ Fast response time 0.8 ms ... 4.8 ms
- ✓ Ideal for detection and counting of even the smallest objects
- ✓ Resolution: 0.9 mm, 2 mm, 4 mm, 8 mm or 25 mm
- ✓ Detection height: up to 2,010 mm

#### Measurement grids

- ✓ Ideal for position and dimension control
- ✓ Center beam spacing: 5 mm or 12 mm
- ✓ Analog output 0–10 V or 4–20 mA
- ✓ Measurement height: up to 1,418 mm



### PRODUCT OVERVIEW

SERIES		DGI	MGI
Housing size mm		□ 40 × 20.5 × H	□ 40 × 20.5 × H
s <sub>n</sub> mm	Detection grids	8,000	–
	Measurement grids	–	4,000

### ACCESSORIES

Go to page 298 to see all the accessories

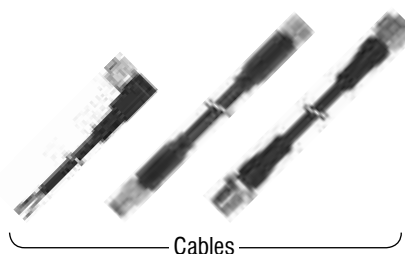

## COMMON FEATURES

Supply Voltage	24 VDC
Polarity	Push-Pull
Temperature range	-5 ... +50°C
Enclosure rating	IP65

## OUTPUT

DGI-**xx**A-**xxxx**-**xxx**-**xxx** — see p. 198

[##] Resolution in mm  
 see p. 198  
 Dimensions  
 [####] Beam height in mm

Reference key on page 198

## OPERATING PRINCIPLE

Detection grid

## ACCESSORIES

- A** Group A: M8 3-pin  
 Sub-group: Field attachable connectors  
 Sub-group: Distribution boxes
- B** Group B: M8 4-pin  
 Sub-group: Field attachable connectors
- C** Group C: M12 4-pin  
 Sub-group: Field attachable connectors  
 Sub-group: Distribution boxes
- D** Group D: M12 AC/DC 3-pin
- E** Group E: Universal mounting brackets  
 Sub-group: Mechanical stops
- F** Group F: Photoelectric mounting brackets
- G** Group G: Photoelectric reflectors
- H** Group H: Sensor tester

Go to page 298 for details

**CABLES**  
 Cable lengths available:  
 2 m, 5 m, 10 m  
 other customised lengths possible

# DETECTION GRIDS DGI SERIES

FAMILY	OPERATING PRINCIPLE	DETECTION RANGE (mm)	HOUSING SIZE (mm)	LIGHT SOURCE
DETECTION GRIDS – DGI SERIES		800	40 × 20.5 (Light Grid)	LED, infrared 880 nm
		800	40 × 20.5 (Light Grid)	LED, infrared 880 nm
		400	40 × 20.5 (Light Grid)	LED, infrared 880 nm
		400	40 × 20.5 (Light Grid)	LED, infrared 880 nm
		800	40 × 20.5 (Light Grid)	LED, infrared 880 nm
		800	40 × 20.5 (Light Grid)	LED, infrared 880 nm
		4,000	40 × 20.5 (Light Grid)	LED, infrared 880 nm
		4,000	40 × 20.5 (Light Grid)	LED, infrared 880 nm
		8,000	40 × 20.5 (Light Grid)	LED, infrared 880 nm
		8,000	40 × 20.5 (Light Grid)	LED, infrared 880 nm
		8,000	40 × 20.5 (Light Grid)	LED, infrared 880 nm



**KEY ADVANTAGES**

- ✓ Compact aluminum housing (40 × 20.5 mm × height)
- ✓ Resolution of 0.9 mm to 25 mm, capable of detecting even the smallest object
- ✓ Detection range up to 8,000 mm
- ✓ Beam height from 75 mm up to 2,010 mm
- ✓ Two push-pull outputs (PNP + NPN), Light-ON + Dark-ON
- ✓ Fast response time from 0.8 to 4.8 ms
- ✓ Potentiometer for fine adjustment on 0.9 mm and 2 mm resolution grids



	HOUSING MATERIAL	CABLE	CONNECTOR	RESOLUTION (mm)	LIGHT GRID HEIGHT (mm)	OUTPUT 1	OUTPUT 2	PART REFERENCE	ACCESSORIES (SEE PAGE 188)
	Aluminum		M12	2	100	Light-ON	Dark-ON	<b>DGI-02A-0075-PMS-107</b>	<b>C F</b>
	Aluminum		M12	4	100	Light-ON	Dark-ON	<b>DGI-04A-0075-NMS-107</b>	<b>C F</b>
	Aluminum		M12	0.9	100	Light-ON	Dark-ON	<b>DGI-01A-0075-PMS-107</b>	<b>C F</b>
	Aluminum		M12	0.9	180	Light-ON	Dark-ON	<b>DGI-01A-0155-PMS-107</b>	<b>C F</b>
	Aluminum		M12	2	180	Light-ON	Dark-ON	<b>DGI-02A-0155-PMS-107</b>	<b>C F</b>
	Aluminum		M12	4	180	Light-ON	Dark-ON	<b>DGI-04A-0155-NMS-107</b>	<b>C F</b>
	Aluminum		M12	8	212	Light-ON	Dark-ON	<b>DGI-08A-0190-NMS-107</b>	<b>C F</b>
	Aluminum		M12	8	500	Light-ON	Dark-ON	<b>DGI-08A-0480-NMS-107</b>	<b>C F</b>
	Aluminum		M12	25	500	Light-ON	Dark-ON	<b>DGI-25A-0480-NMS-107</b>	<b>C F</b>
	Aluminum		M12	25	980	Light-ON	Dark-ON	<b>DGI-25A-0960-NMS-107</b>	<b>C F</b>
	Aluminum		M12	25	2,036	Light-ON	Dark-ON	<b>DGI-25A-2010-NMS-107</b>	<b>C F</b>

## COMMON FEATURES

Supply Voltage	24 VDC
Polarity	Analog
Temperature range	-5 ... +50°C
Enclosure rating	IP65

## OUTPUT

MGI-[xx]A-[xxxx]-[xxx]-[xxx] — see p. 198

[##] Center beam spacing in mm  
see p. 198

Dimensions  
[###] Beam height in mm

Reference key on page 198

## OPERATING PRINCIPLE



## ACCESSORIES

- A** Group A: M8 3-pin  
Sub-group: Field attachable connectors  
Sub-group: Distribution boxes
- B** Group B: M8 4-pin  
Sub-group: Field attachable connectors
- C** Group C: M12 4-pin  
Sub-group: Field attachable connectors  
Sub-group: Distribution boxes
- D** Group D: M12 AC/DC 3-pin
- E** Group E: Universal mounting brackets  
Sub-group: Mechanical stops
- F** Group F: Photoelectric mounting brackets
- G** Group G: Photoelectric reflectors
- H** Group H: Sensor tester

Go to page 298 for details

**CABLES**  
Cable lengths available:  
2 m, 5 m, 10 m  
other customised lengths possible

# MEASUREMENT GRIDS MGI SERIES

FAMILY	OPERATING PRINCIPLE	SENSING RANGE (mm)	HOUSING SIZE (mm)	LIGHT SOURCE
MEASUREMENT GRIDS – MGI SERIES		4,000	40 × 20.5 (Light Grid)	LED, infrared 880 nm
		4,000	40 × 20.5 (Light Grid)	LED, infrared 880 nm
		4,000	40 × 20.5 (Light Grid)	LED, infrared 880 nm
		4,000	40 × 20.5 (Light Grid)	LED, infrared 880 nm
		4,000	40 × 20.5 (Light Grid)	LED, infrared 880 nm
		4,000	40 × 20.5 (Light Grid)	LED, infrared 880 nm

MEASUREMENT GRIDS – MGI SERIES



**KEY ADVANTAGES**

- ✓ Compact aluminum housing (40 × 20.5 mm × height)
- ✓ Center beam spacing 5 mm and 12 mm
- ✓ Measurement range up to 4,000 mm
- ✓ Beam height from 230 mm up to 1,420 mm
- ✓ Analog output 0–10 V or 4–20 mA
- ✓ Fast response time from 3 to 14 ms
- ✓ Four switching modes selectable through multi-switch



	HOUSING MATERIAL	CABLE	CONNECTOR	RESOLUTION (mm)	LIGHT GRID HEIGHT (mm)	OUTPUT 1	OUTPUT 2	PART REFERENCE	ACCESSORIES (SEE PAGE 190)
	Aluminum	0.3 m PUR	M12	6	260	4 ... 20 mA	0 ... 10 V	MGI-05A-0232-NMS-149	C F
	Aluminum	0.3 m PUR	M12	6	500	4 ... 20 mA	0 ... 10 V	MGI-05A-0472-NMS-149	C F
	Aluminum	0.3 m PUR	M12	6	980	4 ... 20 mA	0 ... 10 V	MGI-05A-0952-NMS-149	C F
	Aluminum	0.3 m PUR	M12	14	500	4 ... 20 mA	0 ... 10 V	MGI-12A-0458-NMS-149	C F
	Aluminum	0.3 m PUR	M12	14	980	4 ... 20 mA	0 ... 10 V	MGI-12A-0938-NMS-149	C F
	Aluminum	0.3 m PUR	M12	14	1,460	4 ... 20 mA	0 ... 10 V	MGI-12A-1418-NMS-149	C F



## APPLICATION

### Photoelectric fork sensor checks presence of plastic cap and eliminates downtime

During continuous production of fast-moving consumer goods, line stoppages are both costly and time consuming. After filling, sealing and capping, bottles of table sauces proceed for labelling and packaging; at this stage, the undetected absence of a plastic cap from an individual bottle requires manual intervention and potentially the rejection of an entire batch of production. A highly versatile photoelectric fork sensor, positioned directly over the conveyor, senses the presence of a cap on each bottle prior to labelling and triggers an alarm if a cap is missing. Contrinex fork light-barrier sensors with industry-standard IO-Link communication are ideal for this application, offering designers four discrete operating modes and switching frequencies up to 14,000 Hz. With a standard resolution of 0.3 mm (down to 0.1 mm in high-resolution mode) and fork openings from 10 mm to 120 mm, these robust, metal-cased sensors are well suited to both the task and the environment.

## INDUSTRIES

Robotics, packaging, materials handling, logistics, food and beverage



*Robotics*



*Beverage filling machines*



*Conveyor systems*



*Packaging systems*

# FORK SENSORS

## PHOTOELECTRIC SENSORS

### ROBUST SPACE-SAVING DESIGN OFFERS VERSATILITY AND SIMPLICITY

Contrinex fork light-barrier sensors offer a powerful combination of simplicity, multi-mode operation and compactness, with high-resolution and high-speed sensing as standard. Ideal for general position- and presence-sensing in industrial environments, these versatile, metal-cased devices allow four modes of operation – standard, high-resolution, power and high-speed – and the convenience of a push-pull output. Equipped with the industry-standard IO-Link protocol, they provide a choice of manual or remote set-up and adjustment, simplifying installation while saving time and money.

#### KEY ADVANTAGES

- ✓ High resolution: Ø 0.1–0.2 mm
- ✓ High frequency up to 14 kHz
- ✓ 4 sensor modes: Standard, High Resolution, Power, Speed
- ✓  IO-Link v1.1
- ✓ Sensitivity adjustment allowing detection of transparent objects
- ✓ Compact design accommodates photoelectric emitter and receiver in a single housing
- ✓ Push-pull output keeps inventory costs down while allowing exceptional flexibility
- ✓ Robust space-saving housing ensures precise alignment requiring no on-site adjustment



#### PRODUCT OVERVIEW

 IO-Link								
SERIES	U 10	U 20	U 30	U 40	U 50	U 80	U 11	U 12
Housing size mm	□ 25×45×10	□ 40×50×10	□ 50×60×10	□ 60×70×10	□ 70×80×10	□ 100×80×10	□ 120×80×10	□ 144×90×12
Through-beam (s <sub>n</sub> mm)	10	20	30	40	50	80	100	120

#### ACCESSORIES

Go to page 298 to see all the accessories

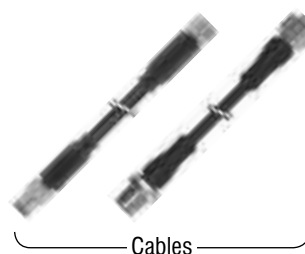

## COMMON FEATURES

Supply Voltage range	10 ... 30 VDC
Output	Light-ON/Dark-ON/IO-Link
Ambient temperature	-25 ... +60°C

## OUTPUT

**Housing size**  
 [# #] Fork opening in mm

**Emission type**  
 [I] Infrared [R] Red

LG[x]-U[xx]MA-[xxx]-[xxx] — see p. 196

Reference key on page 196

## OPERATING PRINCIPLE

Through-beam

## ACCESSORIES

- A** Group A: M8 3-pin  
 Sub-group: Field attachable connectors  
 Sub-group: Distribution boxes
- B** Group B: M8 4-pin
- C** Group C: M12 4-pin  
 Sub-group: Field attachable connectors  
 Sub-group: Distribution boxes
- D** Group D: M12 AC/DC 3-pin
- E** Group E: Universal mounting brackets  
 Sub-group: Mechanical stops
- F** Group F: Photoelectric mounting brackets
- G** Group G: Photoelectric reflectors
- H** Group H: Sensor tester

Go to page 298 for details

**CABLES**  
 Cable lengths available:  
 2 m, 5 m, 10 m  
 other customised lengths possible

# U-SHAPE FORK SENSORS LG SERIES

FAMILY	OPERATING PRINCIPLE	SENSING RANGE (mm)	FORK OPENING (mm)	LIGHT SOURCE
U-SHAPE FORK SENSORS – LG SERIES		10	10	LED, infrared 880 nm
		20	20	LED, red 660 nm
		30	30	LED, red 660 nm
		40	40	LED, red 660 nm
		50	50	LED, red 660 nm
		80	80	LED, red 660 nm
		100	100	LED, red 660 nm
		120	120	LED, red 660 nm

U-SHAPE FORK SENSORS – LG SERIES



**KEY ADVANTAGES**

- ✓ High resolution: Ø 0.1–0.2 mm
- ✓ High frequency up to 14 kHz
- ✓ Four sensor modes: Standard, High Resolution, Power, Speed
- ✓  IO-Link v1.1
- ✓ Sensitivity adjustment allowing detection of transparent objects
- ✓ Compact design accommodates photoelectric emitter and receiver in a single housing
- ✓ Push-pull output keeps inventory costs down while allowing exceptional flexibility
- ✓ Robust space-saving housing ensures precise alignment requiring no on-site adjustment



	HOUSING MATERIAL	CABLE	CONNECTOR	 IO-Link	SWITCHING FREQUENCY (Hz)	RESOLUTION (mm)	DEGREE OF PROTECTION	PART REFERENCE	ACCESSORIES (SEE PAGE 194)
	Die-cast zinc		 M8	 IO-Link	10,000	0.2	IP67	<b>LGI-U10MA-PMS-407</b>	
	Die-cast zinc		 M8	 IO-Link	5,000	0.3	IP67	<b>LGR-U20MA-PMS-407</b>	
	Die-cast zinc		 M8	 IO-Link	5,000	0.3	IP67	<b>LGR-U30MA-PMS-407</b>	
	Die-cast zinc		 M8	 IO-Link	5,000	0.3	IP67	<b>LGR-U40MA-PMS-407</b>	
	Die-cast zinc		 M8	 IO-Link	5,000	0.3	IP67	<b>LGR-U50MA-PMS-407</b>	
	Die-cast zinc		 M8	 IO-Link	5,000	0.3	IP67	<b>LGR-U80MA-PMS-407</b>	
	Die-cast zinc		 M8	 IO-Link	5,000	0.3	IP67	<b>LGR-U11MA-PMS-407</b>	
	Die-cast zinc		 M8	 IO-Link	5,000	0.5	IP67	<b>LGR-U12MA-PMS-407</b>	

# PHOTOELECTRIC SENSORS REFERENCE KEY

NEW DESIGNATION SINCE 2013

## LTR-C23PA-PMS-403 (-XXX)

### SENSOR TYPE

Diffuse	LT
Retro-reflex	LR
Through-beam	LL
Background suppression	LH
Distance diffuse	DT
Transparent retro-reflex	TR
Fork light barrier	LG

### EMISSION TYPE

Red	R
Laser	L
UV	U
Infrared	I

### HOUSING TYPE

Cubic	C
Cylindrical threaded	M
Cylindrical smooth	D
U-Shape	U

### HOUSING SIZE

Cubic 1# mm × 2# mm	12
Cubic 2# mm × 3# mm	23
Cubic 5# mm × 5# mm	55
Cylindrical 4 mm	04
Cylindrical 5 mm	05
Cylindrical 18 mm	18
U-Shape, fork opening in mm	##

### HOUSING MATERIAL

Plastic	P
Metal	M

### PERFORMANCE

Standard	A, B
----------	------

### ADJUSTMENT TYPE

No teach or potentiometer	N
Potentiometer	P
Teach button	T
Teach wire	W

### SPECIAL EXECUTIONS

#### OUTPUT

<b>4-wire devices, NPN</b>	
Light-ON + Dark-ON	01
Light-ON + stability alarm	0A
Dark-ON + stability alarm	0B
<b>4-wire devices, PNP</b>	
Light-ON + Dark-ON	03
Light-ON + stability alarm	0C
Dark-ON + stability alarm	0D
<b>3-wire devices, NPN</b>	
Light-ON	01
Dark-ON	02
<b>3-wire devices, PNP</b>	
Light-ON	03
Dark-ON	04
<b>Other</b>	
3- or 4-wire through-beam sensor (emitter)	00
Push-pull output	07
Analog	#9
Special	##
4-wire sensor	1
3-wire sensor	3
3-wire sensor with IO-Link	4
4-wire sensor with IO-Link	6

#### CONNECTION TYPE

Cable	K
Connector	S
Cable + connector	V

#### DETECTION DISTANCE

Short	S
Standard	M
Long	L
Extra long	X



# LTS-1180-303 (-XXX)

PHOTOELECTRIC SENSOR	L
COLOR SENSOR	F
CONTRAST SENSOR	K

## SENSOR TYPE

With analog output	A
For fibers / fiber	F
With background suppression	H
Through-beam sensor	L
Reflex sensor	R
Diffuse sensor	T
Accessories	X
Device with cable	K
Device with connector	S
Device with pigtail	V
Synthetic optical fiber	P
Glass optical fiber	G
Reflector (standard)	R
Reflector for UV light	U
Cutting tool	F
Mounting bracket	W

## SERIES

<b>Cylindrical devices</b>	
M12	1120
M12 laser	112#L
M18	1180
M18 laser	118#L
M18 with lateral light emission	1180W
<b>Rectangular devices</b>	
5 × 7 mm	0507
30 × 30 mm (high-performance)	3#30
30 × 30 mm (standard)	3#31
31 × 60 mm (standard)	3060
31 × 60 mm (teach-in)	3065
31 × 60 mm (teach-in & digital display)	3066
31 × 60 mm (blue light)	3360
40 × 50 mm	415#
<b>Synthetic optical fibers</b>	
Diffuse sensor	1###
Through-beam sensor	2###
Miniature / standard / coaxial	#0##
Flexible	#1##
Luminous (enhanced brightness)	#2##
<b>Glass optical fibers</b>	
Axial diffuse sensor	1###
Radial diffuse sensor	2###
Axial through-beam sensor	3###
Radial through-beam sensor	4###
Accessories	0###

## SPECIAL EXECUTIONS

### EXECUTION

3- or 4-wire through-beam sensor (emitter)	00
<b>4-wire devices, NPN, output</b>	
Light-ON + Dark-ON or switchable	01
Light-ON and excess gain	02
<b>4-wire devices, PNP, output</b>	
Light-ON + Dark-ON or switchable	03
Light-ON and excess gain	04
<b>3-wire devices, NPN, output</b>	
Light-ON	01
Dark-ON	02
<b>3-wire devices, PNP, output</b>	
Light-ON	03
Dark-ON	04

### DIMENSIONS

<b>Synthetic optical fibers</b>	
Length in dm (2 m)	020
Length in dm (5 m)	050
Length in dm (10 m)	100
<b>Glass optical fibers</b>	
Length in cm (0.25 m)	025
Length in cm (0.50 m)	050
Length in cm (1 m)	100
Length in cm (2 m)	200
<b>Accessories</b>	
General	###

4-wire through-beam sensor	0
4-wire basic device	1
3-wire through-beam sensor	2
3-wire basic device	3
With IO-Link	4

# PHOTOELECTRIC SENSORS REFERENCE KEY

## LIGHT GRIDS

### DGI-02A-0075-PMS-107

#### LIGHT GRID TYPE

Detection grid	DG
Measurement grid	MG

#### LIGHT SOURCE

Infrared	I
----------	---

#### RESOLUTION / CENTER BEAM SPACING

Resolution in mm (DGI)	##
Center beam spacing in mm (MGI)	##

#### SERIES

Standard	A
----------	---

#### DIMENSIONS

Beam height in mm	####
-------------------	------

#### OUTPUT

Analog	49
Push-Pull	07

#### NUMBER OF WIRES

4-wire	1
--------	---

#### CONNECTION TYPE

Connector	S
-----------	---

#### SENSING RANGE

Standard	M
----------	---

#### ADJUSTMENT TYPE

No potentiometer	N
Potentiometer	P



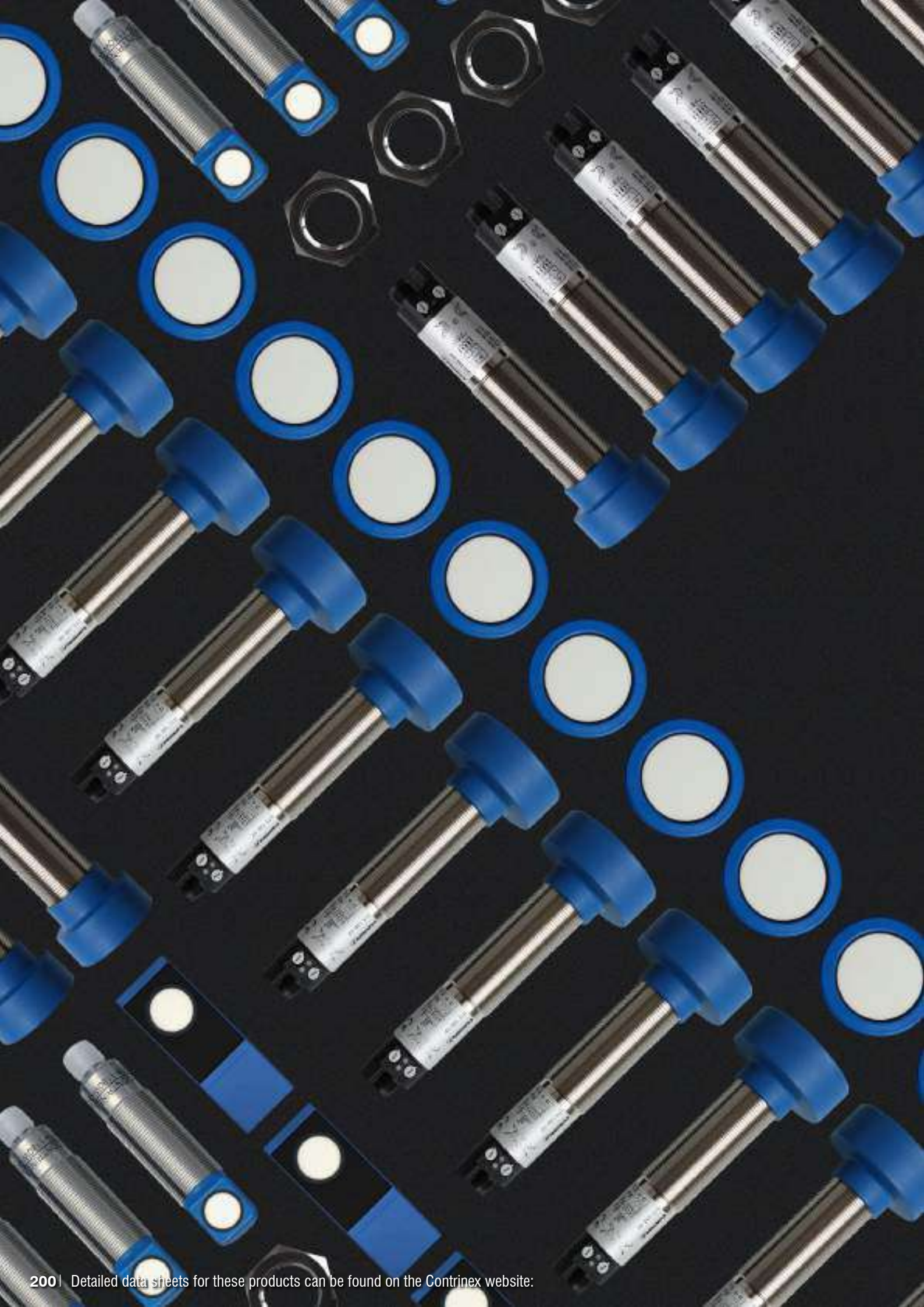



# ULTRASONIC SENSORS

## HIGHLIGHTS

- ✓ Detection independent of target material, color, shape or surface
- ✓ Ready-to-use cylindrical sensors with integral connector
- ✓ Easy adjustment by either potentiometer or teach-in
- ✓ Dual output sensors, including analog and digital
- ✓ High resolution analog output, current or voltage
- ✓ Normal length or short housings
- ✓ Reduced blind zone
- ✓ High excess gain, insensitive to dirt and ambient noise

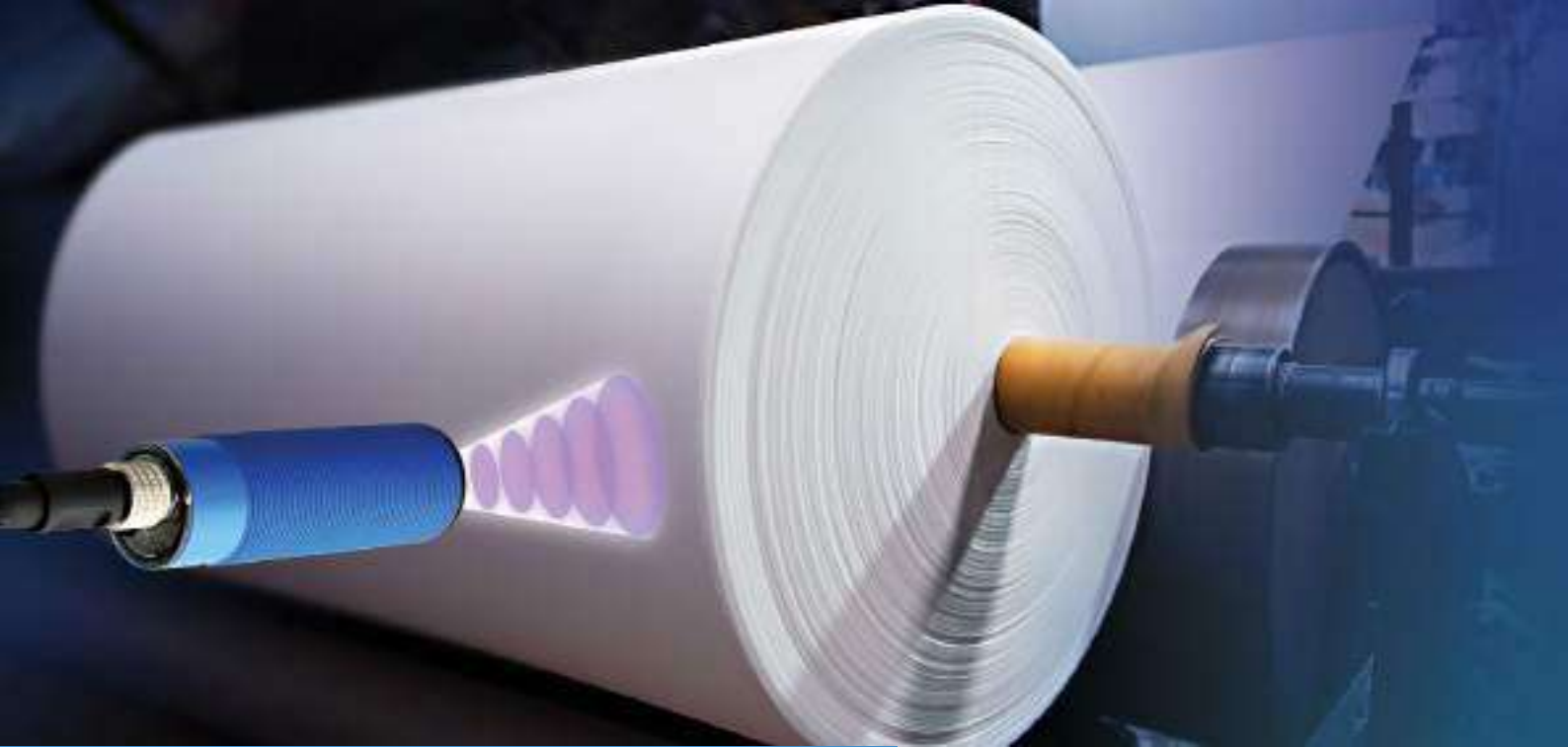

## INDUSTRIES

Packaging, logistics, materials handling, food and beverage, agriculture, filling machines

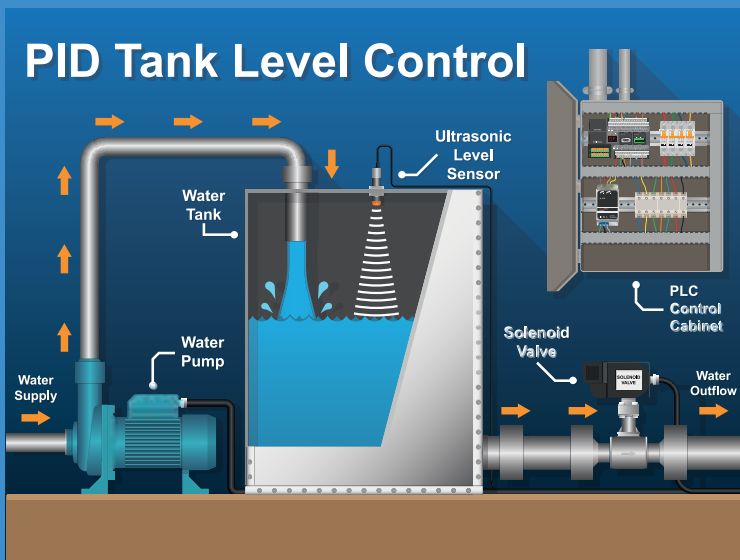

## APPLICATION

**Diffuse ultrasonic sensor provides continuous measurement of fill level for water-tank control system**

Within a water-supply system, the fill level of a tank must be monitored to ensure a continuous supply of water at a constant pressure. A cost-effective solution is to mount a single diffuse-type ultrasonic sensor in the cover of the tank, where it can provide the control system with constant measurement of the water level. Depending on this information, the control system switches the inlet pump on or off, adjusts its motor speed, and opens or closes the outlet valve.



*Level monitoring in plastic production*



*Liquid level sensing in food industry*



*Brewery production equipment*



*Logistics systems*

# ULTRASONIC SENSORS

## IDEAL FOR LIQUID OR GRANULAR TARGETS

**Ultrasonic** sensors provide reliable, non-contact detection of solid, liquid, granular or powdered materials in air. They emit a high-frequency acoustic signal in the direction of the target and evaluate the reflected signal. The target is detected and, simultaneously, its distance from the sensor can be calculated precisely from the signal's transit time. The target material may be transparent or colored and may have a polished or matt surface.

### KEY ADVANTAGES

- ✓ Precise control of position, distance, height and level
- ✓ Sensing ranges up to 6,000 mm
- ✓ Range setting and NO/NC configuration by teach button or wire
- ✓ Diffuse types with foreground and background suppression
- ✓ Reflex types with no blind zone
- ✓ Robust housings in food-grade stainless steel or plastic with integral M12 connector, IP67
- ✓ M18 in standard or short body
- ✓ M30 in standard body or with large head
- ✓ Various output types, including analog, voltage and current
- ✓ Crosstalk prevention through synchronization and multiplexing mode
- ✓ Insensitive to dirt and ambient noise
- ✓ Temperature range  $-20 \dots +70^{\circ}\text{C}$  ( $-4 \dots +158^{\circ}\text{F}$ )



### PRODUCT OVERVIEW

\*Metal or plastic housing    \*\*Plastic housing

SERIES Housing size mm		M18 short body*	M18 standard body*	M30 standard body*	M30 large head**
S <sub>n</sub> mm	Diffuse	300/1,200	900/2,000	2,500/3,500	6,000
	Reflex	300/1,200	900/2,000	–	–

### ACCESSORIES

Go to page 298 to see all the accessories

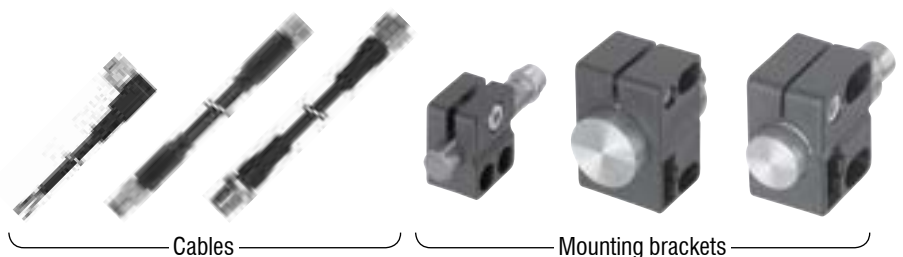

Cables

Mounting brackets

# ULTRASONIC SENSORS M18

## COMMON FEATURES

Supply Voltage range	15 ... 30 VDC
Output	PNP*

\* Other types available: NPN

## OUTPUT

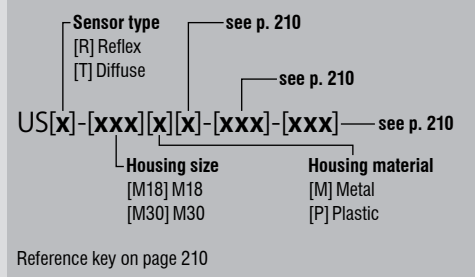

## OPERATING PRINCIPLE



## ACCESSORIES

**A** Group A: M8 3-pin  
Sub-group: Field attachable connectors  
Sub-group: Distribution boxes

**B** Group B: M8 4-pin  
Sub-group: Field attachable connectors

**C** Group C: M12 4-pin  
Sub-group: Field attachable connectors  
Sub-group: Distribution boxes

**D** Group D: M12 AC/DC 3-pin

**E** Group E: Universal mounting brackets  
Sub-group: Mechanical stops

**F** Group F: Photoelectric mounting brackets

**G** Group G: Photoelectric reflectors

**H** Group H: Sensor tester

Go to page 298 for details

**CABLES**  
Cable lengths available:  
2 m, 5 m, 10 m  
other customised lengths possible

# ULTRASONIC SMALL M18

FAMILY	OPERATING PRINCIPLE	OPERATING RANGE (mm)	HOUSING SIZE (mm)	PRODUCT RANGE
SMALL M18		300	M18	Short body
		1,200	M18	Short body
		300	M18	Short body
		1,200	M18	Short body
		300	M18	Short body
		1,200	M18	Short body
		300	M18	Short body
		1,200	M18	Short body
		900	M18	Standard body
		2,000	M18	Standard body
		900	M18	Standard body
		2,000	M18	Standard body
		900	M18	Standard body
		2,000	M18	Standard body
		900	M18	Standard body
		2,000	M18	Standard body
		900	M18	Standard body
		2,000	M18	Standard body
		900	M18	Standard body



KEY ADVANTAGES

- ✓ Precise control of position, distance, height and level
- ✓ Sensing ranges up to 6,000 mm
- ✓ Range setting and NO/NC configuration by teach button or wire
- ✓ Various output types, including analog, voltage and current
- ✓ Diffuse types with foreground and background suppression
- ✓ Reflex types with no blind zone
- ✓ Robust housings in food-grade stainless steel or plastic with integral M12 connector, IP67
- ✓ M18 in standard or short body
- ✓ M30 in standard body or with large head
- ✓ Crosstalk prevention through synchronization and multiplexing mode
- ✓ Insensitive to dirt and ambient noise
- ✓ Temperature range  $-20 \dots +70^{\circ}\text{C}$  ( $-4 \dots +158^{\circ}\text{F}$ )



	HOUSING MATERIAL	CONNECTOR	SWITCHING FREQUENCY (Hz)	OUTPUT 1	OUTPUT 2	OUTPUT 3	PART REFERENCE*	ACCESSORIES (SEE PAGE 204)
	PBTP	M12	8	NO (default)/NC	–	–	UST-M18PC-WSS-303	C E H
	PBTP	M12	5	NO (default)/NC	–	–	UST-M18PC-WMS-303	C E H
	PBTP	M12	8	NO (default)/NC	–	–	USR-M18PC-WSS-303	C E H
	PBTP	M12	3	NO (default)/NC	–	–	USR-M18PC-WMS-303	C E H
	Stainless steel V2A	M12	8	NO (default)/NC	–	–	UST-M18MC-WSS-303	C E H
	Stainless steel V2A	M12	5	NO (default)/NC	–	–	UST-M18MC-WMS-303	C E H
	Stainless steel V2A	M12	8	NO (default)/NC	–	–	USR-M18MC-WSS-303	C E H
	Stainless steel V2A	M12	3	NO (default)/NC	–	–	USR-M18MC-WMS-303	C E H
	PBTP	M12	4	NO (default)/NC	–	–	UST-M18PS-TMS-403	C E H
	PBTP	M12	2	NO (default)/NC	–	–	UST-M18PS-TLS-403	C E H
	PBTP	M12	4	NO (default)/NC	NO (default)/NC	–	UST-M18PS-TMS-603	C E H
	PBTP	M12	2	NO (default)/NC	NO (default)/NC	–	UST-M18PS-TLS-603	C E H
	PBTP	M12	4	NO (default)/NC	NO (default)/NC	4 ... 20 mA	UST-M18PS-TMS-839	E H
	PBTP	M12	2	NO (default)/NC	NO (default)/NC	4 ... 20 mA	UST-M18PS-TLS-839	E H
	PBTP	M12	4	NO (default)/NC	NO (default)/NC	0 ... 10 V	UST-M18PS-TMS-83A	E H
	PBTP	M12	2	NO (default)/NC	NO (default)/NC	0 ... 10 V	UST-M18PS-TLS-83A	E H
	PBTP	M12	4	NO (default)/NC	NO (default)/NC	SYNC/MUX	UST-M18PS-TMS-813	E H
	PBTP	M12	2	NO (default)/NC	NO (default)/NC	SYNC/MUX	UST-M18PS-TLS-813	E H
	PBTP	M12	4	NO (default)/NC	–	–	USR-M18PS-TMS-403	C E H
	PBTP	M12	2	NO (default)/NC	–	–	USR-M18PS-TLS-403	C E H
	Stainless steel V2A	M12	4	NO (default)/NC	–	–	UST-M18MS-TMS-403	C E H
	Stainless steel V2A	M12	2	NO (default)/NC	–	–	UST-M18MS-TLS-403	C E H
	Stainless steel V2A	M12	4	NO (default)/NC	NO (default)/NC	–	UST-M18MS-TMS-603	C E H

# ULTRASONIC SENSORS M18, M30

## COMMON FEATURES

Supply Voltage range	15 ... 30 VDC
Output	PNP*

\* Other types available: NPN

## OUTPUT

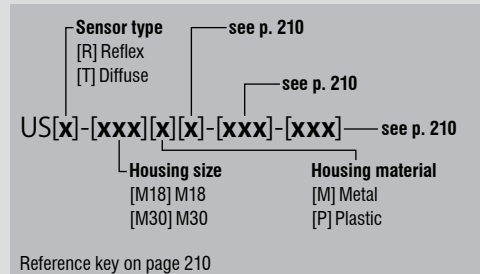

## OPERATING PRINCIPLE

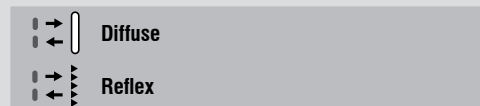













## ACCESSORIES

- A** Group A: M8 3-pin  
Sub-group: Field attachable connectors  
Sub-group: Distribution boxes
- B** Group B: M8 4-pin  
Sub-group: Field attachable connectors
- C** Group C: M12 4-pin  
Sub-group: Field attachable connectors  
Sub-group: Distribution boxes
- D** Group D: M12 AC/DC 3-pin
- E** Group E: Universal mounting brackets  
Sub-group: Mechanical stops
- F** Group F: Photoelectric mounting brackets
- G** Group G: Photoelectric reflectors
- H** Group H: Sensor tester

Go to page 298 for details

**CABLES**  
Cable lengths available:  
2 m, 5 m, 10 m  
other customised lengths possible

# ULTRASONIC SMALL M18 COMPACT M30

FAMILY	OPERATING PRINCIPLE	OPERATING RANGE (mm)	HOUSING SIZE (mm)	PRODUCT RANGE
SMALL M18		2,000	M18	Standard body
		900	M18	Standard body
		2,000	M18	Standard body
		900	M18	Standard body
		2,000	M18	Standard body
		900	M18	Standard body
		2,000	M18	Standard body
		900	M18	Standard body
		2,000	M18	Standard body
COMPACT M30		2,500	M30	Standard body
		2,500	M30	Standard body
		2,500	M30	Standard body
		2,500	M30	Standard body
		2,500	M30	Standard body
		3,500	M30	Standard body
		3,500	M30	Standard body
		3,500	M30	Standard body
		3,500	M30	Standard body
		3,500	M30	Standard body
		2,500	M30	Standard body
		2,500	M30	Standard body
		2,500	M30	Standard body
		2,500	M30	Standard body



KEY ADVANTAGES

- ✓ Precise control of position, distance, height and level
- ✓ Sensing ranges up to 6,000 mm
- ✓ Range setting and NO/NC configuration by teach button or wire
- ✓ Various output types, including analog, voltage and current
- ✓ Diffuse types with foreground and background suppression
- ✓ Reflex types with no blind zone
- ✓ Robust housings in food-grade stainless steel or plastic with integral M12 connector, IP67
- ✓ M18 in standard or short body
- ✓ M30 in standard body or with large head
- ✓ Crosstalk prevention through synchronization and multiplexing mode
- ✓ Insensitive to dirt and ambient noise
- ✓ Temperature range  $-20 \dots +70^{\circ}\text{C}$  ( $-4 \dots +158^{\circ}\text{F}$ )



	HOUSING MATERIAL	CONNECTOR	SWITCHING FREQUENCY (Hz)	OUTPUT 1	OUTPUT 2	OUTPUT 3	PART REFERENCE*	ACCESSORIES (SEE PAGE 206)
	Stainless steel V2A	M12	2	NO (default)/NC	NO (default)/NC	–	<b>UST-M18MS-TLS-603</b>	C E H
	Stainless steel V2A	M12	4	NO (default)/NC	NO (default)/NC	4 ... 20 mA	<b>UST-M18MS-TMS-839</b>	E H
	Stainless steel V2A	M12	2	NO (default)/NC	NO (default)/NC	4 ... 20 mA	<b>UST-M18MS-TLS-839</b>	E H
	Stainless steel V2A	M12	4	NO (default)/NC	NO (default)/NC	0 ... 10 V	<b>UST-M18MS-TMS-83A</b>	E H
	Stainless steel V2A	M12	2	NO (default)/NC	NO (default)/NC	0 ... 10 V	<b>UST-M18MS-TLS-83A</b>	E H
	Stainless steel V2A	M12	4	NO (default)/NC	NO (default)/NC	SYNC/MUX	<b>UST-M18MS-TMS-813</b>	E H
	Stainless steel V2A	M12	2	NO (default)/NC	NO (default)/NC	SYNC/MUX	<b>UST-M18MS-TLS-813</b>	E H
	Stainless steel V2A	M12	4	NO (default)/NC	–	–	<b>USR-M18MS-TMS-403</b>	C E H
	Stainless steel V2A	M12	2	NO (default)/NC	–	–	<b>USR-M18MS-TLS-403</b>	C E H
	PBTP	M12	2	NO (default)/NC	–	–	<b>UST-M30PS-TMS-403</b>	C E H
	PBTP	M12	2	NO (default)/NC	NO (default)/NC	–	<b>UST-M30PS-TMS-603</b>	C E H
	PBTP	M12	2	NO (default)/NC	NO (default)/NC	4 ... 20 mA	<b>UST-M30PS-TMS-839</b>	E H
	PBTP	M12	2	NO (default)/NC	NO (default)/NC	0 ... 10 V	<b>UST-M30PS-TMS-83A</b>	E H
	PBTP	M12	2	NO (default)/NC	NO (default)/NC	SYNC/MUX	<b>UST-M30PS-TMS-813</b>	E H
	PBTP	M12	2	NO (default)/NC	–	–	<b>UST-M30PS-TLS-403</b>	C E H
	PBTP	M12	2	NO (default)/NC	NO (default)/NC	–	<b>UST-M30PS-TLS-603</b>	C E H
	PBTP	M12	2	NO (default)/NC	NO (default)/NC	4 ... 20 mA	<b>UST-M30PS-TLS-839</b>	E H
	PBTP	M12	2	NO (default)/NC	NO (default)/NC	0 ... 10 V	<b>UST-M30PS-TLS-83A</b>	E H
	PBTP	M12	2	NO (default)/NC	NO (default)/NC	SYNC/MUX	<b>UST-M30PS-TLS-813</b>	E H
	Stainless steel V2A	M12	2	NO (default)/NC	–	–	<b>UST-M30MS-TMS-403</b>	C E H
	Stainless steel V2A	M12	2	NO (default)/NC	NO (default)/NC	–	<b>UST-M30MS-TMS-603</b>	C E H
	Stainless steel V2A	M12	2	NO (default)/NC	NO (default)/NC	4 ... 20 mA	<b>UST-M30MS-TMS-839</b>	E H

# ULTRASONIC SENSORS M30

## COMMON FEATURES

Supply Voltage range	15 ... 30 VDC
Output	PNP*

\* Other types available: NPN

## OUTPUT

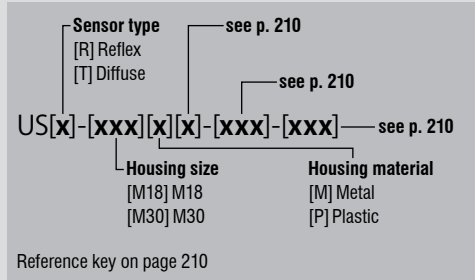

## OPERATING PRINCIPLE

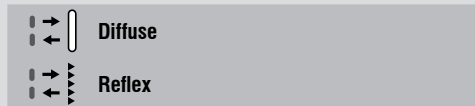

## ACCESSORIES

**A** Group A: M8 3-pin  
Sub-group: Field attachable connectors  
Sub-group: Distribution boxes

**B** Group B: M8 4-pin  
Sub-group: Field attachable connectors

**C** Group C: M12 4-pin  
Sub-group: Field attachable connectors  
Sub-group: Distribution boxes

**D** Group D: M12 AC/DC 3-pin

**E** Group E: Universal mounting brackets  
Sub-group: Mechanical stops

**F** Group F: Photoelectric mounting brackets

**G** Group G: Photoelectric reflectors

**H** Group H: Sensor tester

Go to page 298 for details

**CABLES**  
Cable lengths available:  
2 m, 5 m, 10 m  
other customised lengths possible

# ULTRASONIC COMPACT M30

FAMILY	OPERATING PRINCIPLE	OPERATING RANGE (mm)	HOUSING SIZE (mm)	PRODUCT RANGE
COMPACT M30		2,500	M30	Standard body
		2,500	M30	Standard body
		3,500	M30	Standard body
		3,500	M30	Standard body
		3,500	M30	Standard body
		3,500	M30	Standard body
		3,500	M30	Standard body
		3,500	M30	Standard body
		6,000	M30	Large head
		6,000	M30	Large head
		6,000	M30	Large head
		6,000	M30	Large head
		6,000	M30	Large head
		6,000	M30	Large head



KEY ADVANTAGES

- ✓ Precise control of position, distance, height and level
- ✓ Sensing ranges up to 6,000 mm
- ✓ Range setting and NO/NC configuration by teach button or wire
- ✓ Various output types, including analog, voltage and current
- ✓ Diffuse types with foreground and background suppression
- ✓ Reflex types with no blind zone
- ✓ Robust housings in food-grade stainless steel or plastic with integral M12 connector, IP67
- ✓ M18 in standard or short body
- ✓ M30 in standard body or with large head
- ✓ Crosstalk prevention through synchronization and multiplexing mode
- ✓ Insensitive to dirt and ambient noise
- ✓ Temperature range  $-20 \dots +70^{\circ}\text{C}$  ( $-4 \dots +158^{\circ}\text{F}$ )



	HOUSING MATERIAL	CONNECTOR	SWITCHING FREQUENCY (Hz)	OUTPUT 1	OUTPUT 2	OUTPUT 3	PART REFERENCE*	ACCESSORIES (SEE PAGE 208)
	Stainless steel V2A	M12	2	NO (default)/NC	NO (default)/NC	0 ... 10 V	<b>UST-M30MS-TMS-83A</b>	<b>E H</b>
	Stainless steel V2A	M12	2	NO (default)/NC	NO (default)/NC	SYNC/MUX	<b>UST-M30MS-TMS-813</b>	<b>E H</b>
	Stainless steel V2A	M12	2	NO (default)/NC	–	–	<b>UST-M30MS-TLS-403</b>	<b>C E H</b>
	Stainless steel V2A	M12	2	NO (default)/NC	NO (default)/NC	–	<b>UST-M30MS-TLS-603</b>	<b>C E H</b>
	Stainless steel V2A	M12	2	NO (default)/NC	NO (default)/NC	4 ... 20 mA	<b>UST-M30MS-TLS-839</b>	<b>E H</b>
	Stainless steel V2A	M12	2	NO (default)/NC	NO (default)/NC	0 ... 10 V	<b>UST-M30MS-TLS-83A</b>	<b>E H</b>
	Stainless steel V2A	M12	2	NO (default)/NC	NO (default)/NC	SYNC/MUX	<b>UST-M30MS-TLS-813</b>	<b>E H</b>
	PBTP	M12	1	NO (default)/NC	–	–	<b>UST-M30PO-TXS-403</b>	<b>C E H</b>
	PBTP	M12	1	NO (default)/NC	NO (default)/NC	–	<b>UST-M30PO-TXS-603</b>	<b>C E H</b>
	PBTP	M12	1	NO (default)/NC	NO (default)/NC	4 ... 20 mA	<b>UST-M30PO-TXS-839</b>	<b>E H</b>
	PBTP	M12	1	NO (default)/NC	NO (default)/NC	0 ... 10 V	<b>UST-M30PO-TXS-83A</b>	<b>E H</b>
	PBTP	M12	1	NO (default)/NC	NO (default)/NC	SYNC/MUX	<b>UST-M30PO-TXS-813</b>	<b>E H</b>

# ULTRASONIC SENSORS REFERENCE KEY

## UST-M18PS-TMS-403

### ULTRASONIC SENSOR US

### SENSOR TYPE

Reflex	R
Diffuse	T

### HOUSING TYPE

Cylindrical threaded	M
----------------------	---

### HOUSING SIZE

Ø18 mm	18
Ø30 mm	30

### HOUSING MATERIAL

Metal	M
Plastic	P

### HOUSING FORM

Short	C
Standard	S
Large head	O

### OUTPUT

NPN	01
PNP	03
4 ... 20 mA	09
0 ... 10 V	0A
NPN + SYNC/MUX	11
PNP + SYNC/MUX	13
NPN + 4 ... 20 mA	29
PNP + 4 ... 20 mA	39
NPN + 0 ... 10 V	2A
PNP + 0 ... 10 V	3A

Device 2 outputs	1
Device 1 output	3
Device 1 output with IO-Link	4
Device 2 outputs with IO-Link	6
Device 3 outputs	7
Device 3 outputs with IO-Link	8

### CONNECTION TYPE

Connector	S
-----------	---

### RANGE

Short	S
Standard	M
Long	L
Extra long	X

### ADJUSTMENT

Wire Teach	W
Button Teach	T





**CONTRINEX**

**CONTRINEX**

**CONTRINEX**



**CONTRINEX**

# SAFETINEX

## SAFETY LIGHT CURTAINS, SAFETY SENSORS AND RELAYS









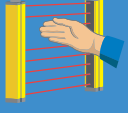

### LIGHT CURTAIN HIGHLIGHTS

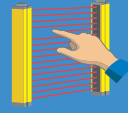

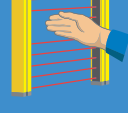
- ✓ Finger-, hand- and body-access resolutions
- ✓ Operating range from 0.25 ... 50 m
- ✓ Protective heights from 142 ... 1827 mm
- ✓ Category 2 or 4 according to EN/ISO 13849-1
- ✓ Certified TÜV, CE and UL
- ✓ IP65 and IP67
- ✓ Permanent autocontrol
- ✓ 2 channel selection
- ✓ Low power consumption

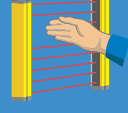
### NEW

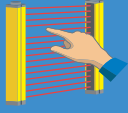
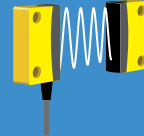
- ✓ Slim Type 2 safety light curtains
- ✓ Slim Type 4 safety light curtains with wireless configuration via Bluetooth®
- ✓ Magnetic and RFID safety sensors
- ✓ Signal filter

# PROGRAM OVERVIEW

PRODUCT RANGE		RESOLUTION		CATEGORY	FEATURES
LIGHT CURTAINS	BASIC SLIM	 30 mm		Cat. 2	<ul style="list-style-type: none"> <li>✓ No blind zone</li> <li>✓ Flexible mounting and connection</li> </ul>
	BASIC STANDARD	 14 mm		Cat. 4	<ul style="list-style-type: none"> <li>✓ Maximum operating range 3.5 m</li> <li>✓ Operating temperature <math>-35 \dots +60^{\circ}\text{C}</math></li> <li>✓ IP65, IP67</li> </ul>
		 30 mm		Cat. 4	<ul style="list-style-type: none"> <li>✓ Maximum operating range 12 m</li> <li>✓ Operating temperature <math>-35 \dots +60^{\circ}\text{C}</math></li> <li>✓ IP65, IP67</li> </ul>
				Cat. 2	<ul style="list-style-type: none"> <li>✓ Maximum operating range 12 m</li> <li>✓ Operating temperature <math>0 \dots +50^{\circ}\text{C}</math></li> <li>✓ IP65, IP67</li> </ul>
		 300 mm 400 mm 500 mm		Cat. 4	<ul style="list-style-type: none"> <li>✓ Maximum operating range 50 m</li> <li>✓ Operating temperature <math>-35 \dots +60^{\circ}\text{C}</math></li> <li>✓ IP65, IP67</li> </ul>
	EXTENDED SLIM	 30 mm		Cat. 4	<ul style="list-style-type: none"> <li>✓ No blind zone</li> <li>✓ Beam coding (3 channels), EDM, start and restart interlock configurable functions</li> <li>✓ Wireless configuration via Bluetooth®</li> </ul>
		 14 mm		Cat. 4	<ul style="list-style-type: none"> <li>✓ No blind zone</li> <li>✓ Beam coding (3 channels), EDM, start and restart interlock configurable functions</li> <li>✓ Wireless configuration via Bluetooth®</li> </ul>
	SAFETY SENSORS	MAGNETIC			up to Cat. 4
RFID			Cat. 4		<ul style="list-style-type: none"> <li>✓ RFID coded, ISO 14119 type 4</li> <li>✓ Cascadable up to 30 units</li> <li>✓ EDM and diagnostic function</li> </ul>

PRODUCT RANGE			FEATURES
<b>ACCESSORIES</b>	<b>DEVICE &amp; MIRROR COLUMNS</b>		<ul style="list-style-type: none"> <li>✓ Robust protective profile, attractive design</li> <li>✓ Special spring elements automatically reset position in case of mechanical impact</li> <li>✓ Complete assembly kit for both device and floor mounting included</li> <li>✓ Easy to mount: vertical and axial adjustments can be quickly completed in just a few steps</li> <li>✓ Single mirror or exchangeable and separately adjustable individual mirrors in accordance with EN 999</li> </ul>
	<b>MISCELLANEOUS</b>		<div style="text-align: center; margin-bottom: 10px;">  </div> <p><b>Relay</b></p> <ul style="list-style-type: none"> <li>✓ Performance Level (PL) e and category 4 according to EN/ISO 13849-1</li> <li>✓ Manual or automatic restart</li> <li>✓ Short response time</li> </ul> <p><b>Top/bottom mounting brackets</b></p> <ul style="list-style-type: none"> <li>✓ Synthetic mounting brackets</li> <li>✓ Pair of brackets supplied with each bracket</li> </ul> <p><b>Side/end mounting brackets</b></p> <ul style="list-style-type: none"> <li>✓ Metal mounting brackets</li> </ul> <p><b>Safety filter</b></p> <ul style="list-style-type: none"> <li>✓ Integrated RC filter for counter signal cut</li> <li>✓ Possibility to connect sender and receiver unit on same connector</li> </ul> <p><b>Laser alignment tool</b></p> <ul style="list-style-type: none"> <li>✓ Easily clippable onto Safetinx YBB and YCA devices</li> <li>✓ Range: up to 50 m</li> </ul>



# INTRODUCTION

## OPERATING PRINCIPLE OF LIGHT CURTAINS

Safetinx YBB, YBBS and YBES light curtains and YCA access control barriers operate with infrared beams. When the device detects a finger, a hand or a person entering the defined hazardous area, the protective equipment immediately stops the machine, or renders it harmless. When operating in manual restart mode, the reset button enabling the operator to restart the machine must be located outside the hazardous area. From there, the operator must have a full view of the hazardous area to make sure that nobody is in danger before restarting the machine.

Safetinx light curtains and access control barriers are designed to ensure protection of operators working in hazardous areas. A high reliability is achieved by implementing a fail-safe system: devices are thus permanently self-controlled. An internal failure deactivates the output signals, as would an intrusion into the protective field.

Safetinx light curtains and access control barriers are active optoelectronic protective devices (AOPDs) that include a sender and a receiver unit between which coded infrared beams are sequentially exchanged. The receiver unit is connected to a safety relay which transmits signals to the machine control system. Synchronization between the sender and receiver devices is performed optically, i.e. wired connection between the two units is not necessary.

Reception of all beams activates the two independently generated semiconductor outputs (OSSDs) of the receiver unit. The interruption of one or more beams deactivates the outputs within the response time of the AOPD. Any internal fault is detected by the device's permanent self-control function and has the same result as an intrusion into the protective field.

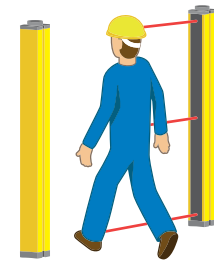

**Access control**

Beam separation  $\geq 300$  mm

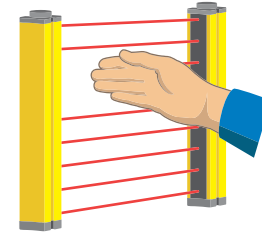

**Hand protection**

Beam resolution 30 mm

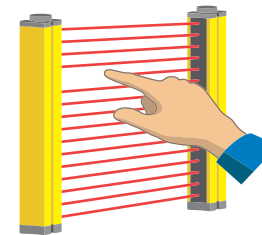

**Finger protection**



Beam resolution 14 mm

## EXTENDED SLIM – WIRELESS CONFIGURATION Bluetooth®



### Contrinex

Download now to monitor and configure your light curtains!



Download on the  App Store

GET IT ON  Google Play

# OPERATING PRINCIPLE OF SAFETY SENSORS

Safetinx YSM and YSR safety sensors comprise two parts: a main module and an actuator. They communicate with a contactless system of either magnetic or RFID coding. When the system detects that a guard door, hood or cover is open, the protective equipment immediately stops the machine, or renders it harmless.

YSM magnetic safety sensors use a coded magnet as an actuator and two reed contacts to open or close communication. Unlike light curtains, these sensors do not have OSSD outputs with self-check. They act simply as contactors that open or close depending on the presence or absence of a magnet. It is therefore necessary to apply power to the reed contacts.

YSR RFID safety sensors use an RFID tag as an actuator and a read/write module (RWM) as a contactor. These sensors have self-checking OSSD outputs, similar to light curtains. They are therefore connected in the same way as light curtains to a relay or controller. The RFID tag can be universally and randomly coded or can be teachable, which means the user pairs it with an RWM at first use to create a unique combination.



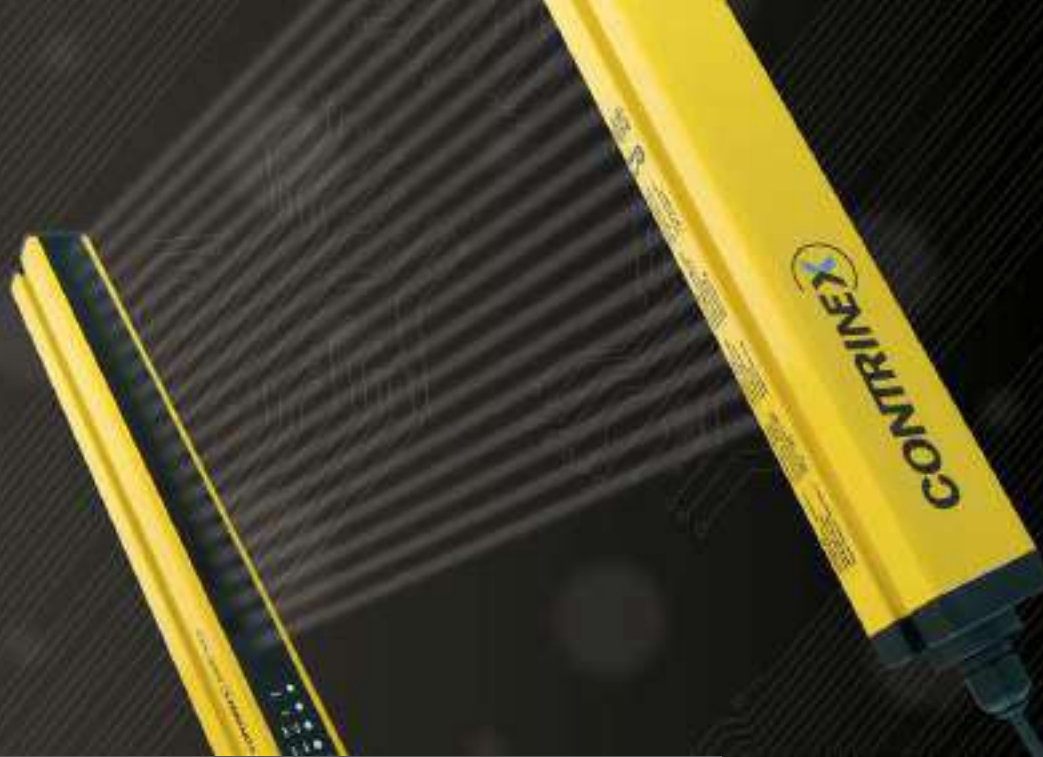

## APPLICATION

### Efficient and cost-effective protection with Safetinx Type 2

During semi-automated heat staking of assemblies for domestic white goods, manufacturers use light curtains to preserve operator safety without compromising production throughput. The active optoelectronic protective device (AOPD), mounted directly in front of each bench-mounted heat-press, prevents the press-head from descending if it detects any intrusion in the working area, halting the operating cycle immediately.

## INDUSTRIES

Automotive production and supply, machine tool, packaging, logistics, materials handling, textile, assembly, automation, robotics



*Automotive industry*



*Robotics*



*Machine tools*



*Textile industry*

# BASIC

## SAFETY LIGHT CURTAINS

EXCELLENT PRICE/PERFORMANCE RATIO

Light curtains are TÜV, CE and UL-certified according to IEC 61496-1 and -2 and ISO 13849-1. Protective heights range from 142 to 1,827 mm with permanent autocontrol and low power consumption. The aluminum housings are slim (26 × 26 mm) or standard (42 × 48 mm) and connection is via an integral 5-pin M12 connector or pigtail.

### KEY ADVANTAGES

#### FINGER TYPE 4

- ✓ Beam resolution 14 mm
- ✓ Highest protection category: Type 4
- ✓ Max. operating range 3.5 m
- ✓ Operating temperature  $-35 \dots +60^{\circ}\text{C}$  ( $-31 \dots +140^{\circ}\text{F}$ )
- ✓ Standard housing (42 × 48 mm) IP65, IP67

#### HAND TYPE 4 AND HAND TYPE 2

- ✓ Beam resolution 30 mm
- ✓ Two protection categories: Type 4 or Type 2
- ✓ Standard housing (42 × 48 mm): max. operating range 12 m, operating temperature  $-35 \dots +60^{\circ}\text{C}$  ( $-31 \dots +140^{\circ}\text{F}$ ), IP65, IP67
- ✓ Slim housing (26 × 26 mm): max operating range 8 m, no blind zone, operating temperature  $0 \dots +55^{\circ}\text{C}$  ( $+32 \dots +131^{\circ}\text{F}$ ), IP65

#### ACCESS TYPE 4

- ✓ Beam gap: 300, 400 or 500 mm (3 to 6 beams)
- ✓ Highest protection category: Type 4
- ✓ Max. operating range 1... 15 m or 10... 50 m (selectable)
- ✓ Operating temperature  $-35 \dots +60^{\circ}\text{C}$  ( $-31 \dots +140^{\circ}\text{F}$ )
- ✓ Standard housing (42 × 48 mm) IP65, IP67



### PRODUCT OVERVIEW

	SERIES Type	FINGER 4	HAND 4/2	ACCESS 4
PROTECTIVE HEIGHT (mm)	Basic Standard	142 ... 1,690	279 ... 1,827 (type 4) 150 ... 1,827 (type 2)	832 ... 1,532
	Basic Slim	–	170 ... 1,610	–

### ACCESSORIES

Go to pages 256 and 298 to see all the accessories



Relay



Mounting brackets

# SAFETY LIGHT CURTAINS BASIC STANDARD

## COMMON FEATURES

<b>Safety Level</b>	Cat. 2, PL c, Type 2
<b>Supply Voltage</b>	24 VDC
<b>Polarity</b>	PNP
<b>Resolution</b>	30 mm (hand)

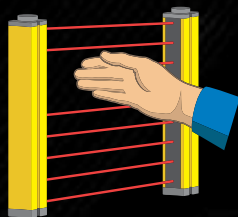

# HAND PROTECTION TYPE 2

## OUTPUT

YBB-30[x]2-[xxxx]-[xxxx]











**Protective height rounded (mm)**

**Module**  
[K] Kit (sender + receiver)  
[R] Receiver  
[S] Sender

**Connection type**  
[G012] M12 connector, 5 pins

Reference key on page 258

## ACCESSORIES

-  **Relay**  
See page 256
-  **Top/bottom mounting bracket**  
For YBB & YCA  
See page 256
-  **Sliding T-nuts for side mounting**  
See page 256
-  **Mounting bracket No. 5**  
For YBBS & YBES  
See page 256
-  **Mounting bracket No. 6**  
For YBBS & YBES  
See page 256
-  **Mounting bracket No. 7**  
For YBBS & YBES  
See page 256
-  **Safety filter**  
See page 257
-  **Laser alignment tool**  
See page 257
-  **Device columns**  
See page 254
-  **Mirror columns**  
See page 254

Go to page 298 for details

FAMILY	OPERATING RANGE (mm)	HOUSING SIZE (mm)
HAND PROTECTION – TYPE 2	0.25 ... 12 m	42 × 48 (standard)
	0.25 ... 12 m	42 × 48 (standard)
	0.25 ... 12 m	42 × 48 (standard)
	0.25 ... 12 m	42 × 48 (standard)
	0.25 ... 12 m	42 × 48 (standard)
	0.25 ... 12 m	42 × 48 (standard)
	0.25 ... 12 m	42 × 48 (standard)
	0.25 ... 12 m	42 × 48 (standard)
	0.25 ... 12 m	42 × 48 (standard)
	0.25 ... 12 m	42 × 48 (standard)
	0.25 ... 12 m	42 × 48 (standard)
	0.25 ... 12 m	42 × 48 (standard)
	0.25 ... 12 m	42 × 48 (standard)
	0.25 ... 12 m	42 × 48 (standard)
	0.25 ... 12 m	42 × 48 (standard)
	0.25 ... 12 m	42 × 48 (standard)
	0.25 ... 12 m	42 × 48 (standard)
	0.25 ... 12 m	42 × 48 (standard)
	0.25 ... 12 m	42 × 48 (standard)
	0.25 ... 12 m	42 × 48 (standard)



**KEY ADVANTAGES**

- ✓ Resolution: 30 mm
- ✓ Operating range: 0.25 ... 12 m
- ✓ Protective height: 150 ... 1,827 mm
- ✓ Category 2, PL c according to EN/ISO 13849-1
- ✓ Type 2 according to IEC 61496-1 and -2
- ✓ Certified TÜV, CE
- ✓ Housing profile 42 × 48 mm



	PROTECTIVE HEIGHT (mm)	TOTAL HEIGHT (mm)	SENDER WAVELENGTH (nm)	RESPONSE TIME (ms)	BEAM GAP (mm)	NUMBER OF BEAMS	AMBIENT TEMPERATURE	DEGREE OF PROTECTION	PART REFERENCE
	150	251	IR 850	14	16	9	0 ... +50°C	IP65 / IP67	YBB-30K2-0150-G012
	279	380	IR 850	18	16	17	0 ... +50°C	IP65 / IP67	YBB-30K2-0250-G012
	408	509	IR 850	22	16	25	0 ... +50°C	IP65 / IP67	YBB-30K2-0400-G012
	537	638	IR 850	26	16	33	0 ... +50°C	IP65 / IP67	YBB-30K2-0500-G012
	666	767	IR 850	30	16	41	0 ... +50°C	IP65 / IP67	YBB-30K2-0700-G012
	795	896	IR 850	34	16	49	0 ... +50°C	IP65 / IP67	YBB-30K2-0800-G012
	924	1,025	IR 850	38	16	57	0 ... +50°C	IP65 / IP67	YBB-30K2-0900-G012
	1,053	1,154	IR 850	42	16	65	0 ... +50°C	IP65 / IP67	YBB-30K2-1000-G012
	1,182	1,283	IR 850	46	16	73	0 ... +50°C	IP65 / IP67	YBB-30K2-1200-G012
	1,311	1,412	IR 850	50	16	81	0 ... +50°C	IP65 / IP67	YBB-30K2-1300-G012
	1,440	1,541	IR 850	54	16	89	0 ... +50°C	IP65 / IP67	YBB-30K2-1400-G012
	1,569	1,670	IR 850	58	16	97	0 ... +50°C	IP65 / IP67	YBB-30K2-1600-G012
	1,698	1,799	IR 850	62	16	105	0 ... +50°C	IP65 / IP67	YBB-30K2-1700-G012
	1,827	1,928	IR 850	66	16	113	0 ... +50°C	IP65 / IP67	YBB-30K2-1800-G012
	150	251	IR 850	14	16	9	0 ... +50°C	IP65 / IP67	YBB-30S2-0150-G012
	279	380	IR 850	18	16	17	0 ... +50°C	IP65 / IP67	YBB-30S2-0250-G012
	408	509	IR 850	22	16	25	0 ... +50°C	IP65 / IP67	YBB-30S2-0400-G012
	537	638	IR 850	26	16	33	0 ... +50°C	IP65 / IP67	YBB-30S2-0500-G012
	666	767	IR 850	30	16	41	0 ... +50°C	IP65 / IP67	YBB-30S2-0700-G012
	795	896	IR 850	34	16	49	0 ... +50°C	IP65 / IP67	YBB-30S2-0800-G012
	924	1,025	IR 850	38	16	57	0 ... +50°C	IP65 / IP67	YBB-30S2-0900-G012
	1,053	1,154	IR 850	42	16	65	0 ... +50°C	IP65 / IP67	YBB-30S2-1000-G012
	1,182	1,283	IR 850	46	16	73	0 ... +50°C	IP65 / IP67	YBB-30S2-1200-G012
	1,311	1,412	IR 850	50	16	81	0 ... +50°C	IP65 / IP67	YBB-30S2-1300-G012
	1,440	1,541	IR 850	54	16	89	0 ... +50°C	IP65 / IP67	YBB-30S2-1400-G012
	1,569	1,670	IR 850	58	16	97	0 ... +50°C	IP65 / IP67	YBB-30S2-1600-G012
	1,698	1,799	IR 850	62	16	105	0 ... +50°C	IP65 / IP67	YBB-30S2-1700-G012
	1,827	1,928	IR 850	66	16	113	0 ... +50°C	IP65 / IP67	YBB-30S2-1800-G012

# SAFETY LIGHT CURTAINS BASIC STANDARD

## COMMON FEATURES

<b>Safety Level</b>	Cat. 2, PL c, Type 2
<b>Supply Voltage</b>	24 VDC
<b>Polarity</b>	PNP
<b>Resolution</b>	30 mm (hand)

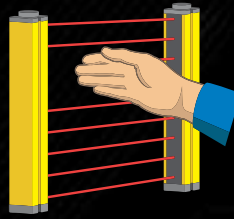

# HAND PROTECTION TYPE 2

## OUTPUT

YBB-30[x]2-[xxxx]-[xxxx]











**Protective height rounded (mm)**

**Module**  
[K] Kit (sender + receiver)  
[R] Receiver  
[S] Sender

**Connection type**  
[G012] M12 connector, 5 pins

Reference key on page 258

## ACCESSORIES

-  **Relay**  
See page 256
-  **Top/bottom mounting bracket**  
For YBB & YCA  
See page 256
-  **Sliding T-nuts for side mounting**  
See page 256
-  **Mounting bracket No. 5**  
For YBBS & YBES  
See page 256
-  **Mounting bracket No. 6**  
For YBBS & YBES  
See page 256
-  **Mounting bracket No. 7**  
For YBBS & YBES  
See page 256
-  **Safety filter**  
See page 257
-  **Laser alignment tool**  
See page 257
-  **Device columns**  
See page 254
-  **Mirror columns**  
See page 254

Go to page 298 for details

FAMILY	OPERATING RANGE (mm)	HOUSING SIZE (mm)
HAND PROTECTION – TYPE 2	0.25 ... 12 m	42 × 48 (standard)
	0.25 ... 12 m	42 × 48 (standard)
	0.25 ... 12 m	42 × 48 (standard)
	0.25 ... 12 m	42 × 48 (standard)
	0.25 ... 12 m	42 × 48 (standard)
	0.25 ... 12 m	42 × 48 (standard)
	0.25 ... 12 m	42 × 48 (standard)
	0.25 ... 12 m	42 × 48 (standard)
	0.25 ... 12 m	42 × 48 (standard)
	0.25 ... 12 m	42 × 48 (standard)
	0.25 ... 12 m	42 × 48 (standard)
	0.25 ... 12 m	42 × 48 (standard)
	0.25 ... 12 m	42 × 48 (standard)



**KEY ADVANTAGES**

- ✓ Resolution: 30 mm
- ✓ Operating range: 0.25 ... 12 m
- ✓ Protective height: 150 ... 1,827 mm
- ✓ Category 2, PL c according to EN/ISO 13849-1
- ✓ Type 2 according to IEC 61496-1 and -2
- ✓ Certified TÜV, CE
- ✓ Housing profile 42 × 48 mm



PROTECTIVE HEIGHT (mm)	TOTAL HEIGHT (mm)	SENDER WAVELENGTH (nm)	RESPONSE TIME (ms)	BEAM GAP (mm)	NUMBER OF BEAMS	AMBIENT TEMPERATURE	DEGREE OF PROTECTION	PART REFERENCE
150	251	IR 850	14	16	9	0 ... +50°C	IP65 / IP67	<b>YBB-30R2-0150-G012</b>
279	380	IR 850	18	16	17	0 ... +50°C	IP65 / IP67	<b>YBB-30R2-0250-G012</b>
408	509	IR 850	22	16	25	0 ... +50°C	IP65 / IP67	<b>YBB-30R2-0400-G012</b>
537	638	IR 850	26	16	33	0 ... +50°C	IP65 / IP67	<b>YBB-30R2-0500-G012</b>
666	767	IR 850	30	16	41	0 ... +50°C	IP65 / IP67	<b>YBB-30R2-0700-G012</b>
795	896	IR 850	34	16	49	0 ... +50°C	IP65 / IP67	<b>YBB-30R2-0800-G012</b>
924	1,025	IR 850	38	16	57	0 ... +50°C	IP65 / IP67	<b>YBB-30R2-0900-G012</b>
1,053	1,154	IR 850	42	16	65	0 ... +50°C	IP65 / IP67	<b>YBB-30R2-1000-G012</b>
1,182	1,283	IR 850	46	16	73	0 ... +50°C	IP65 / IP67	<b>YBB-30R2-1200-G012</b>
1,311	1,412	IR 850	50	16	81	0 ... +50°C	IP65 / IP67	<b>YBB-30R2-1300-G012</b>
1,440	1,541	IR 850	54	16	89	0 ... +50°C	IP65 / IP67	<b>YBB-30R2-1400-G012</b>
1,569	1,670	IR 850	58	16	97	0 ... +50°C	IP65 / IP67	<b>YBB-30R2-1600-G012</b>
1,698	1,799	IR 850	62	16	105	0 ... +50°C	IP65 / IP67	<b>YBB-30R2-1700-G012</b>
1,827	1,928	IR 850	66	16	113	0 ... +50°C	IP65 / IP67	<b>YBB-30R2-1800-G012</b>

# SAFETY LIGHT CURTAINS BASIC STANDARD

## COMMON FEATURES

<b>Safety Level</b>	Cat. 4, PL e, Type 4
<b>Supply Voltage</b>	24 VDC
<b>Polarity</b>	PNP
<b>Resolution</b>	30 mm (hand)

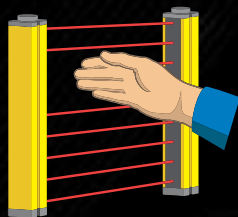

## HAND PROTECTION TYPE 4

## OUTPUT

YBB-30[x]4-[xxxx]-[xxxx]











**Protective height rounded (mm)**

**Module**  
[K] Kit (sender + receiver)  
[R] Receiver  
[S] Sender

**Connection type**  
[G012] M12 connector, 5 pins

Reference key on page 258

## ACCESSORIES

-  **Relay**  
See page 256
-  **Top/bottom mounting bracket**  
For YBB & YCA  
See page 256
-  **Sliding T-nuts for side mounting**  
See page 256
-  **Mounting bracket No. 5**  
For YBBS & YBES  
See page 256
-  **Mounting bracket No. 6**  
For YBBS & YBES  
See page 256
-  **Mounting bracket No. 7**  
For YBBS & YBES  
See page 256
-  **Safety filter**  
See page 257
-  **Laser alignment tool**  
See page 257
-  **Device columns**  
See page 254
-  **Mirror columns**  
See page 254

Go to page 298 for details

FAMILY	OPERATING RANGE (mm)	HOUSING SIZE (mm)
HAND PROTECTION – TYPE 4	0.25 ... 12 m	42 × 48 (standard)
	0.25 ... 12 m	42 × 48 (standard)
	0.25 ... 12 m	42 × 48 (standard)
	0.25 ... 12 m	42 × 48 (standard)
	0.25 ... 12 m	42 × 48 (standard)
	0.25 ... 12 m	42 × 48 (standard)
	0.25 ... 12 m	42 × 48 (standard)
	0.25 ... 12 m	42 × 48 (standard)
	0.25 ... 12 m	42 × 48 (standard)
	0.25 ... 12 m	42 × 48 (standard)
	0.25 ... 12 m	42 × 48 (standard)
	0.25 ... 12 m	42 × 48 (standard)
	0.25 ... 12 m	42 × 48 (standard)
	0.25 ... 12 m	42 × 48 (standard)
	0.25 ... 12 m	42 × 48 (standard)
	0.25 ... 12 m	42 × 48 (standard)
	0.25 ... 12 m	42 × 48 (standard)
	0.25 ... 12 m	42 × 48 (standard)
	0.25 ... 12 m	42 × 48 (standard)



**KEY ADVANTAGES**

- ✓ Resolution: 30 mm
- ✓ Operating range: 0.25 ... 12 m
- ✓ Protective height: 279 ... 1,827 mm
- ✓ Category 4, PL e according to EN/ISO 13849-1
- ✓ Type 4 according to IEC 61496-1 and -2
- ✓ Certified TÜV, CE and UL
- ✓ IP65, IP67 with operating temperatures as low as -35°C (-31°F)
- ✓ Housing profile 42 × 48 mm
- ✓ 2-channel selection
- ✓ Optical synchronization
- ✓ Permanent autocontrol



	PROTECTIVE HEIGHT (mm)	TOTAL HEIGHT (mm)	SENDER WAVELENGTH (nm)	RESPONSE TIME (ms)	BEAM GAP (mm)	NUMBER OF BEAMS	AMBIENT TEMPERATURE	DEGREE OF PROTECTION	PART REFERENCE
	279	380	IR 880	5.2	16	17	-35 ... +60°C	IP65 / IP67	YBB-30K4-0250-G012
	408	509	IR 880	6.8	16	25	-35 ... +60°C	IP65 / IP67	YBB-30K4-0400-G012
	537	638	IR 880	8.4	16	33	-35 ... +60°C	IP65 / IP67	YBB-30K4-0500-G012
	666	767	IR 880	10	16	41	-35 ... +60°C	IP65 / IP67	YBB-30K4-0700-G012
	795	896	IR 880	11.6	16	49	-35 ... +60°C	IP65 / IP67	YBB-30K4-0800-G012
	924	1,025	IR 880	13.2	16	57	-35 ... +60°C	IP65 / IP67	YBB-30K4-0900-G012
	1,053	1,154	IR 880	14.8	16	65	-35 ... +60°C	IP65 / IP67	YBB-30K4-1000-G012
	1,182	1,283	IR 880	16.4	16	73	-35 ... +60°C	IP65 / IP67	YBB-30K4-1200-G012
	1,311	1,412	IR 880	18	16	81	-35 ... +60°C	IP65 / IP67	YBB-30K4-1300-G012
	1,440	1,541	IR 880	19.6	16	89	-35 ... +60°C	IP65 / IP67	YBB-30K4-1400-G012
	1,569	1,670	IR 880	21.2	16	97	-35 ... +60°C	IP65 / IP67	YBB-30K4-1600-G012
	1,698	1,799	IR 880	22.8	16	105	-35 ... +60°C	IP65 / IP67	YBB-30K4-1700-G012
	1,827	1,928	IR 880	24.4	16	113	-35 ... +60°C	IP65 / IP67	YBB-30K4-1800-G012
	279	380	IR 880	5.2	16	17	-35 ... +60°C	IP65 / IP67	YBB-30S4-0250-G012
	408	509	IR 880	6.8	16	25	-35 ... +60°C	IP65 / IP67	YBB-30S4-0400-G012
	537	638	IR 880	8.4	16	33	-35 ... +60°C	IP65 / IP67	YBB-30S4-0500-G012
	666	767	IR 880	10	16	41	-35 ... +60°C	IP65 / IP67	YBB-30S4-0700-G012
	795	896	IR 880	11.6	16	49	-35 ... +60°C	IP65 / IP67	YBB-30S4-0800-G012
	924	1,025	IR 880	13.2	16	57	-35 ... +60°C	IP65 / IP67	YBB-30S4-0900-G012
	1,053	1,154	IR 880	14.8	16	65	-35 ... +60°C	IP65 / IP67	YBB-30S4-1000-G012
	1,182	1,283	IR 880	16.4	16	73	-35 ... +60°C	IP65 / IP67	YBB-30S4-1200-G012
	1,311	1,412	IR 880	18	16	81	-35 ... +60°C	IP65 / IP67	YBB-30S4-1300-G012
	1,440	1,541	IR 880	19.6	16	89	-35 ... +60°C	IP65 / IP67	YBB-30S4-1400-G012
	1,569	1,670	IR 880	21.2	16	97	-35 ... +60°C	IP65 / IP67	YBB-30S4-1600-G012
	1,698	1,799	IR 880	22.8	16	105	-35 ... +60°C	IP65 / IP67	YBB-30S4-1700-G012
	1,827	1,928	IR 880	24.4	16	113	-35 ... +60°C	IP65 / IP67	YBB-30S4-1800-G012
	279	380	IR 880	5.2	16	17	-35 ... +60°C	IP65 / IP67	YBB-30R4-0250-G012
	408	509	IR 880	6.8	16	25	-35 ... +60°C	IP65 / IP67	YBB-30R4-0400-G012

# SAFETY LIGHT CURTAINS BASIC STANDARD

## COMMON FEATURES

<b>Safety Level</b>	Cat. 4, PL e, Type 4
<b>Supply Voltage</b>	24 VDC
<b>Polarity</b>	PNP
<b>Resolution</b>	30 mm (hand)

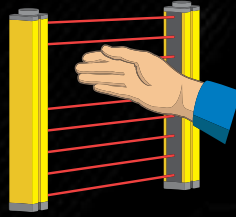

## HAND PROTECTION TYPE 4

## OUTPUT

YBB-30[x]4-[xxxx]-[xxxx]











**Protective height rounded (mm)**

**Module**  
[K] Kit (sender + receiver)  
[R] Receiver  
[S] Sender

**Connection type**  
[G012] M12 connector, 5 pins

Reference key on page 258

## ACCESSORIES

-  **Relay**  
See page 256
-  **Top/bottom mounting bracket**  
For YBB & YCA  
See page 256
-  **Sliding T-nuts for side mounting**  
See page 256
-  **Mounting bracket No. 5**  
For YBBS & YBES  
See page 256
-  **Mounting bracket No. 6**  
For YBBS & YBES  
See page 256
-  **Mounting bracket No. 7**  
For YBBS & YBES  
See page 256
-  **Safety filter**  
See page 257
-  **Laser alignment tool**  
See page 257
-  **Device columns**  
See page 254
-  **Mirror columns**  
See page 254

Go to page 298 for details

FAMILY	OPERATING RANGE (mm)	HOUSING SIZE (mm)
HAND PROTECTION – TYPE 4	0.25 ... 12 m	42 × 48 (standard)
	0.25 ... 12 m	42 × 48 (standard)
	0.25 ... 12 m	42 × 48 (standard)
	0.25 ... 12 m	42 × 48 (standard)
	0.25 ... 12 m	42 × 48 (standard)
	0.25 ... 12 m	42 × 48 (standard)
	0.25 ... 12 m	42 × 48 (standard)
	0.25 ... 12 m	42 × 48 (standard)
	0.25 ... 12 m	42 × 48 (standard)
	0.25 ... 12 m	42 × 48 (standard)



**KEY ADVANTAGES**

- ✓ Resolution: 30 mm
- ✓ Operating range: 0.25 ... 12 m
- ✓ Protective height: 279 ... 1,827 mm
- ✓ Category 4, PL e according to EN/ISO 13849-1
- ✓ Type 4 according to IEC 61496-1 and -2
- ✓ Certified TÜV, CE and UL
- ✓ IP65, IP67 with operating temperatures as low as -35°C (-31°F)
- ✓ Housing profile 42 × 48 mm
- ✓ 2-channel selection
- ✓ Optical synchronization
- ✓ Permanent autocontrol



PROTECTIVE HEIGHT (mm)	TOTAL HEIGHT (mm)	SENDER WAVELENGTH (nm)	RESPONSE TIME (ms)	BEAM GAP (mm)	NUMBER OF BEAMS	AMBIENT TEMPERATURE	DEGREE OF PROTECTION	PART REFERENCE
537	638	IR 880	8.4	16	33	-35 ... +60°C	IP65 / IP67	<b>YBB-30R4-0500-G012</b>
666	767	IR 880	10	16	41	-35 ... +60°C	IP65 / IP67	<b>YBB-30R4-0700-G012</b>
795	896	IR 880	11.6	16	49	-35 ... +60°C	IP65 / IP67	<b>YBB-30R4-0800-G012</b>
924	1,025	IR 880	13.2	16	57	-35 ... +60°C	IP65 / IP67	<b>YBB-30R4-0900-G012</b>
1,053	1,154	IR 880	14.8	16	65	-35 ... +60°C	IP65 / IP67	<b>YBB-30R4-1000-G012</b>
1,182	1,283	IR 880	16.4	16	73	-35 ... +60°C	IP65 / IP67	<b>YBB-30R4-1200-G012</b>
1,311	1,412	IR 880	18	16	81	-35 ... +60°C	IP65 / IP67	<b>YBB-30R4-1300-G012</b>
1,440	1,541	IR 880	19.6	16	89	-35 ... +60°C	IP65 / IP67	<b>YBB-30R4-1400-G012</b>
1,569	1,670	IR 880	21.2	16	97	-35 ... +60°C	IP65 / IP67	<b>YBB-30R4-1600-G012</b>
1,698	1,799	IR 880	22.8	16	105	-35 ... +60°C	IP65 / IP67	<b>YBB-30R4-1700-G012</b>
1,827	1,928	IR 880	24.4	16	113	-35 ... +60°C	IP65 / IP67	<b>YBB-30R4-1800-G012</b>

# SAFETY LIGHT CURTAINS BASIC STANDARD

## COMMON FEATURES

<b>Safety Level</b>	Cat. 4, PL e, Type 4
<b>Supply Voltage</b>	24 VDC
<b>Polarity</b>	PNP
<b>Resolution</b>	14 mm (finger)

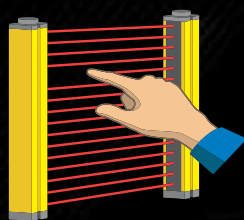

# FINGER PROTECTION TYPE 4

## OUTPUT

Protective height rounded (mm)











YBB-14[x]4-[xxxx]-[xxxx]

Module  
[K] Kit (sender + receiver)  
[R] Receiver  
[S] Sender

Connection type  
[G012] M12 connector, 5 pins

Reference key on page 258

## ACCESSORIES

-  **Relay**  
See page 256
-  **Top/bottom mounting bracket**  
For YBB & YCA  
See page 256
-  **Sliding T-nuts for side mounting**  
See page 256
-  **Mounting bracket No. 5**  
For YBBS & YBES  
See page 256
-  **Mounting bracket No. 6**  
For YBBS & YBES  
See page 256
-  **Mounting bracket No. 7**  
For YBBS & YBES  
See page 256
-  **Safety filter**  
See page 257
-  **Laser alignment tool**  
See page 257
-  **Device columns**  
See page 254
-  **Mirror columns**  
See page 254

Go to page 298 for details

FAMILY	OPERATING RANGE (mm)	HOUSING SIZE (mm)
FINGER PROTECTION – TYPE 4	0.25 ... 3.5 m	42 × 48 (standard)
	0.25 ... 3.5 m	42 × 48 (standard)
	0.25 ... 3.5 m	42 × 48 (standard)
	0.25 ... 3.5 m	42 × 48 (standard)
	0.25 ... 3.5 m	42 × 48 (standard)
	0.25 ... 3.5 m	42 × 48 (standard)
	0.25 ... 3.5 m	42 × 48 (standard)
	0.25 ... 3.5 m	42 × 48 (standard)
	0.25 ... 3.5 m	42 × 48 (standard)
	0.25 ... 3.5 m	42 × 48 (standard)
	0.25 ... 3.5 m	42 × 48 (standard)
	0.25 ... 3.5 m	42 × 48 (standard)
	0.25 ... 3.5 m	42 × 48 (standard)
	0.25 ... 3.5 m	42 × 48 (standard)
	0.25 ... 3.5 m	42 × 48 (standard)
	0.25 ... 3.5 m	42 × 48 (standard)
	0.25 ... 3.5 m	42 × 48 (standard)
	0.25 ... 3.5 m	42 × 48 (standard)
	0.25 ... 3.5 m	42 × 48 (standard)
	0.25 ... 3.5 m	42 × 48 (standard)



**KEY ADVANTAGES**

- ✓ Resolution: 14 mm
- ✓ Operating range: 0.25 ... 3.5 m
- ✓ Protective height: 142 ... 1,690 mm
- ✓ Category 4, PL e according to EN/ISO 13849-1
- ✓ Type 4 according to IEC 61496-1 and -2
- ✓ Certified TÜV, CE and UL
- ✓ IP65, IP67 with operating temperatures as low as -35°C (-31°F)
- ✓ Housing profile 42 × 48 mm
- ✓ 2-channel selection
- ✓ Optical synchronization
- ✓ Permanent autocontrol



	PROTECTIVE HEIGHT (mm)	TOTAL HEIGHT (mm)	SENDER WAVELENGTH (nm)	RESPONSE TIME (ms)	BEAM GAP (mm)	NUMBER OF BEAMS	AMBIENT TEMPERATURE	DEGREE OF PROTECTION	PART REFERENCE
	142	251	IR 950	5.2	8	17	-35 ... +60°C	IP65 / IP67	YBB-14K4-0150-G012
	271	380	IR 950	8.4	8	33	-35 ... +60°C	IP65 / IP67	YBB-14K4-0250-G012
	400	509	IR 950	11.6	8	49	-35 ... +60°C	IP65 / IP67	YBB-14K4-0400-G012
	529	638	IR 950	14.8	8	65	-35 ... +60°C	IP65 / IP67	YBB-14K4-0500-G012
	658	737	IR 950	18	8	81	-35 ... +60°C	IP65 / IP67	YBB-14K4-0700-G012
	787	896	IR 950	21.2	8	97	-35 ... +60°C	IP65 / IP67	YBB-14K4-0800-G012
	916	1,025	IR 950	24.4	8	113	-35 ... +60°C	IP65 / IP67	YBB-14K4-0900-G012
	1,045	1,154	IR 950	27.6	8	129	-35 ... +60°C	IP65 / IP67	YBB-14K4-1000-G012
	1,174	1,283	IR 950	30.8	8	145	-35 ... +60°C	IP65 / IP67	YBB-14K4-1200-G012
	1,303	1,412	IR 950	34	8	161	-35 ... +60°C	IP65 / IP67	YBB-14K4-1300-G012
	1,432	1,541	IR 950	37.2	8	177	-35 ... +60°C	IP65 / IP67	YBB-14K4-1400-G012
	1,561	1,670	IR 950	40.4	8	193	-35 ... +60°C	IP65 / IP67	YBB-14K4-1600-G012
	1,690	1,799	IR 950	43.6	8	209	-35 ... +60°C	IP65 / IP67	YBB-14K4-1700-G012
	142	251	IR 950	5.2	8	17	-35 ... +60°C	IP65 / IP67	YBB-14S4-0150-G012
	271	380	IR 950	8.4	8	33	-35 ... +60°C	IP65 / IP67	YBB-14S4-0250-G012
	400	509	IR 950	11.6	8	49	-35 ... +60°C	IP65 / IP67	YBB-14S4-0400-G012
	529	638	IR 950	14.8	8	65	-35 ... +60°C	IP65 / IP67	YBB-14S4-0500-G012
	658	737	IR 950	18	8	81	-35 ... +60°C	IP65 / IP67	YBB-14S4-0700-G012
	787	896	IR 950	21.2	8	97	-35 ... +60°C	IP65 / IP67	YBB-14S4-0800-G012
	916	1,025	IR 950	24.4	8	113	-35 ... +60°C	IP65 / IP67	YBB-14S4-0900-G012
	1,045	1,154	IR 950	27.6	8	129	-35 ... +60°C	IP65 / IP67	YBB-14S4-1000-G012
	1,174	1,283	IR 950	30.8	8	145	-35 ... +60°C	IP65 / IP67	YBB-14S4-1200-G012
	1,303	1,412	IR 950	34	8	161	-35 ... +60°C	IP65 / IP67	YBB-14S4-1300-G012
	1,432	1,541	IR 950	37.2	8	177	-35 ... +60°C	IP65 / IP67	YBB-14S4-1400-G012
	1,561	1,670	IR 950	40.4	8	193	-35 ... +60°C	IP65 / IP67	YBB-14S4-1600-G012
	1,690	1,799	IR 950	43.6	8	209	-35 ... +60°C	IP65 / IP67	YBB-14S4-1700-G012
	142	251	IR 950	5.2	8	17	-35 ... +60°C	IP65 / IP67	YBB-14R4-0150-G012
	271	380	IR 950	8.4	8	33	-35 ... +60°C	IP65 / IP67	YBB-14R4-0250-G012

# SAFETY LIGHT CURTAINS BASIC STANDARD

## COMMON FEATURES

<b>Safety Level</b>	Cat. 4, PL e, Type 4
<b>Supply Voltage</b>	24 VDC
<b>Polarity</b>	PNP
<b>Resolution</b>	14 mm (finger)

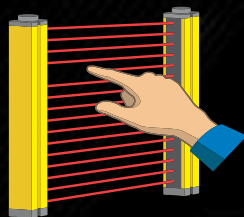

## FINGER PROTECTION TYPE 4

## OUTPUT

YBB-14[x]4-[xxxx]-[xxxx]











**Protective height rounded (mm)**

**Module**  
[K] Kit (sender + receiver)  
[R] Receiver  
[S] Sender

**Connection type**  
[G012] M12 connector, 5 pins

Reference key on page 258

## ACCESSORIES

-  **Relay**  
See page 256
-  **Top/bottom mounting bracket**  
For YBB & YCA  
See page 256
-  **Sliding T-nuts for side mounting**  
See page 256
-  **Mounting bracket No. 5**  
For YBBS & YBES  
See page 256
-  **Mounting bracket No. 6**  
For YBBS & YBES  
See page 256
-  **Mounting bracket No. 7**  
For YBBS & YBES  
See page 256
-  **Safety filter**  
See page 257
-  **Laser alignment tool**  
See page 257
-  **Device columns**  
See page 254
-  **Mirror columns**  
See page 254

Go to page 298 for details

FAMILY	OPERATING RANGE (mm)	HOUSING SIZE (mm)
FINGER PROTECTION – TYPE 4	0.25 ... 3.5 m	42 × 48 (standard)
	0.25 ... 3.5 m	42 × 48 (standard)
	0.25 ... 3.5 m	42 × 48 (standard)
	0.25 ... 3.5 m	42 × 48 (standard)
	0.25 ... 3.5 m	42 × 48 (standard)
	0.25 ... 3.5 m	42 × 48 (standard)
	0.25 ... 3.5 m	42 × 48 (standard)
	0.25 ... 3.5 m	42 × 48 (standard)
	0.25 ... 3.5 m	42 × 48 (standard)
	0.25 ... 3.5 m	42 × 48 (standard)



**KEY ADVANTAGES**

- ✓ Resolution: 14 mm
- ✓ Operating range: 0.25 ... 3.5 m
- ✓ Protective height: 142 ... 1,690 mm
- ✓ Category 4, PL e according to EN/ISO 13849-1
- ✓ Type 4 according to IEC 61496-1 and -2
- ✓ Certified TÜV, CE and UL
- ✓ IP65, IP67 with operating temperatures as low as -35°C (-31°F)
- ✓ Housing profile 42 × 48 mm
- ✓ 2-channel selection
- ✓ Optical synchronization
- ✓ Permanent autocontrol



PROTECTIVE HEIGHT (mm)	TOTAL HEIGHT (mm)	SENDER WAVELENGTH (nm)	RESPONSE TIME (ms)	BEAM GAP (mm)	NUMBER OF BEAMS	AMBIENT TEMPERATURE	DEGREE OF PROTECTION	PART REFERENCE
400	509	IR 950	11.6	8	49	-35 ... +60°C	IP65 / IP67	<b>YBB-14R4-0400-G012</b>
529	638	IR 950	14.8	8	65	-35 ... +60°C	IP65 / IP67	<b>YBB-14R4-0500-G012</b>
658	737	IR 950	18	8	81	-35 ... +60°C	IP65 / IP67	<b>YBB-14R4-0700-G012</b>
787	896	IR 950	21.2	8	97	-35 ... +60°C	IP65 / IP67	<b>YBB-14R4-0800-G012</b>
916	1,025	IR 950	24.4	8	113	-35 ... +60°C	IP65 / IP67	<b>YBB-14R4-0900-G012</b>
1,045	1,154	IR 950	27.6	8	129	-35 ... +60°C	IP65 / IP67	<b>YBB-14R4-1000-G012</b>
1,174	1,283	IR 950	30.8	8	145	-35 ... +60°C	IP65 / IP67	<b>YBB-14R4-1200-G012</b>
1,303	1,412	IR 950	34	8	161	-35 ... +60°C	IP65 / IP67	<b>YBB-14R4-1300-G012</b>
1,432	1,541	IR 950	37.2	8	177	-35 ... +60°C	IP65 / IP67	<b>YBB-14R4-1400-G012</b>
1,561	1,670	IR 950	40.4	8	193	-35 ... +60°C	IP65 / IP67	<b>YBB-14R4-1600-G012</b>
1,690	1,799	IR 950	43.6	8	209	-35 ... +60°C	IP65 / IP67	<b>YBB-14R4-1700-G012</b>

# SAFETY LIGHT CURTAINS BASIC STANDARD

## COMMON FEATURES





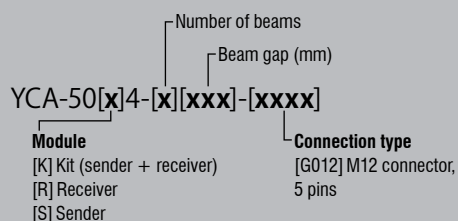





<b>Safety Level</b>	Cat. 4, PL e, Type 4
<b>Supply Voltage</b>	24 VDC
<b>Polarity</b>	PNP

## OUTPUT



Reference key on page 258

## ACCESSORIES

-  **Relay**  
See page 256
-  **Top/bottom mounting bracket**  
For YBB & YCA  
See page 256
-  **Sliding T-nuts for side mounting**  
See page 256
-  **Mounting bracket No. 5**  
For YBBS & YBES  
See page 256
-  **Mounting bracket No. 6**  
For YBBS & YBES  
See page 256
-  **Mounting bracket No. 7**  
For YBBS & YBES  
See page 256
-  **Safety filter**  
See page 257
-  **Laser alignment tool**  
See page 257
-  **Device columns**  
See page 254
-  **Mirror columns**  
See page 254

Go to page 298 for details



FAMILY	OPERATING RANGE (mm)	HOUSING SIZE (mm)
ACCESS CONTROL – TYPE 4	1 ... 15 m / 10 ... 50 m	42 × 48 (standard)
	1 ... 15 m / 10 ... 50 m	42 × 48 (standard)
	1 ... 15 m / 10 ... 50 m	42 × 48 (standard)
	1 ... 15 m / 10 ... 50 m	42 × 48 (standard)
	1 ... 15 m / 10 ... 50 m	42 × 48 (standard)
	1 ... 15 m / 10 ... 50 m	42 × 48 (standard)
	1 ... 15 m / 10 ... 50 m	42 × 48 (standard)
	1 ... 15 m / 10 ... 50 m	42 × 48 (standard)
	1 ... 15 m / 10 ... 50 m	42 × 48 (standard)
	1 ... 15 m / 10 ... 50 m	42 × 48 (standard)
	1 ... 15 m / 10 ... 50 m	42 × 48 (standard)
	1 ... 15 m / 10 ... 50 m	42 × 48 (standard)
	1 ... 15 m / 10 ... 50 m	42 × 48 (standard)
	1 ... 15 m / 10 ... 50 m	42 × 48 (standard)
1 ... 15 m / 10 ... 50 m	42 × 48 (standard)	



**KEY ADVANTAGES**

- ✓ Beam gap: 300, 400 or 500 mm (3 to 6 beams)
- ✓ Operating range: 1 ... 15 m or 10 ... 50 m (can be configured)
- ✓ Protective height: 832 ... 1,532 mm
- ✓ Category 4, PL e according to EN/ISO 13849-1
- ✓ Type 4 according to IEC 61496-1 and -2
- ✓ Certified TÜV, CE and UL
- ✓ IP65, IP67 with operating temperatures as low as  $-35^{\circ}\text{C}$  ( $-31^{\circ}\text{F}$ )
- ✓ Housing profile  $42 \times 48$  mm
- ✓ 2-channel selection
- ✓ Optical synchronization
- ✓ Permanent autocontrol



PROTECTIVE HEIGHT (mm)	TOTAL HEIGHT (mm)	SENDER WAVELENGTH (nm)	RESPONSE TIME (ms)	BEAM GAP (mm)	NUMBER OF BEAMS	AMBIENT TEMPERATURE	DEGREE OF PROTECTION	PART REFERENCE
832	1,025	IR 880	4.2	400	3	$-35 \dots +60^{\circ}\text{C}$	IP65 / IP67	<b>YCA-50K4-3400-G012</b>
1,032	1,154	IR 880	4.2	500	3	$-35 \dots +60^{\circ}\text{C}$	IP65 / IP67	<b>YCA-50K4-3500-G012</b>
832	1,025	IR 880	4.2	400	3	$-35 \dots +60^{\circ}\text{C}$	IP65 / IP67	<b>YCA-50S4-3400-G012</b>
1,032	1,154	IR 880	4.2	500	3	$-35 \dots +60^{\circ}\text{C}$	IP65 / IP67	<b>YCA-50S4-3500-G012</b>
832	1,025	IR 880	4.2	400	3	$-35 \dots +60^{\circ}\text{C}$	IP65 / IP67	<b>YCA-50R4-3400-G012</b>
1,032	1,154	IR 880	4.2	500	3	$-35 \dots +60^{\circ}\text{C}$	IP65 / IP67	<b>YCA-50R4-3500-G012</b>
932	1,154	IR 880	5.0	300	4	$-35 \dots +60^{\circ}\text{C}$	IP65 / IP67	<b>YCA-50K4-4300-G012</b>
1,232	1,412	IR 880	5.0	400	4	$-35 \dots +60^{\circ}\text{C}$	IP65 / IP67	<b>YCA-50K4-4400-G012</b>
932	1,154	IR 880	5.0	300	4	$-35 \dots +60^{\circ}\text{C}$	IP65 / IP67	<b>YCA-50S4-4300-G012</b>
1,232	1,412	IR 880	5.0	400	4	$-35 \dots +60^{\circ}\text{C}$	IP65 / IP67	<b>YCA-50S4-4400-G012</b>
932	1,154	IR 880	5.0	300	4	$-35 \dots +60^{\circ}\text{C}$	IP65 / IP67	<b>YCA-50R4-4300-G012</b>
1,232	1,412	IR 880	5.0	400	4	$-35 \dots +60^{\circ}\text{C}$	IP65 / IP67	<b>YCA-50R4-4400-G012</b>
1,232	1,412	IR 880	5.9	300	5	$-35 \dots +60^{\circ}\text{C}$	IP65 / IP67	<b>YCA-50K4-5300-G012</b>
1,232	1,412	IR 880	5.9	300	5	$-35 \dots +60^{\circ}\text{C}$	IP65 / IP67	<b>YCA-50S4-5300-G012</b>
1,232	1,412	IR 880	5.9	300	5	$-35 \dots +60^{\circ}\text{C}$	IP65 / IP67	<b>YCA-50R4-5300-G012</b>
1,532	1,670	IR 880	6.7	300	6	$-35 \dots +60^{\circ}\text{C}$	IP65 / IP67	<b>YCA-50K4-6300-G012</b>
1,532	1,670	IR 880	6.7	300	6	$-35 \dots +60^{\circ}\text{C}$	IP65 / IP67	<b>YCA-50S4-6300-G012</b>
1,532	1,670	IR 880	6.7	300	6	$-35 \dots +60^{\circ}\text{C}$	IP65 / IP67	<b>YCA-50R4-6300-G012</b>

# SAFETY LIGHT CURTAINS BASIC SLIM

## COMMON FEATURES

<b>Safety Level</b>	Cat. 2, PL c, Type 2
<b>Supply Voltage</b>	24 VDC
<b>Polarity</b>	PNP
<b>Resolution</b>	30 mm (hand)

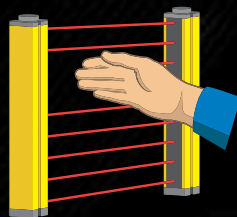

# HAND PROTECTION TYPE 2

## OUTPUT

Protective height rounded (mm)











YBBS-30[x]2-[xxxx]-[xxxx]

Module  
[K] Kit (sender + receiver)  
[R] Receiver  
[S] Sender

Connection type  
[P012] M12 pigtail,  
0.3 m, 5 pins

Reference key on page 258

## ACCESSORIES

-  **Relay**  
See page 256
-  **Top/bottom mounting bracket**  
For YBB & YCA  
See page 256
-  **Sliding T-nuts for side mounting**  
See page 256
-  **Mounting bracket No. 5**  
For YBBS & YBES  
See page 256
-  **Mounting bracket No. 6**  
For YBBS & YBES  
See page 256
-  **Mounting bracket No. 7**  
For YBBS & YBES  
See page 256
-  **Safety filter**  
See page 257
-  **Laser alignment tool**  
See page 257
-  **Device columns**  
See page 254
-  **Mirror columns**  
See page 254

Go to page 298 for details

FAMILY	OPERATING RANGE (mm)	HOUSING SIZE (mm)
HAND PROTECTION – TYPE 2	0.25 ... 8 m	26 × 26 (slim)
	0.25 ... 8 m	26 × 26 (slim)
	0.25 ... 8 m	26 × 26 (slim)
	0.25 ... 8 m	26 × 26 (slim)
	0.25 ... 8 m	26 × 26 (slim)
	0.25 ... 8 m	26 × 26 (slim)
	0.25 ... 8 m	26 × 26 (slim)
	0.25 ... 8 m	26 × 26 (slim)
	0.25 ... 8 m	26 × 26 (slim)
	0.25 ... 8 m	26 × 26 (slim)
	0.25 ... 8 m	26 × 26 (slim)
	0.25 ... 8 m	26 × 26 (slim)
	0.25 ... 8 m	26 × 26 (slim)
	0.25 ... 8 m	26 × 26 (slim)
	0.25 ... 8 m	26 × 26 (slim)
	0.25 ... 8 m	26 × 26 (slim)
	0.25 ... 8 m	26 × 26 (slim)
	0.25 ... 8 m	26 × 26 (slim)
	0.25 ... 8 m	26 × 26 (slim)
	0.25 ... 8 m	26 × 26 (slim)



**KEY ADVANTAGES**

- ✓ Resolution: 30 mm
- ✓ Operating range: 0.25 ... 8 m
- ✓ Protective height: 170 ... 1,610 mm
- ✓ No blind zone
- ✓ Category 2, PL c according to EN/ISO 13849-1
- ✓ Type 2 according to IEC 61496-1 and -2
- ✓ Certified TÜV, CE
- ✓ Enclosure rating IP65
- ✓ Housing profile 26 × 26 mm
- ✓ Optical synchronization
- ✓ Permanent autocontrol

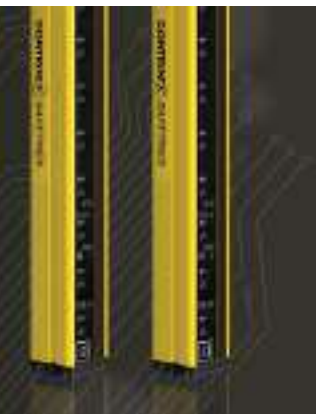

PROTECTIVE HEIGHT (mm)	TOTAL HEIGHT (mm)	SENDER WAVELENGTH (nm)	RESPONSE TIME (ms)	BEAM GAP (mm)	NUMBER OF BEAMS	AMBIENT TEMPERATURE	DEGREE OF PROTECTION	PART REFERENCE
170	170	IR 850	6	20	8	0 ... +55°C	IP65	YBBS-30K2-0170-P012
330	330	IR 850	9	20	16	0 ... +55°C	IP65	YBBS-30K2-0330-P012
490	490	IR 850	11	20	24	0 ... +55°C	IP65	YBBS-30K2-0490-P012
650	650	IR 850	14	20	32	0 ... +55°C	IP65	YBBS-30K2-0650-P012
810	810	IR 850	16	20	40	0 ... +55°C	IP65	YBBS-30K2-0810-P012
970	970	IR 850	19	20	48	0 ... +55°C	IP65	YBBS-30K2-0970-P012
1,130	1,130	IR 850	21	20	56	0 ... +55°C	IP65	YBBS-30K2-1130-P012
1,290	1,290	IR 850	24	20	64	0 ... +55°C	IP65	YBBS-30K2-1290-P012
1,450	1,450	IR 850	26	20	72	0 ... +55°C	IP65	YBBS-30K2-1450-P012
1,610	1,610	IR 850	29	20	80	0 ... +55°C	IP65	YBBS-30K2-1610-P012
170	170	IR 850	6	20	8	0 ... +55°C	IP65	YBBS-30S2-0170-P012
330	330	IR 850	9	20	16	0 ... +55°C	IP65	YBBS-30S2-0330-P012
490	490	IR 850	11	20	24	0 ... +55°C	IP65	YBBS-30S2-0490-P012
650	650	IR 850	14	20	32	0 ... +55°C	IP65	YBBS-30S2-0650-P012
810	810	IR 850	16	20	40	0 ... +55°C	IP65	YBBS-30S2-0810-P012
970	970	IR 850	19	20	48	0 ... +55°C	IP65	YBBS-30S2-0970-P012
1,130	1,130	IR 850	21	20	56	0 ... +55°C	IP65	YBBS-30S2-1130-P012
1,290	1,290	IR 850	24	20	64	0 ... +55°C	IP65	YBBS-30S2-1290-P012
1,450	1,450	IR 850	26	20	72	0 ... +55°C	IP65	YBBS-30S2-1450-P012
1,610	1,610	IR 850	29	20	80	0 ... +55°C	IP65	YBBS-30S2-1610-P012
170	170	IR 850	6	20	8	0 ... +55°C	IP65	YBBS-30R2-0170-P012
330	330	IR 850	9	20	16	0 ... +55°C	IP65	YBBS-30R2-0330-P012
490	490	IR 850	11	20	24	0 ... +55°C	IP65	YBBS-30R2-0490-P012
650	650	IR 850	14	20	32	0 ... +55°C	IP65	YBBS-30R2-0650-P012
810	810	IR 850	16	20	40	0 ... +55°C	IP65	YBBS-30R2-0810-P012
970	970	IR 850	19	20	48	0 ... +55°C	IP65	YBBS-30R2-0970-P012
1,130	1,130	IR 850	21	20	56	0 ... +55°C	IP65	YBBS-30R2-1130-P012
1,290	1,290	IR 850	24	20	64	0 ... +55°C	IP65	YBBS-30R2-1290-P012

# SAFETY LIGHT CURTAINS BASIC SLIM

## COMMON FEATURES

<b>Safety Level</b>	Cat. 2, PL c, Type 2
<b>Supply Voltage</b>	24 VDC
<b>Polarity</b>	PNP
<b>Resolution</b>	30 mm (hand)

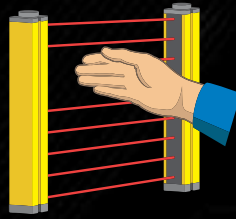

# HAND PROTECTION TYPE 2

## OUTPUT

YBBS-30[x]2-[xxxx]-[xxxx]











**Protective height rounded (mm)**

**Module**  
[K] Kit (sender + receiver)  
[R] Receiver  
[S] Sender

**Connection type**  
[P012] M12 pigtail, 0.3 m, 5 pins

Reference key on page 258

## ACCESSORIES

-  **Relay**  
See page 256
-  **Top/bottom mounting bracket**  
For YBB & YCA  
See page 256
-  **Sliding T-nuts for side mounting**  
See page 256
-  **Mounting bracket No. 5**  
For YBBS & YBES  
See page 256
-  **Mounting bracket No. 6**  
For YBBS & YBES  
See page 256
-  **Mounting bracket No. 7**  
For YBBS & YBES  
See page 256
-  **Safety filter**  
See page 257
-  **Laser alignment tool**  
See page 257
-  **Device columns**  
See page 254
-  **Mirror columns**  
See page 254

Go to page 298 for details

FAMILY	OPERATING RANGE (mm)	HOUSING SIZE (mm)
HAND PROTECTION – TYPE 2	0.25 ... 8 m	26 × 26 (slim)
	0.25 ... 8 m	26 × 26 (slim)



**KEY ADVANTAGES**

- ✓ Resolution: 30 mm
- ✓ Operating range: 0.25 ... 8 m
- ✓ Protective height: 170 ... 1,610 mm
- ✓ No blind zone
- ✓ Category 2, PL c according to EN/ISO 13849-1
- ✓ Type 2 according to IEC 61496-1 and -2
- ✓ Certified TÜV, CE
- ✓ Enclosure rating IP65
- ✓ Housing profile 26 × 26 mm
- ✓ Optical synchronization
- ✓ Permanent autocontrol



PROTECTIVE HEIGHT (mm)	TOTAL HEIGHT (mm)	SENDER WAVELENGTH (nm)	RESPONSE TIME (ms)	BEAM GAP (mm)	NUMBER OF BEAMS	AMBIENT TEMPERATURE	DEGREE OF PROTECTION	PART REFERENCE
1,450	1,450	IR 850	26	20	72	0 ... +55°C	IP65	YBBS-30R2-1450-P012
1,610	1,610	IR 850	29	20	80	0 ... +55°C	IP65	YBBS-30R2-1610-P012





## APPLICATION

### Wireless monitoring of hand protection system for automated solar cell assembly

Solar cell production uses potentially hazardous chemicals, and the solar cells themselves can be damaged by improper handling. In an automated assembly line, the hand-protection system must therefore ensure maximum protection of both the operator and the product, while minimizing disruption to operations. This is most efficiently achieved through a system of light curtains with wireless configuration, EDM and restart interlock. These light curtains do not require wired relays, a significant saving for scaled up operations.

## INDUSTRIES

Automotive production and supply, machine tool, packaging, logistics, materials handling, textile, assembly, automation, robotics



*Automotive industry*



*Logistics*



*Packaging systems*



*Robotics*

# EXTENDED SAFETY LIGHT CURTAINS

## WIRELESS CONFIGURATION VIA BLUETOOTH®

Type 4 light curtains from the **Extended Slim** range are TÜV, CE and UL certified according to IEC 61496-1/2, IEC 61508-1/2/3 and ISO 13849-1. Protective heights range from 170 to 1,610 mm with integrated EDM\*, restart interlock and beam coding. Since EDM includes a relay monitoring function, users can also avoid the cost of wired relays. The slim housing (26 × 26 mm) enables blind-zone free installation and connection is via an integral 5-pin or 8-pin M12 pigtail. This range of light curtains is configured and monitored wirelessly via a Bluetooth® signal and free smartphone app – a world first!

\*External Device Monitoring

### KEY ADVANTAGES

- ✓ Beam resolution 30 mm (hand) or 14 mm (finger)
- ✓ Highest protection category: Type 4
- ✓ Max operating range 5 m
- ✓ No blind zone
- ✓ Beam coding (3 channels), EDM, start and restart interlock configurable functions
- ✓ Wireless configuration via Bluetooth®
- ✓ Operating temperature 0... +55°C (+32... +131°F)
- ✓ Slim housing (26 × 26 mm), IP65



### PRODUCT OVERVIEW

	SERIES Type	FINGER 4	HAND 4
PROTECTIVE HEIGHT (mm)	Extended Slim	170 ... 1,290	170 ... 1,610

### ACCESSORIES

Go to pages 256 and 298 to see all the accessories



Relay



Mounting brackets

# SAFETY LIGHT CURTAINS EXTENDED SLIM

## COMMON FEATURES

<b>Safety Level</b>	Cat. 4, PL e, Type 4, SIL 3
<b>Supply Voltage</b>	24 VDC
<b>Polarity</b>	PNP
<b>Resolution</b>	30 mm (hand)

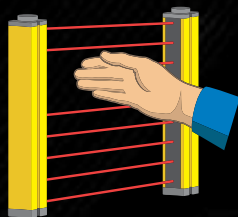

## HAND PROTECTION TYPE 4

## OUTPUT

Protective height rounded (mm)











YBES-30[x]4-[xxxx]-[xxxx]

Module  
[K] Kit (sender + receiver)  
[R] Receiver  
[S] Sender

Connection type  
[P012] M12 pigtail,  
0.3 m, 5 or 8 pins

Reference key on page 258

## ACCESSORIES

-  **Relay**  
See page 256
-  **Top/bottom mounting bracket**  
For YBB & YCA  
See page 256
-  **Sliding T-nuts for side mounting**  
See page 256
-  **Mounting bracket No. 5**  
For YBBS & YBES  
See page 256
-  **Mounting bracket No. 6**  
For YBBS & YBES  
See page 256
-  **Mounting bracket No. 7**  
For YBBS & YBES  
See page 256
-  **Safety filter**  
See page 257
-  **Laser alignment tool**  
See page 257
-  **Device columns**  
See page 254
-  **Mirror columns**  
See page 254

Go to page 298 for details

FAMILY	OPERATING RANGE (mm)	HOUSING SIZE (mm)
HAND PROTECTION – TYPE 4	0.25 ... 5 m	26 × 26 (slim)
	0.25 ... 5 m	26 × 26 (slim)
	0.25 ... 5 m	26 × 26 (slim)
	0.25 ... 5 m	26 × 26 (slim)
	0.25 ... 5 m	26 × 26 (slim)
	0.25 ... 5 m	26 × 26 (slim)
	0.25 ... 5 m	26 × 26 (slim)
	0.25 ... 5 m	26 × 26 (slim)
	0.25 ... 5 m	26 × 26 (slim)
	0.25 ... 5 m	26 × 26 (slim)
	0.25 ... 5 m	26 × 26 (slim)
	0.25 ... 5 m	26 × 26 (slim)
	0.25 ... 5 m	26 × 26 (slim)
	0.25 ... 5 m	26 × 26 (slim)
	0.25 ... 5 m	26 × 26 (slim)
	0.25 ... 5 m	26 × 26 (slim)
	0.25 ... 5 m	26 × 26 (slim)
	0.25 ... 5 m	26 × 26 (slim)
	0.25 ... 5 m	26 × 26 (slim)
	0.25 ... 5 m	26 × 26 (slim)



**KEY ADVANTAGES**

- ✓ Resolution: 30 mm
- ✓ Operating range: 0.25 ... 5 m
- ✓ Protective height: 170 ... 1,610 mm
- ✓ Wireless configuration through Bluetooth®
- ✓ No blind zone
- ✓ Category 4, PL e according to EN/ISO 13849-1
- ✓ Type 4 according to IEC 61496-1 and -2
- ✓ SIL 3 according to IEC 61508
- ✓ Certified TÜV, CE and UL
- ✓ Enclosure rating IP65
- ✓ Housing profile 26 × 26 mm
- ✓ Beam coding (3 channels), EDM, start and restart interlock configurable functions
- ✓ Optical synchronization
- ✓ Permanent autocontrol



PROTECTIVE HEIGHT (mm)	TOTAL HEIGHT (mm)	SENDER WAVELENGTH (nm)	RESPONSE TIME (ms)	BEAM GAP (mm)	NUMBER OF BEAMS	AMBIENT TEMPERATURE	DEGREE OF PROTECTION	PART REFERENCE
170	170	IR 850	7.8	20	8	0 ... +55°C	IP65	YBES-30K4-0170-P012
330	330	IR 850	9.6	20	16	0 ... +55°C	IP65	YBES-30K4-0330-P012
490	490	IR 850	11.4	20	24	0 ... +55°C	IP65	YBES-30K4-0490-P012
650	650	IR 850	13.2	20	32	0 ... +55°C	IP65	YBES-30K4-0650-P012
810	810	IR 850	15	20	40	0 ... +55°C	IP65	YBES-30K4-0810-P012
970	970	IR 850	16.8	20	48	0 ... +55°C	IP65	YBES-30K4-0970-P012
1,130	1,130	IR 850	18.6	20	56	0 ... +55°C	IP65	YBES-30K4-1130-P012
1,290	1,290	IR 850	20.4	20	64	0 ... +55°C	IP65	YBES-30K4-1290-P012
1,450	1,450	IR 850	22.2	20	72	0 ... +55°C	IP65	YBES-30K4-1450-P012
1,610	1,610	IR 850	24	20	80	0 ... +55°C	IP65	YBES-30K4-1610-P012
170	170	IR 850	7.8	20	8	0 ... +55°C	IP65	YBES-30S4-0170-P012
330	330	IR 850	9.6	20	16	0 ... +55°C	IP65	YBES-30S4-0330-P012
490	490	IR 850	11.4	20	24	0 ... +55°C	IP65	YBES-30S4-0490-P012
650	650	IR 850	13.2	20	32	0 ... +55°C	IP65	YBES-30S4-0650-P012
810	810	IR 850	15	20	40	0 ... +55°C	IP65	YBES-30S4-0810-P012
970	970	IR 850	16.8	20	48	0 ... +55°C	IP65	YBES-30S4-0970-P012
1,130	1,130	IR 850	18.6	20	56	0 ... +55°C	IP65	YBES-30S4-1130-P012
1,290	1,290	IR 850	20.4	20	64	0 ... +55°C	IP65	YBES-30S4-1290-P012
1,450	1,450	IR 850	22.2	20	72	0 ... +55°C	IP65	YBES-30S4-1450-P012
1,610	1,610	IR 850	24	20	80	0 ... +55°C	IP65	YBES-30S4-1610-P012
170	170	IR 850	7.8	20	8	0 ... +55°C	IP65	YBES-30R4-0170-P012
330	330	IR 850	9.6	20	16	0 ... +55°C	IP65	YBES-30R4-0330-P012
490	490	IR 850	11.4	20	24	0 ... +55°C	IP65	YBES-30R4-0490-P012
650	650	IR 850	13.2	20	32	0 ... +55°C	IP65	YBES-30R4-0650-P012
810	810	IR 850	15	20	40	0 ... +55°C	IP65	YBES-30R4-0810-P012
970	970	IR 850	16.8	20	48	0 ... +55°C	IP65	YBES-30R4-0970-P012
1,130	1,130	IR 850	18.6	20	56	0 ... +55°C	IP65	YBES-30R4-1130-P012
1,290	1,290	IR 850	20.4	20	64	0 ... +55°C	IP65	YBES-30R4-1290-P012

# SAFETY LIGHT CURTAINS EXTENDED SLIM

## COMMON FEATURES

<b>Safety Level</b>	Cat. 4, PL e, Type 4, SIL 3
<b>Supply Voltage</b>	24 VDC
<b>Polarity</b>	PNP
<b>Resolution</b>	30 mm (hand)

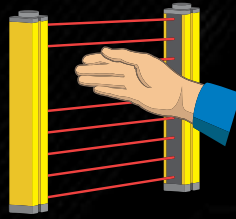

## HAND PROTECTION TYPE 4

## OUTPUT

YBES-30[x]4-[xxxx]-[xxxx]











**Protective height rounded (mm)**

**Module**  
[K] Kit (sender + receiver)  
[R] Receiver  
[S] Sender

**Connection type**  
[P012] M12 pigtail,  
0.3 m, 5 or 8 pins

Reference key on page 258

## ACCESSORIES

-  **Relay**  
See page 256
-  **Top/bottom mounting bracket**  
For YBB & YCA  
See page 256
-  **Sliding T-nuts for side mounting**  
See page 256
-  **Mounting bracket No. 5**  
For YBBS & YBES  
See page 256
-  **Mounting bracket No. 6**  
For YBBS & YBES  
See page 256
-  **Mounting bracket No. 7**  
For YBBS & YBES  
See page 256
-  **Safety filter**  
See page 257
-  **Laser alignment tool**  
See page 257
-  **Device columns**  
See page 254
-  **Mirror columns**  
See page 254

Go to page 298 for details

### FAMILY

### OPERATING RANGE (mm)

### HOUSING SIZE (mm)

0.25 ... 5 m

26 × 26 (slim)

0.25 ... 5 m

26 × 26 (slim)

HAND PROTECTION – TYPE 4



**KEY ADVANTAGES**

- ✓ Resolution: 30 mm
- ✓ Operating range: 0.25 ... 5 m
- ✓ Protective height: 170 ... 1,610 mm
- ✓ Wireless configuration through Bluetooth®
- ✓ No blind zone
- ✓ Category 4, PL e according to EN/ISO 13849-1
- ✓ Type 4 according to IEC 61496-1 and -2
- ✓ SIL 3 according to IEC 61508
- ✓ Certified TÜV, CE and UL
- ✓ Enclosure rating IP65
- ✓ Housing profile 26 × 26 mm
- ✓ Beam coding (3 channels), EDM, start and restart interlock configurable functions
- ✓ Optical synchronization
- ✓ Permanent autocontrol

PROTECTIVE HEIGHT (mm)	TOTAL HEIGHT (mm)	SENDER WAVELENGTH (nm)	RESPONSE TIME (ms)	BEAM GAP (mm)	NUMBER OF BEAMS	AMBIENT TEMPERATURE	DEGREE OF PROTECTION	PART REFERENCE
1,450	1,450	IR 850	22.2	20	72	0 ... +55°C	IP65	YBES-30R4-1450-P012
1,610	1,610	IR 850	24	20	80	0 ... +55°C	IP65	YBES-30R4-1610-P012



# SAFETY LIGHT CURTAINS EXTENDED SLIM

## COMMON FEATURES

<b>Safety Level</b>	Cat. 4, PL e, Type 4, SIL 3
<b>Supply Voltage</b>	24 VDC
<b>Polarity</b>	PNP
<b>Resolution</b>	14 mm (finger)

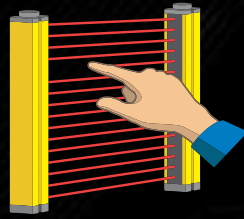

## FINGER PROTECTION TYPE 4

## OUTPUT

YBES-14[x]4-[xxxx]-[xxxx]











**Protective height rounded (mm)**

**Module**  
[K] Kit (sender + receiver)  
[R] Receiver  
[S] Sender

**Connection type**  
[P012] M12 pigtail,  
0.3 m, 5 or 8 pins

Reference key on page 258

## ACCESSORIES

-  **Relay**  
See page 256
-  **Top/bottom mounting bracket**  
For YBB & YCA  
See page 256
-  **Sliding T-nuts for side mounting**  
See page 256
-  **Mounting bracket No. 5**  
For YBBS & YBES  
See page 256
-  **Mounting bracket No. 6**  
For YBBS & YBES  
See page 256
-  **Mounting bracket No. 7**  
For YBBS & YBES  
See page 256
-  **Safety filter**  
See page 257
-  **Laser alignment tool**  
See page 257
-  **Device columns**  
See page 254
-  **Mirror columns**  
See page 254

Go to page 298 for details

FAMILY	OPERATING RANGE (mm)	HOUSING SIZE (mm)
FINGER PROTECTION – TYPE 4	0.4 ... 5 m	26 × 26 (slim)
	0.4 ... 5 m	26 × 26 (slim)
	0.4 ... 5 m	26 × 26 (slim)
	0.4 ... 5 m	26 × 26 (slim)
	0.4 ... 5 m	26 × 26 (slim)
	0.4 ... 5 m	26 × 26 (slim)
	0.4 ... 5 m	26 × 26 (slim)
	0.4 ... 5 m	26 × 26 (slim)
	0.4 ... 5 m	26 × 26 (slim)
	0.4 ... 5 m	26 × 26 (slim)
	0.4 ... 5 m	26 × 26 (slim)
	0.4 ... 5 m	26 × 26 (slim)
	0.4 ... 5 m	26 × 26 (slim)
	0.4 ... 5 m	26 × 26 (slim)
	0.4 ... 5 m	26 × 26 (slim)
	0.4 ... 5 m	26 × 26 (slim)
	0.4 ... 5 m	26 × 26 (slim)
	0.4 ... 5 m	26 × 26 (slim)
	0.4 ... 5 m	26 × 26 (slim)
	0.4 ... 5 m	26 × 26 (slim)



**KEY ADVANTAGES**

- ✓ Resolution: 14 mm
- ✓ Operating range: 0.4 ... 5 m
- ✓ Protective height: 170 ... 1,290 mm
- ✓ Wireless configuration through Bluetooth®
- ✓ No blind zone
- ✓ Category 4, PL e according to EN/ISO 13849-1
- ✓ Type 4 according to IEC 61496-1 and -2
- ✓ SIL 3 according to IEC 61508
- ✓ Certified TÜV, CE and UL
- ✓ Enclosure rating IP65
- ✓ Housing profile 26 × 26 mm
- ✓ Beam coding (3 channels), EDM, start and restart interlock configurable functions
- ✓ Optical synchronization
- ✓ Permanent autocontrol

PROTECTIVE HEIGHT (mm)	TOTAL HEIGHT (mm)	SENDER WAVELENGTH (nm)	RESPONSE TIME (ms)	BEAM GAP (mm)	NUMBER OF BEAMS	AMBIENT TEMPERATURE	DEGREE OF PROTECTION	PART REFERENCE
170	170	IR 850	9.6	10	16	0 ... +55°C	IP65	YBES-14K4-0170-P012
330	330	IR 850	13.2	10	32	0 ... +55°C	IP65	YBES-14K4-0330-P012
490	490	IR 850	16.8	10	48	0 ... +55°C	IP65	YBES-14K4-0490-P012
650	650	IR 850	20.4	10	64	0 ... +55°C	IP65	YBES-14K4-0650-P012
810	810	IR 850	24	10	80	0 ... +55°C	IP65	YBES-14K4-0810-P012
970	970	IR 850	27.6	10	96	0 ... +55°C	IP65	YBES-14K4-0970-P012
1,130	1,130	IR 850	31.2	10	112	0 ... +55°C	IP65	YBES-14K4-1130-P012
1,290	1,290	IR 850	34.8	10	128	0 ... +55°C	IP65	YBES-14K4-1290-P012
170	170	IR 850	9.6	10	16	0 ... +55°C	IP65	YBES-14S4-0170-P012
330	330	IR 850	13.2	10	32	0 ... +55°C	IP65	YBES-14S4-0330-P012
490	490	IR 850	16.8	10	48	0 ... +55°C	IP65	YBES-14S4-0490-P012
650	650	IR 850	20.4	10	64	0 ... +55°C	IP65	YBES-14S4-0650-P012
810	810	IR 850	24	10	80	0 ... +55°C	IP65	YBES-14S4-0810-P012
970	970	IR 850	27.6	10	96	0 ... +55°C	IP65	YBES-14S4-0970-P012
1,130	1,130	IR 850	31.2	10	112	0 ... +55°C	IP65	YBES-14S4-1130-P012
1,290	1,290	IR 850	34.8	10	128	0 ... +55°C	IP65	YBES-14S4-1290-P012
170	170	IR 850	9.6	10	16	0 ... +55°C	IP65	YBES-14R4-0170-P012
330	330	IR 850	13.2	10	32	0 ... +55°C	IP65	YBES-14R4-0330-P012
490	490	IR 850	16.8	10	48	0 ... +55°C	IP65	YBES-14R4-0490-P012
650	650	IR 850	20.4	10	64	0 ... +55°C	IP65	YBES-14R4-0650-P012
810	810	IR 850	24	10	80	0 ... +55°C	IP65	YBES-14R4-0810-P012
970	970	IR 850	27.6	10	96	0 ... +55°C	IP65	YBES-14R4-0970-P012
1,130	1,130	IR 850	31.2	10	112	0 ... +55°C	IP65	YBES-14R4-1130-P012
1,290	1,290	IR 850	34.8	10	128	0 ... +55°C	IP65	YBES-14R4-1290-P012



## APPLICATION

### Interlock system with RFID coding protects multiple access points on enclosed conveyor

Enclosed conveyors are an efficient way of preventing contamination in hygienic production systems. Doors onto the conveyor are provided wherever the operator needs access for set-up, maintenance or troubleshooting. To protect the operator and preserve process hygiene, RFID-coded safety sensors are fitted to each door. These cascadable devices with IP6K9K protection and Ecolab approval, are ideal for hygienic conveyor systems, where they reliably inhibit operation as soon as any door is opened.

## INDUSTRIES

Automotive production and supply, machine tool, packaging, logistics, materials handling, assembly, automation, robotics



*Robotics*



*Machine tools*



*Automotive industry*



*Logistics systems*

# SAFETY SENSORS

## MAGNETIC AND RFID

### NON-CONTACT MONITORING OF DOORS

**Magnetic** and **RFID** safety sensors are ideal for monitoring guard doors, hoods or covers. Their compact housings with standard fixing are particularly suitable for washdown applications in the food industry. RFID types are also ideal for multi-sensor applications, such as long assembly lines. Thanks to non-contact operation and coded communication, service life is very long.

#### KEY ADVANTAGES

- ✓ Up to category 4, PL e according to EN/ISO 13849-1
- ✓ Operating distance up to 18 mm
- ✓ PVC cable or M12 pigtail connection
- ✓ Certified TÜV, CE and UL
- ✓ IP6K9K, Ecolab

#### MAGNETIC

- ✓ Safety sensor with frontal or 90° actuation
- ✓ Magnetically coded, ISO 14119 type 4
- ✓ Detection through metal plate possible
- ✓ Sizes 36 × 26 × 13 mm and 88 × 25 × 13 mm

#### RFID

- ✓ Safety sensor with RFID coding (random or teachable) ISO 14119 type 4
- ✓ Compact size 36 × 26 × 13 mm
- ✓ Cascadable up to 30 units
- ✓ EDM and diagnostic function



#### PRODUCT OVERVIEW

	SERIES Housing size mm	CUBIC 36 × 26 × 13	RECTANGULAR 88 × 25 × 13
OPERATING RANGE (mm)	Magnetic	4... 18	8... 18
RFID		8... 18	–

#### ACCESSORIES

Go to pages 256 and 298 to see all the accessories

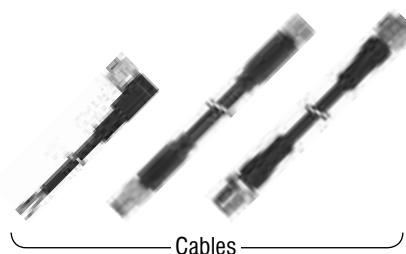

# SAFETY SENSORS MAGNETIC

## COMMON FEATURES

<b>Safety Level</b>	Cat. 4, PL e, SIL 3
<b>Supply Voltage</b>	24 VDC
<b>Temperature Range</b>	-25 ... +80°C
<b>Enclosure Rating</b>	IP6K9K

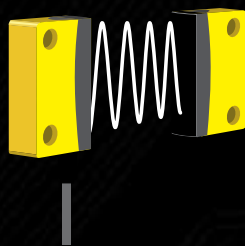

# SAFETY SENSORS MAGNETIC

## OUTPUT

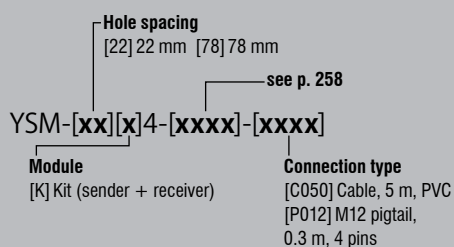

Reference key on page 258

## ACCESSORIES



**Relay**  
See page 256



**Top/bottom mounting bracket**  
For YBB & YCA  
See page 256



**Sliding T-nuts for side mounting**  
See page 256



**Mounting bracket No. 5**  
For YBBS & YBES  
See page 256



**Mounting bracket No. 6**  
For YBBS & YBES  
See page 256



**Mounting bracket No. 7**  
For YBBS & YBES  
See page 256



**Safety filter**  
See page 257



**Laser alignment tool**  
See page 257



**Device columns**  
See page 254



**Mirror columns**  
See page 254

Go to page 298 for details

FAMILY	SAFE SWITCH ON DISTANCE SAO (mm)	SAFE SWITCH OFF DISTANCE SAR (mm)	
CUBIC STANDARD	4	10	
	4	10	
	4	10	
	4	10	
CUBIC EXTENDED	8	17	
	8	17	
	8	17	
	8	17	
	8	17	
RECTANGULAR EXTENDED	8	18	
	8	18	
	8	18	
	8	18	
	8	18	



**KEY ADVANTAGES**

- ✓ Safety sensor with frontal or 90° actuation
- ✓ Magnetically coded, ISO 14119 type 4
- ✓ Up to category 4, PL e according to EN/ISO 13849-1
- ✓ Operating distance up to 18 mm
- ✓ PVC cable or M12 pigtail connection
- ✓ Sizes 36 × 26 × 13 mm and 88 × 25 × 13 mm
- ✓ Certified TÜV, CE and UL
- ✓ IP6K9K, Ecolab



	HOUSING SIZE (mm)	ACTUATION	NUMBER OF OUTPUTS	CABLE	CONNECTOR	PART REFERENCE
	36 × 26 × 13	Frontal	2 × NO	5 m PVC		YSM-22K4-MSFN-C050
	36 × 26 × 13	Frontal 90°	2 × NO	5 m PVC		YSM-22K4-MSAN-C050
	36 × 26 × 13	Frontal	2 × NO	0.15 m PVC	M12	YSM-22K4-MSFN-P012
	36 × 26 × 13	Frontal 90°	2 × NO	0.15 m PVC	M12	YSM-22K4-MSAN-P012
	36 × 26 × 13	Frontal	2 × NO	5 m PVC		YSM-22K4-MEFN-C050
	36 × 26 × 13	Frontal 90°	2 × NO	5 m PVC		YSM-22K4-MEAN-C050
	36 × 26 × 13	Frontal	2 × NO	0.15 m PVC	M12	YSM-22K4-MEFN-P012
	36 × 26 × 13	Frontal 90°	2 × NO	0.15 m PVC	M12	YSM-22K4-MEAN-P012
	36 × 26 × 13	Frontal	NO, NC	5 m PVC		YSM-22K4-MEFL-C050
	88 × 25 × 13	Frontal	2 × NO	5 m PVC		YSM-78K4-MEFN-C050
	88 × 25 × 13	Frontal 90°	2 × NO	5 m PVC		YSM-78K4-MEAN-C050
	88 × 25 × 13	Frontal	2 × NO	0.15 m PVC	M12	YSM-78K4-MEFN-P012
	88 × 25 × 13	Frontal 90°	2 × NO	0.15 m PVC	M12	YSM-78K4-MEAN-P012
	88 × 25 × 13	Frontal	NO, NC	5 m PVC		YSM-78K4-MEFL-C050

# SAFETY SENSORS RFID

## COMMON FEATURES

<b>Safety Level</b>	Cat. 4, PL e, SIL 3
<b>Supply Voltage</b>	24 VDC
<b>Temperature Range</b>	-25 ... +70°C
<b>Enclosure Rating</b>	IP6K9K

## OUTPUT

**Hole spacing**  
[22] 22 mm

**Module**  
[K] Kit (sender + receiver)

**Connection type**  
[C050] Cable, 5 m, PVC  
[P012] M12 pigtail, 0.3 m, 8 pins

see p. 258

YSR-[xx][x]4-[xxxx]-[xxxx]

Reference key on page 258

## ACCESSORIES

- Relay**  
See page 256
- Top/bottom mounting bracket**  
For YBB & YCA  
See page 256
- Sliding T-nuts for side mounting**  
See page 256
- Mounting bracket No. 5**  
For YBBS & YBES  
See page 256
- Mounting bracket No. 6**  
For YBBS & YBES  
See page 256
- Mounting bracket No. 7**  
For YBBS & YBES  
See page 256
- Safety filter**  
See page 257
- Laser alignment tool**  
See page 257
- Device columns**  
See page 254
- Mirror columns**  
See page 254

Go to page 298 for details

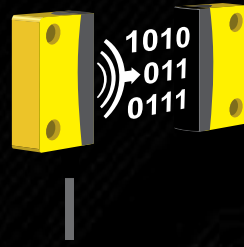

# SAFETY SENSORS RFID





FAMILY	SAFE SWITCH ON DISTANCE SAO (mm)	SAFE SWITCH OFF DISTANCE SAR (mm)	
CUBIC RANDOM	8	18	
	8	18	
CUBIC TEACH	8	18	
	8	18	

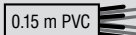

**KEY ADVANTAGES**

- ✓ Safety sensor with RFID coding (random or teachable) ISO 14119 type 4
- ✓ Category 4, PL e according to EN/ISO 13849-1
- ✓ Operating distance up to 18 mm
- ✓ PVC cable or M12 pigtail connection
- ✓ Compact size 36 × 26 × 13 mm
- ✓ Cascadable up to 30 units
- ✓ EDM and diagnostic function
- ✓ Certified TÜV, CE and UL
- ✓ IP6K9K, Ecolab

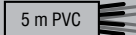
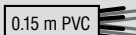

	HOUSING SIZE (mm)	ACTUATION	NUMBER OF OUTPUTS	CABLE	CONNECTOR	PART REFERENCE
	36 × 26 × 13	RFID random	2 × OSSD	5 m PVC 		YSR-22K4-RESE-C050
	36 × 26 × 13	RFID random	2 × OSSD	0.15 m PVC 	 M12	YSR-22K4-RESE-P012
	36 × 26 × 13	RFID teachable	2 × OSSD	5 m PVC 		YSR-22K4-TESE-C050
	36 × 26 × 13	RFID teachable	2 × OSSD	0.15 m PVC 	 M12	YSR-22K4-TESE-P012





Some light curtain applications require special accessories. For example, mirror columns can be used to deflect light beams for multi-sided protection. Also if the distance between the light-curtain sender and receiver is long, a laser tool simplifies alignment. Many other accessories are available in the Accessories section of this catalog (page 298).

# ACCESSORIES

## SAFETY

### MIRROR & DEVICE COLUMNS

### MISCELLANEOUS

#### KEY ADVANTAGES

##### MIRROR & DEVICE COLUMNS

- ✓ Multiple or single mirrors available
- ✓ Different heights available

##### MISCELLANEOUS

###### Relay

- ✓ Performance Level (PL) e and category 4 according to EN/ISO 13849-1
- ✓ Manual or automatic restart
- ✓ Short response time

###### Mounting Brackets

###### Top/bottom mounting brackets

- ✓ Synthetic mounting brackets
- ✓ Pair of brackets supplied with each bracket

###### Side/end mounting brackets

- ✓ Metal mounting brackets

###### Safety Filter

- ✓ Integrated RC filter for counter signal cut
- ✓ Possibility to connect sender and receiver unit on same connector

###### Laser alignment tool

- ✓ Easily clippable onto Safetinex YBB and YCA devices
- ✓ Range: up to 50 m



#### PRODUCT OVERVIEW

	Mirror and Device Columns	Relay	Mounting brackets	Safety filter	Laser alignment tool
Compatible with:					
	All light curtains	All light curtains and safety sensors	Extended Slim light curtains	All light curtains	All standard basic light curtains



# SAFETY ACCESSORIES DEVICE AND MIRROR COLUMNS

## OUTPUT

Column height  
in mm

YXC-[xxxx]-[xxx]

Column type  
[F00] Device (protection) column  
[M11] Single mirror column  
[M23] 3 mirror column  
[M24] 4 mirror column

Reference key on page 259

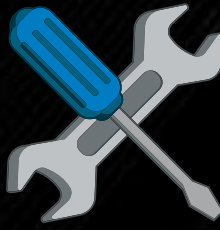

## SAFETY ACCESSORIES DEVICE AND MIRROR COLUMNS

## ACCESSORIES



**Relay**  
See page 256



**Top/bottom mounting bracket**  
For YBB & YCA  
See page 256



**Sliding T-nuts for side mounting**  
See page 256



**Mounting bracket No. 5**  
For YBBS & YBES  
See page 256



**Mounting bracket No. 6**  
For YBBS & YBES  
See page 256



**Mounting bracket No. 7**  
For YBBS & YBES  
See page 256



**Safety filter**  
See page 257



**Laser alignment tool**  
See page 257

Go to page 298 for details

FAMILY	COLUMN TYPE	PART REFERENCE
DEVICE AND MIRROR COLUMNS	Protective	YXC-0985-F00
	Protective	YXC-1285-F00
	Protective	YXC-1740-F00
	Protective	YXC-2040-F00
	Single mirror	YXC-1280-M11
	Single mirror	YXC-1715-M11
	Single mirror	YXC-2015-M11
	Single mirror	YXC-2215-M11
	Multiple mirror	YXC-1185-M23
	Multiple mirror	YXC-1285-M24

## PROTECTIVE COLUMN





**KEY ADVANTAGES**

- ✓ Robust protective profile, attractive design
- ✓ Special spring elements automatically reset position in case of mechanical impact
- ✓ Complete assembly kit for both device and floor mounting included
- ✓ Easy to mount: vertical and axial adjustments can be quickly completed in just a few steps
- ✓ Single mirror or exchangeable and separately adjustable individual mirrors in accordance with EN 999



	LENGTH L1 (mm)	LENGTH L2 (mm)	LENGTH L3 (mm)	LENGTH L4 (mm)	LENGTH L5 (mm)
	965	985	-	-	-
	1,265	1,285	-	-	-
	1,720	1,740	-	-	-
	2,020	2,040	-	-	-
	1,082	-	-	-	1,281
	1,532	-	-	-	1,716
	1,682	-	-	-	2,016
	1,832	-	-	-	2,216
	300	400	400	-	1,185
	300	300	300	300	1,285

**SINGLE MIRROR COLUMN**



**MULTIPLE MIRROR COLUMN**

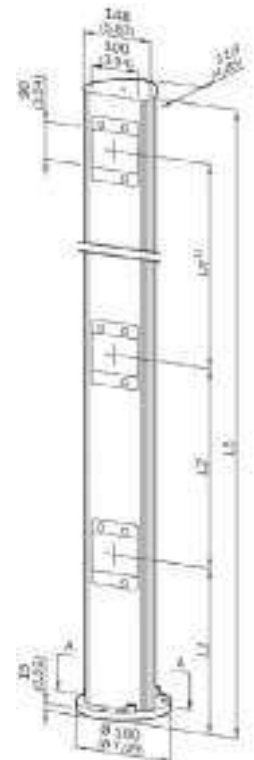

## RELAY



**YRB-4EML-31S**

TYPE	TYPICAL RESPONSE TIME	NUMBER OF CONTACTS	MAX. SWITCHING VOLTAGE	COMPATIBLE WITH	PART REFERENCE
SIL 3, PL e Cat 4	25 ms (manual start) / 100 ms (automatic start)	3 × NO / 1 × NC	250 V AC/DC	Light curtains and sensors	YRB-4EML-31S

## MOUNTING BRACKETS





DESCRIPTION	MATERIAL	COMPATIBLE WITH	PART REFERENCE
Top/bottom mounting bracket	Plastic	YBB and YCA series	YXW-0001-000
Sliding T-Nut for side mounting	Metal	YBB and YCA series	YXW-0003-000
Top/bottom mounting brackets	Plastic	YBES and YBBS series	YXW-0005-000
Side/end mounting brackets	Metal	YBES and YBBS series	YXW-0006-000
Side/end mounting brackets	Metal	YBES and YBBS series	YXW-0007-000

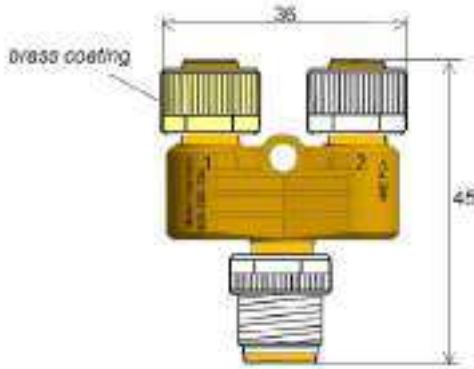

## T-CONNECTOR SAFETY FILTER



CONNECTOR A SIDE	PINS	RC FILTER	CONNECTION B SIDE	PART REFERENCE
 M12  M12	5 pins	✓	 M12	YXF-0002-000

## LASER ALIGNMENT TOOL



RANGE	LASER BEAM SPOT SIZE	LASER CLASS	POWER SUPPLY	COMPATIBLE WITH	PART REFERENCE
≤ 50 m	< 10 mm	1 mV (class 2)	AA batteries	YBB and YCA series	YXL-0001-000

# SAFETY REFERENCE KEY

## LIGHT CURTAINS AND SAFETY SENSORS

### YBB-30S4-0800-G012

**SAFETY PRODUCT** Y

#### PRODUCT TYPE

Basic standard barrier (light curtain)	<b>BB</b>
Access control barrier (light curtain)	<b>CA</b>
Basic slim barrier	<b>BBS</b>
Extended slim barrier	<b>BES</b>
Magnetic sensor	<b>SM</b>
RFID sensor	<b>SR</b>

#### ADDITIONAL INFORMATION

<b>Resolution (YBB)</b>	
14 mm (finger)	<b>14</b>
30 mm (hand)	<b>30</b>
<b>Operating distance (YCA)</b>	
50 m	<b>50</b>
<b>Hole spacing (YSM, YSR)</b>	
22 mm	<b>22</b>
78 mm	<b>78</b>

#### MODULE

Receiver	<b>R</b>
Sender	<b>S</b>
Kit (sender + receiver)	<b>K</b>
Reed sensor	<b>R</b>
Read/write RFID sensor	<b>L</b>
Actuator	<b>A</b>

#### CONNECTION TYPE

Cable, 5 m, PVC	<b>C050</b>
M12 connector, 5 pins	<b>G012</b>
M12 Pigtail, 0.3 m, 5 or 8 pins	<b>P012</b>

#### ADDITIONAL INFORMATION

<b>Light curtain</b>	
Protective height rounded in mm	<b>###</b>
<b>Coding (safety sensor)</b>	
Random RFID	<b>R###</b>
Teachable RFID	<b>T###</b>
Magnetic	<b>T###</b>
<b>Distance (safety sensor)</b>	
Standard	<b>#S##</b>
Extended	<b>#E##</b>
<b>Actuation (safety sensor)</b>	
Frontal	<b>##F#</b>
90°	<b>##A#</b>
All sides	<b>##S#</b>
<b>Options (safety sensor)</b>	
No option	<b>N</b>
Restart button	<b>R</b>
EDM	<b>E</b>
with LED	<b>L</b>

#### CATEGORY

Category 2	<b>2</b>
Category 4	<b>4</b>



SAFETY ACCESSORIES

# YRB-4EML-241

**SAFETY PRODUCT** Y

**PRODUCT TYPE**

Basic relay	<b>RB</b>
Light curtain column	<b>XC</b>
Laser alignment tool	<b>XL</b>
Mounting brackets	<b>XW</b>
Filter	<b>XF</b>
Spacer	<b>XS</b>

**ADDITIONAL INFORMATION**

<b>Relay (YRB)</b>	
Standard functions, 3 NO, 1 NC contacts	<b>4EML</b>
Muting functions, 3 NO contacts	<b>0330</b>
<b>Column (YXC)</b>	
Column height in mm (e.g. 1,060 mm)	<b>1060</b>
<b>Laser alignment tool (YXL)</b>	
Standard <1 mW (class 2)	<b>0001</b>
<b>Filter (YXF)</b>	
Standard filter	<b>0001</b>
<b>Spacer (YXS)</b>	
For YSM-22 series	<b>2200</b>
For YSM-78 series	<b>7800</b>
<b>Mounting brackets (YXW)</b>	
Top/bottom brackets (YBB/YCA)	<b>0001</b>
Sliding T-nuts (YBB/YCA)	<b>0003</b>
Top/bottom brackets (YBBS/YBES)	<b>0005</b>
Side brackets (YBBS/YBES)	<b>0006</b>
Side/end brackets (YBBS/YBES)	<b>0007</b>

**MIRROR / DEVICE COLUMN**

Device (protection) column	<b>F00</b>
Single mirror column	<b>M11</b>
3 mirror column	<b>M23</b>
4 mirror column	<b>M24</b>

**STANDARD ACCESSORIES** 000

**RELAY**

2 channels, type 4, width 22.5 mm	<b>31S</b>
2 channels, type 4, width 45 mm	<b>242</b>



# RADIO FREQUENCY IDENTIFICATION SYSTEMS (RFID)

## RFID

### LOW AND HIGH FREQUENCY

#### HIGHLIGHTS

- ✓ Low- and high-frequency (LF and HF) systems networkable on ContriNET or on conventional PC using USB connection
- ✓ Widest fieldbus coverage on market

#### LF SYSTEM

- ✓ All-metal housings, IP68 and IP69K
- ✓ Food safe and saltwater resistant (316L/V4A)
- ✓ All tags embeddable in metal

#### HF SYSTEM

- ✓ ISO/IEC 15693 compatible
- ✓ Fast data transfer time
- ✓ User-defined password protection features

#### NEW

- ✓ HF Read/Write Modules with  IO-Link
- ✓ HF tags for high temperatures
- ✓ LF and HF Read/Write Modules with USB connection

# INTRODUCTION

## RFID SYSTEMS

RFID (Radio Frequency IDentification) is used in numerous automation and logistics domains. It allows objects to be identified by means of electronic labels (transponders or tags).

Compared to classic systems, such as bar codes or laser marking, RFID technology offers important advantages. Transponder information can be read or written even when there is no direct line of sight between it and the Read/Write Module. In addition, information can be added, modified or replaced. It is a useful technology for automated production, reducing human error while increasing reliability, flexibility and traceability.

**ConIdent®** (also called ConID) is the general name of the Contrinex RFID system, including transponders, Read/Write Modules and interfaces in both low-frequency (LF) and high-frequency (HF) technology.

**ContriNET** is the product name of the Contrinex RFID network and protocol. The ContriNET protocol uses an RS-485 physical layer, which allows LF and/or HF Read/Write Modules to be daisy-chained, reducing the total number of interfaces.

- Up to 10 ContriNET RWMs with one USB interface
- Up to 31 ContriNET RWMs with one industrial bus interface
- Up to 254 ContriNET RWMs on a half-duplex RS-485 interface

While the usual interfaces allow connection of a limited number of Read/Write Modules (typically 4), ContriNET RWMs can be used to reduce the number of interfaces, which makes the cost of a ConID system more economic than competitive RFID products.

In principle, a ContriNET network can extend to a length of 200 m.

🔗 **IO-Link** is a point to point communication standard (ISO 61131-9), allowing the connection of a maximum of 8 RFID RWMs in parallel on a single IO-Link master, allowing a fast and easy machine setup and reducing programming cost.

RFID datas are exchanged over process data registers (input/output) at a constant cycle time (typically 10 ms) and Contrinex RWMs are compatible with any ISO 15693 transponder on the market. Maximum cable length between an IO-link device and a master is limited by the standard at 20 m.

Every RFID system can have one of the following three topologies:

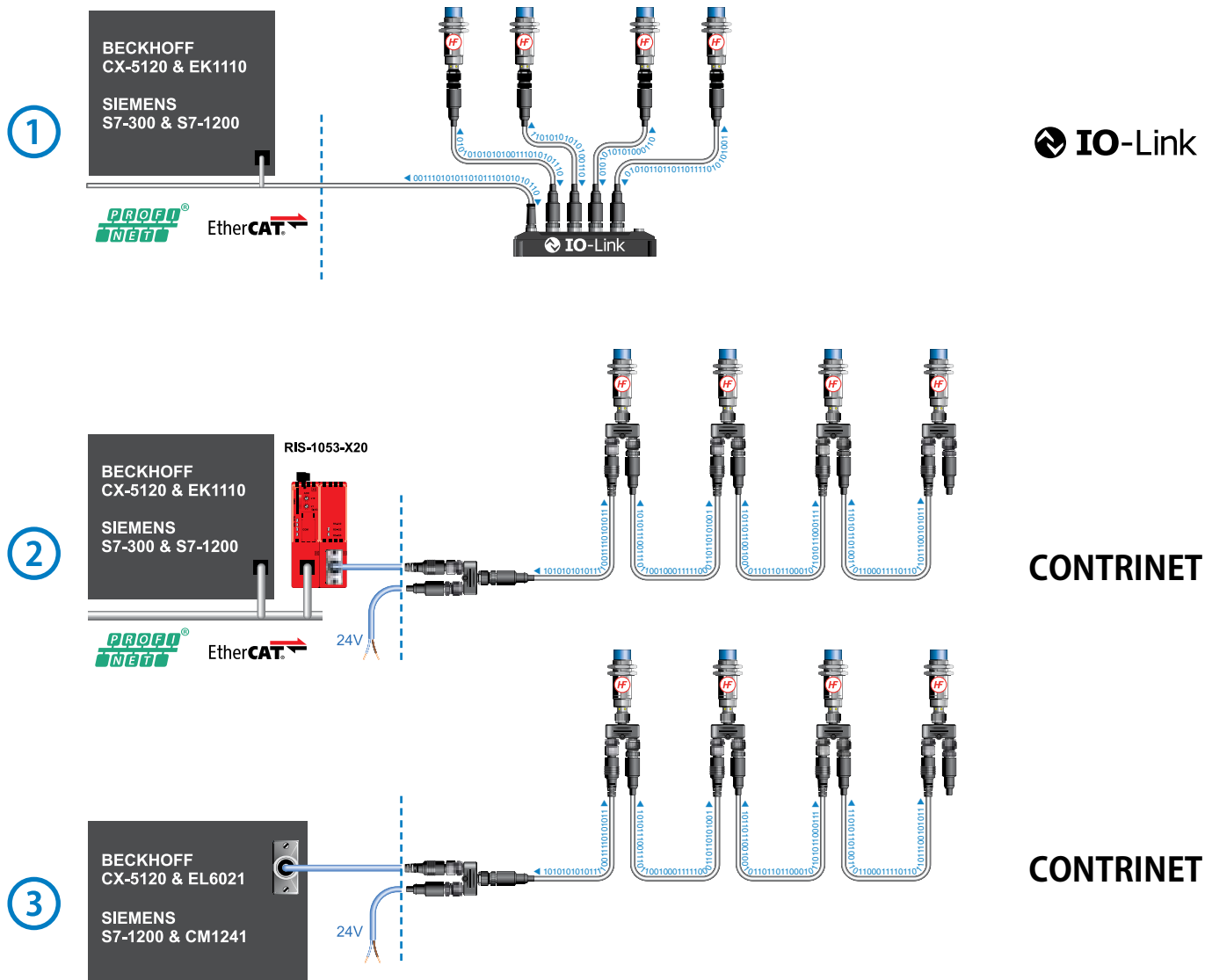

## TECHNOLOGY

### LOW-FREQUENCY (LF) RFID (31.25 kHz)



**Contrinex LF RFID technology** features not only conventional plastic components, but also a range of all-metal Read/Write Modules and transponders in stainless steel. These devices are particularly suitable for difficult operating environments where they will be exposed to cleaning, harsh chemicals, water and frost. They are also highly resistant to mechanical shocks.

- Non-standard technology (proprietary data communication)
- Reads and writes through metal
- Works in a metallic environment (fully embeddable)
- High resistance in harsh environments

### HIGH-FREQUENCY (HF) RFID (13.56 MHz)



**Contrinex HF RFID technology** complies with ISO/IEC 15693 and is therefore open to any components that meet this standard. HF systems allow fast communication between transponders and Read/Write Modules as well as extended functionality for tag data protection.

- ISO/IEC 15693
- Anti-collision, in case of multiple tag detection
- High-temperature tags embeddable in metal (180°C / 356°F)
- High-temperature tags for PWIS/LABS free applications (250°C / 428°F)

## RFID COMPONENTS

### TRANSPONDERS (TAGS)



A transponder is an electronic product that stores data. Transponder memory includes a unique pre-set number as an identifier and a memory area for writing user application data in relation to tagged product information. Writeable data may include, for example, the object's history or the parameters of operations to which it will be subjected.

### INTERFACES



An interface connects the Read/Write Modules to an industrial fieldbus. ConID interfaces are available for PROFIBUS, DeviceNet, EtherNet/IP, PROFINET, EtherCAT, POWERLINK, Ethernet TCP/IP and USB.

### READ/WRITE MODULES (RWMs)



A Read/Write Module is a device that allows data to be read from or written to a transponder.

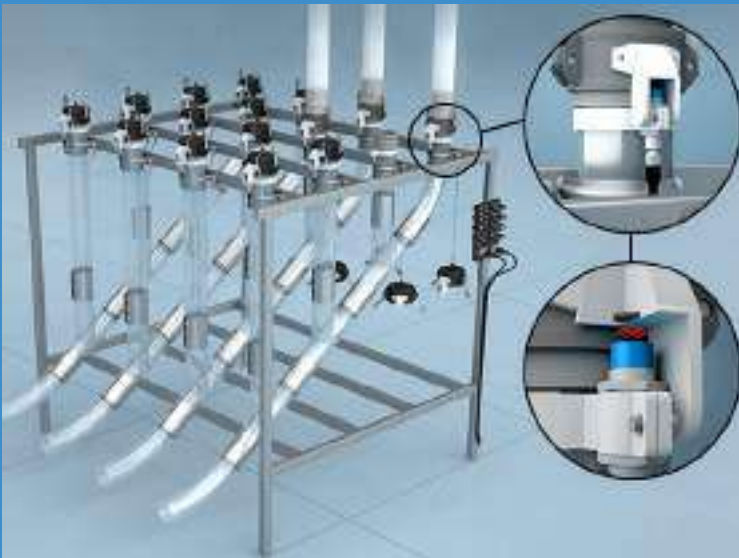

## APPLICATION

### RFID technology with IO-Link connectivity eliminates hose-coupling errors in fluidized pneumatic-transport systems

Bulk-handling- and pneumatic-transport-system designers use RFID technology to eliminate connection errors at manual hose-coupling stations for fluidizable materials. Coupling stations, with IO-Link-enabled RWMs mounted on each outlet pipe, use manual quick-release hoses to feed materials to multiple machines. RFID tags, mounted integrally within each hose coupling and blanking cap, identify the mating parts uniquely, allowing individual outlet/hose combinations to be verified at the time of connection.

## INDUSTRIES

Automotive production and supply, machine tool, packaging, logistics, materials handling, assembly, automation, robotics



*Machine tools*



*Packaging systems*



*Automotive industry*



*Robotics*

# IO-Link R/W MODULES

## RFID

**IO-Link – EASY TO GO!**

Ideal for Industry 4.0 solutions, IO-Link read/write modules (RWMs) combine two of the key communication standards in one device: ISO 15693 at the read-write head for communication with tags and ISO 61131-9 at the S12 connector for communication with the control system. Their simplified, plug-and-play installation ensures easy, cost-effective integration.

### KEY ADVANTAGES

- ✓ **IO-Link** protocol V1.1 with a single operating mode
- ✓ **IO-Link Device:**
  - ✓ Scan UID and Read/Write RFID data on transponder whether automatically or trigger based
  - ✓ Two alarms configurable to monitor transponder-in-range time or RSSI level
  - ✓ Get UID history list with time stamps
  - ✓ Secure mode to add security in the transponder memory access
  - ✓ Locate/FindMe function to quickly identify RWM mounted in a machine
  - ✓ New Diagnostic function such as individual system time, power-on cycle counter, RFID Error counter
- ✓ Stand-alone SIO: Switching on tag presence, data comparison and alarm conditions
- ✓ Temperature range  $-25^{\circ}\text{C} \dots +80^{\circ}\text{C}$  ( $-13 \dots 176^{\circ}\text{F}$ )
- ✓ Integral S12 connector with integrated bi-color LED
- ✓ IP67 (IP68 and IP69K for C44)



### PRODUCT OVERVIEW

IO-Link			
Housing size mm	M18	M30	C44
Read/write distance max (mm)	26/42	58/60	80

### ACCESSORIES

Go to page 290 to see all the accessories



**OUTPUT**

**Housing size**  
[M18] Cylindrical M18 [M30] Cylindrical M30  
[C44] Cubic C44

RLH-[xxx]PA-NIS

**Housing size**  
[18] M18 [30] M30

RLS-1[xx]1-320

Reference key on pages 294–297

**ACCESSORIES**

 **Starter kits**  
See page 292

 **Handheld devices**  
See page 292

 **RFID couplers**  
See page 293



 **Cables**  
See page 288

Go to page 298 for details



**RFID**  
 **IO-Link**

**READ/WRITE MODULES**

FAMILY	READ/WRITE DISTANCE MAX. (mm)	HOUSING SIZE (mm)	OPERATING FREQUENCY	STANDARD
	26	M18		ISO/IEC 15693
	42	M18		ISO/IEC 15693
	58	M30		ISO/IEC 15693
	60	M30		ISO/IEC 15693
	80	40 × 40 (C44)		ISO/IEC 15693



**KEY ADVANTAGES**

- ✓ **IO-Link** protocol V1.1 with a single operating mode
- ✓ **IO-Link Device:**
  - Scan UID and Read/Write RFID data on transponder whether automatically or trigger based
  - Two alarms configurable to monitor transponder in range time or RSSI level
  - Get UID history list with time stamps
  - Secure mode to add security in the transponder memory access
- Locate/FindMe function to quickly identify RWM mounted in a machine
- New Diagnostic function such as individual system time, power-on cycle counter, RFID Error counter
- ✓ Stand-alone SIO: Switching on tag presence, data comparison and alarm conditions
- ✓ Temperature range  $-25^{\circ}\text{C} \dots +80^{\circ}\text{C}$  ( $-13 \dots 176^{\circ}\text{F}$ )
- ✓ Integral S12 connector with integrated bi-color LED
- ✓ IP67 (IP68 and IP69K for C44)



	USER MEMORY SIZE (BYTE)	HOUSING MATERIAL	MOUNTING	INTERFACE	CONNECTION / CONNECTOR	AMBIENT TEMPERATURE	PART REFERENCE
	96	Chrome-plated brass	Non-embeddable	IO-Link × RFID	M12	$-25 \dots +80^{\circ}\text{C}$	<b>RLH-M18PA-NIS</b>
	16	Chrome-plated brass	Non-embeddable	IO-Link × RFID	M12	$-25 \dots +80^{\circ}\text{C}$	<b>RLS-1181-320</b>
	96	Chrome-plated brass	Non-embeddable	IO-Link × RFID	M12	$-25 \dots +80^{\circ}\text{C}$	<b>RLH-M30PA-NIS</b>
	16	Chrome-plated brass	Non-embeddable	IO-Link × RFID	M12	$-25 \dots +80^{\circ}\text{C}$	<b>RLS-1301-320</b>
	96	PBTP	Non-embeddable	IO-Link × RFID	M12	$-25 \dots +80^{\circ}\text{C}$	<b>RLH-C44PA-NIS</b>



## APPLICATION

### RFID technology for automated testing and tracking of individual motors

Product testing lines typically comprise several test stations, each performing a fixed sequence of tests. For efficient real-time monitoring, identification systems must integrate well into the overall control system.

In a typical RFID system, part carriers are equipped with tags and every test station has an RWM. To program the testing machine, the RWM reads from each tag the type of test required for an individual part. After each test, the RWM writes the results back into the appropriate tag memory address/location. Test reports are automatically forwarded to the controller for product acceptance or rejection and fault correction.

## INDUSTRIES

Automotive production and supply, machine tool, packaging, logistics, materials handling, assembly, automation, robotics



*Automotive industry*



*Packaging systems*



*Machine tools*



*Robotics*

# BASIC AND USB SYSTEM

## RFID

### FIRST CHOICE FOR HIGH AND LOW FREQUENCY

**Basic** transponders (tags) and read/write modules (RWMs) provide cost-effective solutions with ISO/IEC 15693-compatible HF transponders or proprietary LF transponders. Data protection is excellent, transfer time is fast and all components use the same ContriNET protocol with an RS-485 or USB physical layer. For hardware connection to a PC computer, USB RWMs are an ideal solution as they provide an USB output on their integral connector cable (2 m).

### KEY ADVANTAGES

#### Basic RWMs and tags

- ✓ ContriNET RS-485 protocol with outstanding fieldbus coverage
- ✓ LF and HF RWMs can be daisy-chained on same network
- ✓ HF and LF passive tags, no battery required
- ✓ LF tags embeddable in metal
- ✓ Insensitive to dirt
- ✓ Tag temperature range  $-40 \dots +125^{\circ}\text{C}$  ( $-40 \dots +257^{\circ}\text{F}$ ), IP67
- ✓ RWM temperature range  $-25 \dots +80^{\circ}\text{C}$  ( $-13 \dots +176^{\circ}\text{F}$ ), IP67, integral S12 connector

#### USB RWMs and interface

- ✓ ContriNET USB protocol for direct connection to PC (non-networkable)
- ✓ Compatible with ContriNET BASIC support tools and DEMO software
- ✓ DLL for easy development of custom solutions
- ✓ Temperature range  $-25 \dots +70^{\circ}\text{C}$  ( $-13 \dots +158^{\circ}\text{F}$ ), IP67, integral USB A male connector



### PRODUCT OVERVIEW

Housing size mm	M18	M30	C44
Read/write distance max (mm)	26/31/36	41/58/60	80

### ACCESSORIES

Go to page 290 to see all the accessories



# RFID BASIC AND USB SYSTEM

## OUTPUT

**Housing size**  
[M18] Cylindrical M18 [M30] Cylindrical M30  
[C44] Cubic C44

RLH-[xxx]PA-NSS

**Housing size**  
[18] M18 [30] M30  
**Technology**  
[2] ConIdent HF [3] ConIdent LF

RLS-1[xx][x]-0[x]0

**Material**  
[1] PBTP/Chrome-plated brass  
[3] PBTP/Stainless steel V2A

Reference key on pages 294–297

## ACCESSORIES

 **Starter kits**  
See page 292

 **Handheld devices**  
See page 292

 **RFID couplers**  
See page 293

 **Cables**  
See page 288

Go to page 298 for details



# RFID BASIC AND USB SYSTEM READ/WRITE MODULES







FAMILY	READ/WRITE DISTANCE MAX. (mm)	HOUSING SIZE (mm)	OPERATING FREQUENCY	STANDARD
BASIC	26	M18	HF	ISO/IEC 15693
	31	M18	HF	ISO/IEC 15693
	36	M18	LF	Proprietary
	41	M30	LF	Proprietary
	58	M30	HF	ISO/IEC 15693
	60	M30	HF	ISO/IEC 15693
	80	40 × 40 (C44)	HF	ISO/IEC 15693
USB	31	M18	HF	ISO/IEC 15693
	31	M18	HF	ISO/IEC 15693
	36	M18	LF	Proprietary
	41	M30	LF	Proprietary
	60	M30	HF	ISO/IEC 15693
	60	M30	HF	ISO/IEC 15693



**KEY ADVANTAGES**

- ✓ Powerful RS-485 network protocol for LF and HF systems
- ✓ Threaded Read/Write Modules (RWMs) with S12 connector and RS-485 output
- ✓ LF and HF RWMs can be mixed on the same network

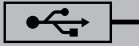
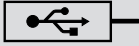
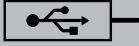
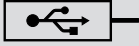
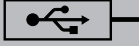
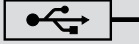

	USER MEMORY SIZE (BYTE)	HOUSING MATERIAL	MOUNTING	INTERFACE	CONNECTION / CONNECTOR	AMBIENT TEMPERATURE	PART REFERENCE
	400	Chrome-plated brass	Non-embeddable	ContriNET × RFID	 M12	−25 ... +80°C	<b>RLH-M18PA-NSS</b>
	400	Stainless steel V2A	Non-embeddable	ContriNET × RFID	 M12	−25 ... +80°C	<b>RLS-1183-020</b>
	400	Chrome-plated brass	Non-embeddable	ContriNET × RFID	 M12	−25 ... +80°C	<b>RLS-1181-030</b>
	400	Chrome-plated brass	Non-embeddable	ContriNET × RFID	 M12	−25 ... +80°C	<b>RLS-1301-030</b>
	400	Chrome-plated brass	Non-embeddable	ContriNET × RFID	 M12	−25 ... +80°C	<b>RLH-M30PA-NSS</b>
	400	Stainless steel V2A	Non-embeddable	ContriNET × RFID	 M12	−25 ... +80°C	<b>RLS-1303-020</b>
	400	PBTP	Non-embeddable	ContriNET × RFID	 M12	−25 ... +80°C	<b>RLH-C44PA-NSS</b>
	400	Chrome-plated brass	Non-embeddable	ContriNET USB × RFID	 —	−25 ... +70°C	<b>RLS-1181-220</b>
	400	Chrome-plated brass	Non-embeddable	ContriNET USB × RFID	 —	−25 ... +70°C	<b>RLS-1181-220-120</b>
	400	Chrome-plated brass	Non-embeddable	ContriNET USB × RFID	 —	−25 ... +70°C	<b>RLS-1181-230</b>
	400	Chrome-plated brass	Non-embeddable	ContriNET USB × RFID	 —	−25 ... +70°C	<b>RLS-1301-230</b>
	400	Chrome-plated brass	Non-embeddable	ContriNET USB × RFID	 —	−25 ... +70°C	<b>RLS-1301-220</b>
	400	Chrome-plated brass	Non-embeddable	ContriNET USB × RFID	 —	−25 ... +70°C	<b>RLS-1301-220-120</b>

# RFID BASIC AND USB SYSTEM

## OUTPUT

**Size**  
[D20] Ø20 mm [D30] Ø30 mm [D50] Ø50 mm

RTH-[xxx]QA-N[x]0

**Communication compatibility**  
[C] ICODE SLI-X  
[D] FRAM MBR89R118C

**Size**  
[# #] Diameter in mm

**Material**  
[0] Epoxy [1] PBTP

RLS-1[xx][x]-0[x]0

**Technology**  
[0] Low Frequency  
[2] High Frequency ICode SLI-S ISO 15693

Reference key on pages 294–297

## ACCESSORIES

 **Starter kits**  
See page 292

 **Handheld devices**  
See page 292

 **RFID couplers**  
See page 293

 **Cables**  
See page 288

Go to page 298 for details



# RFID BASIC AND USB SYSTEM TRANSPONDERS

FAMILY	HOUSING SIZE (mm)	USER MEMORY SIZE (BYTE)	READ/WRITE DISTANCE MAX. (mm)
BASIC AND USB	Ø 9	160	14
	Ø 16	160	30
	Ø 20	112	34
	Ø 20	160	25
	Ø 20	240	28
	Ø 20	2000	27
	Ø 30	112	44.5
	Ø 30	160	45
	Ø 30	240	29
	Ø 30	2000	45.5
	Ø 50	112	67
	Ø 50	160	60
	Ø 50	240	41
	Ø 50	2000	64.5



**KEY ADVANTAGES**

- ✓ ContriNET RS-485 protocol with outstanding fieldbus coverage
- ✓ HF and LF passive tags, no battery required
- ✓ LF tags embeddable in metal
- ✓ Insensitive to dirt
- ✓ Tag temperature range  $-40 \dots +125^{\circ}\text{C}$  ( $-40 \dots +257^{\circ}\text{F}$ ), IP67

	OPERATING FREQUENCY	STANDARD	HOUSING MATERIAL	MOUNTING	INTERFACE	STORAGE TEMPERATURE	AMBIENT TEMPERATURE	PART REFERENCE
		ISO/IEC 15693	PPS + epoxy	Non-embeddable	RFID	$-20 \dots +110^{\circ}\text{C}$	$-20 \dots +85^{\circ}\text{C}$	<b>RTP-0090-020</b>
		ISO/IEC 15693	PPS + epoxy	Non-embeddable	RFID	$-20 \dots +110^{\circ}\text{C}$	$-20 \dots +85^{\circ}\text{C}$	<b>RTP-0160-020</b>
		ISO/IEC 15693	PPA	Non-embeddable	RFID	$-40 \dots +90^{\circ}\text{C}$	$-25 \dots +80^{\circ}\text{C}$	<b>RTH-D20QA-NC0</b>
		ISO/IEC 15693	PBTP	Non-embeddable	RFID	$-40 \dots +125^{\circ}\text{C}$	$-25 \dots +85^{\circ}\text{C}$	<b>RTP-0201-020</b>
		Proprietary	PBTP	Embeddable	RFID	$-40 \dots +125^{\circ}\text{C}$	$-40 \dots +125^{\circ}\text{C}$	<b>RTP-0201-000</b>
		ISO/IEC 15693	PPA	Non-embeddable	RFID	$-40 \dots +90^{\circ}\text{C}$	$-25 \dots +80^{\circ}\text{C}$	<b>RTH-D20QA-ND0</b>
		ISO/IEC 15693	PPA	Non-embeddable	RFID	$-40 \dots +90^{\circ}\text{C}$	$-25 \dots +80^{\circ}\text{C}$	<b>RTH-D30QA-NC0</b>
		ISO/IEC 15693	PBTP	Non-embeddable	RFID	$-40 \dots +125^{\circ}\text{C}$	$-25 \dots +85^{\circ}\text{C}$	<b>RTP-0301-020</b>
		Proprietary	PBTP	Embeddable	RFID	$-40 \dots +125^{\circ}\text{C}$	$-40 \dots +125^{\circ}\text{C}$	<b>RTP-0301-000</b>
		ISO/IEC 15693	PPA	Non-embeddable	RFID	$-40 \dots +90^{\circ}\text{C}$	$-25 \dots +80^{\circ}\text{C}$	<b>RTH-D30QA-ND0</b>
		ISO/IEC 15693	PPA	Non-embeddable	RFID	$-40 \dots +90^{\circ}\text{C}$	$-25 \dots +80^{\circ}\text{C}$	<b>RTH-D50QA-NC0</b>
		ISO/IEC 15693	PBTP	Non-embeddable	RFID	$-40 \dots +125^{\circ}\text{C}$	$-25 \dots +85^{\circ}\text{C}$	<b>RTP-0501-020</b>
		Proprietary	PBTP	Embeddable	RFID	$-40 \dots +125^{\circ}\text{C}$	$-40 \dots +125^{\circ}\text{C}$	<b>RTP-0501-000</b>
		ISO/IEC 15693	PPA	Non-embeddable	RFID	$-40 \dots +90^{\circ}\text{C}$	$-25 \dots +80^{\circ}\text{C}$	<b>RTH-D50QA-ND0</b>



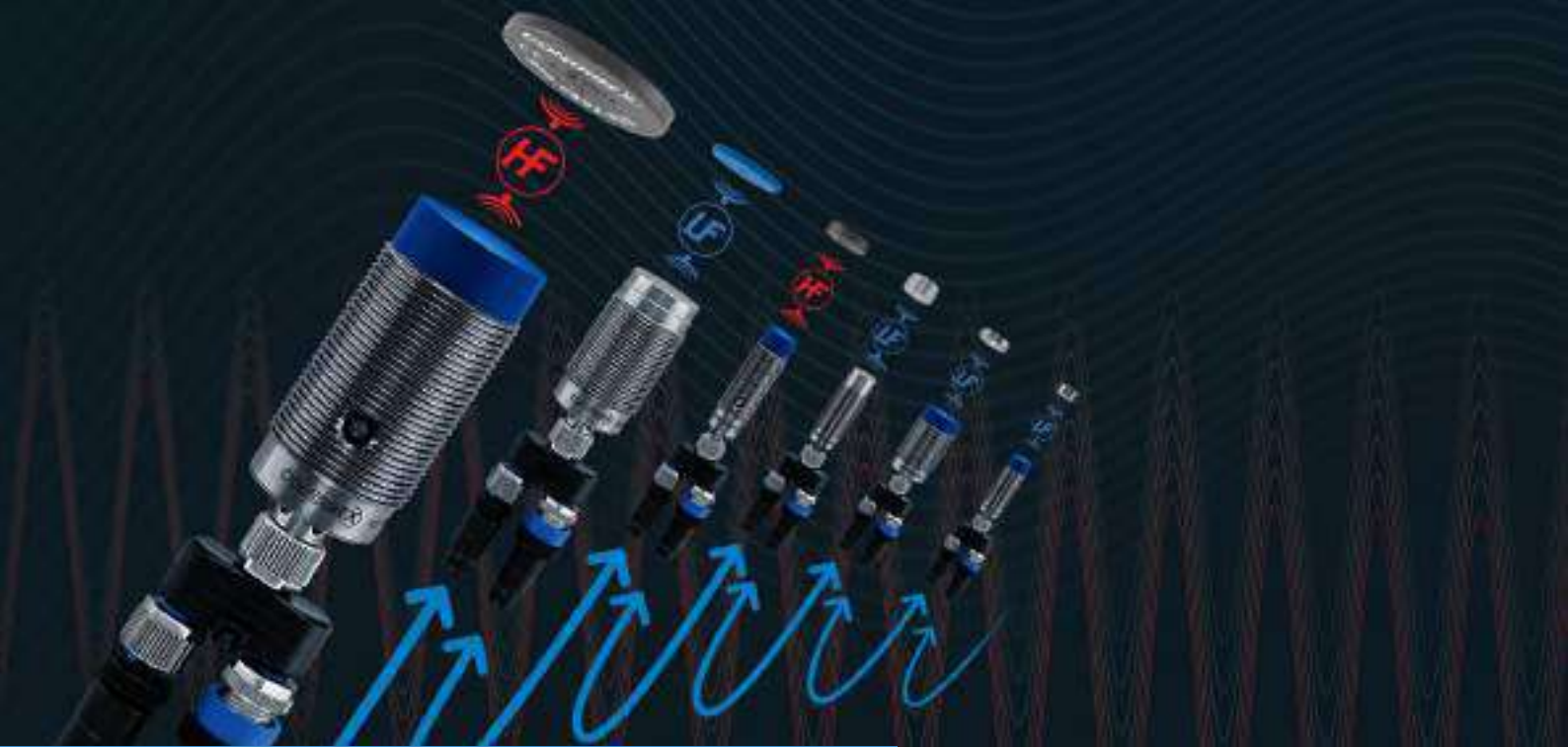

## APPLICATION

### RFID technology used to identify workpiece carriers and initiate automated washing

In the harsh environment of a washing station, RFID tags and RWMs are exposed to hot water, mechanical shocks, corrosive chemicals and high-pressure jetting. Despite these challenges, identification systems must operate continuously with high reliability. Typically, RFID tags are mounted on the part carriers. On arrival at the washing station, information from the tag is used to select the correct washing cycle for the part type and process.

## INDUSTRIES

Automotive production and supply, maritime, food and beverage



*Autoclave application*



*Automotive part sensing*



*Maritime industry*



*Brewery production equipment*

# EXTREME AND WASHDOWN RFID

## HIGHEST MECHANICAL AND CHEMICAL RESISTANCE

Read/write modules (RWMs) and embeddable tags from these two ranges feature robust, full-metal, stainless-steel construction. They offer outstanding performance in metallic environments and are insensitive to dirt and metal chips. For the highest mechanical and chemical resistance, **Washdown** components in food-grade stainless steel (V4A/AISI 316L) are fully sealed and laser welded. They function reliably when immersed in fluids such as water or oil.

### KEY ADVANTAGES

- ✓ LF passive tags, no battery required
- ✓ If the ContriNET protocol is used, LF components can share one network with HF types, including the full range of interfaces
- ✓ Insensitive to dirt
- ✓ Outstanding performance in metallic environments
- ✓ Tags readable/writable through metal
- ✓ Tags fully embeddable, including in metal
- ✓ Enclosure rating IP68 & IP69K

### Extreme RWMs and tags

- ✓ All-metal, stainless-steel housings (V2A/AISI 304) resist corrosion, impacts and abrasion
- ✓ Suitable for use in harsh environments, such as the steel industry, agriculture and other outdoor applications
- ✓ Temperature range: tags  $-40 \dots +95^{\circ}\text{C}$  ( $-40 \dots +203^{\circ}\text{F}$ ), RWMs  $-25 \dots +80^{\circ}\text{C}$  ( $-13 \dots +176^{\circ}\text{F}$ )

### Washdown RWMs and tags

- ✓ All-metal housings in food-grade stainless steel (V4A/AISI 316L) resist saltwater, solvents, corrosion, impacts and abrasion
- ✓ Designed for demanding clean-in-place (CIP) applications within the food, pharmaceutical and other industries
- ✓ Temperature range  $-40 \dots +125^{\circ}\text{C}$  ( $-40 \dots +257^{\circ}\text{F}$ )



## PRODUCT OVERVIEW

Housing size mm	M18	M30
Read/write distance max (mm)	12	12

## ACCESSORIES

Go to page 290 to see all the accessories



# RFID EXTREME AND WASHDOWN SYSTEM

## OUTPUT

**Housing size**  
 [18] M18 [30] M30  
**Temperature**  
 [0] Standard up to +80°C  
 [1] High up to +125°C  
**Material**  
 [0] Stainless steel V2A  
 [2] Stainless steel V4A

RLS-1[xx][x]-03[x]

Reference key on pages 294–297

## ACCESSORIES

 **Starter kits**  
See page 292

 **Handheld devices**  
See page 292





 **RFID couplers**  
See page 293

 **Cables**  
See page 288

Go to page 298 for details



# RFID EXTREME AND WASHDOWN SYSTEM READ/WRITE MODULES

FAMILY	READ/WRITE DISTANCE MAX. (mm)	HOUSING SIZE (mm)	OPERATING FREQUENCY	STANDARD
EXTREME	12	M18		Proprietary
	12	M30		Proprietary
WASH- DOWN	12	M18		Proprietary
	12	M30		Proprietary

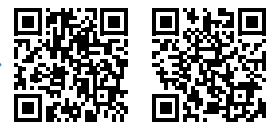

**KEY ADVANTAGES**

- ✓ If the ContriNET protocol is used, LF components can share one network with HF types, including the full range of interfaces
- ✓ Insensitive to dirt
- ✓ Outstanding performance in metallic environments
- ✓ Enclosure rating IP68 & IP69K
- ✓ Rugged all-metal LF RWMs with impervious sensing face





**Extreme**

- ✓ Temperature range  $-25 \dots +80^{\circ}\text{C}$   
( $-13 \dots +176^{\circ}\text{F}$ )

**Washdown**

- ✓ Temperature range  $-40 \dots +125^{\circ}\text{C}$   
( $-40 \dots +257^{\circ}\text{F}$ )



	USER MEMORY SIZE (BYTE)	HOUSING MATERIAL	MOUNTING	INTERFACE	CONNECTION / CONNECTOR	AMBIENT TEMPERATURE	PART REFERENCE
	400	Stainless steel V2A	Non-embeddable	ContriNET × RFID	 M12	$-25 \dots +80^{\circ}\text{C}$	<b>RLS-1180-030</b>
	400	Stainless steel V2A	Non-embeddable	ContriNET × RFID	 M12	$-25 \dots +80^{\circ}\text{C}$	<b>RLS-1300-030</b>
	400	Stainless steel V4A	Non-embeddable	ContriNET × RFID	 M12	$-40 \dots +125^{\circ}\text{C}$	<b>RLS-1182-031</b>
	400	Stainless steel V4A	Non-embeddable	ContriNET × RFID	 M12	$-40 \dots +125^{\circ}\text{C}$	<b>RLS-1302-031</b>



# RFID EXTREME AND WASHDOWN SYSTEM

## OUTPUT

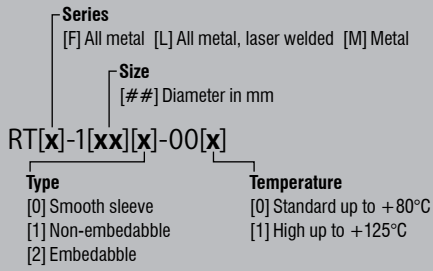

Reference key on pages 294–297

## ACCESSORIES

 **Starter kits**  
See page 292

 **Handheld devices**  
See page 292

 **RFID couplers**  
See page 293

 **Cables**  
See page 288

Go to page 298 for details



# RFID EXTREME AND WASHDOWN SYSTEM TRANSPONDERS

FAMILY	HOUSING SIZE (mm)	USER MEMORY SIZE (BYTE)	READ/WRITE DISTANCE MAX. (mm)
EXTREME	∅ 10	240	17
	∅ 16	240	19
	M16	240	13
	∅ 26	240	26
	M30	240	18
	M30	240	23
WASHDOWN	∅ 10	240	17
	∅ 16	240	13
	M16	240	13
	∅ 26	240	26
	M30	240	18
	M30	240	18



**KEY ADVANTAGES**

- ✓ LF passive tags, no battery required
- ✓ If the ContriNET protocol is used, LF components can share one network with HF types, including the full range of interfaces
- ✓ Insensitive to dirt
- ✓ Outstanding performance in metallic environments
- ✓ Tags readable/writable through metal
- ✓ Tags fully embeddable, including in metal
- ✓ Enclosure rating IP68 & IP69K

**Extreme**

- ✓ Temperature range -40 ... +95°C (-40 ... +203°F)

**Washdown**

- ✓ Temperature range -40 ... +125°C (-40 ... +257°F)

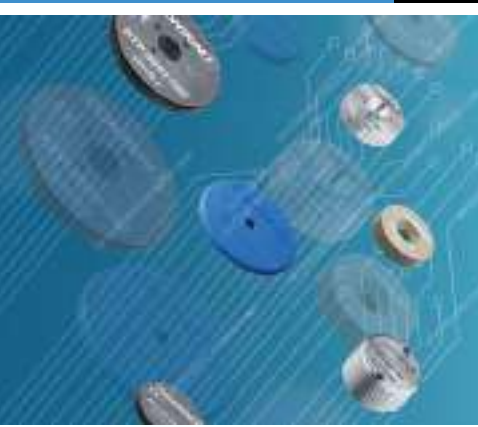

	OPERATING FREQUENCY	STANDARD	HOUSING MATERIAL	MOUNTING	INTERFACE	STORAGE TEMPERATURE	AMBIENT TEMPERATURE	PART REFERENCE
		Proprietary	Stainless steel V2A	Embeddable	RFID	-40 ... +95°C	-40 ... +80°C	<b>RTM-0100-000</b>
		Proprietary	Stainless steel V2A	Embeddable	RFID	-40 ... +95°C	-40 ... +80°C	<b>RTM-0160-000</b>
		Proprietary	Stainless steel V2A	Embeddable	RFID	-40 ... +95°C	-40 ... +80°C	<b>RTM-2160-000</b>
		Proprietary	Stainless steel V2A	Embeddable	RFID	-40 ... +95°C	-40 ... +80°C	<b>RTM-0260-000</b>
		Proprietary	Stainless steel V2A	Embeddable	RFID	-40 ... +95°C	-40 ... +80°C	<b>RTM-2300-000</b>
		Proprietary	Stainless steel V2A	Non-embeddable	RFID	-40 ... +95°C	-40 ... +80°C	<b>RTF-1300-000</b>
		Proprietary	Stainless steel V4A	Embeddable	RFID	-40 ... +125°C	-40 ... +125°C	<b>RTL-0102-001</b>
		Proprietary	Stainless steel V4A	Embeddable	RFID	-40 ... +125°C	-40 ... +125°C	<b>RTL-0162-001</b>
		Proprietary	Stainless steel V4A	Embeddable	RFID	-40 ... +125°C	-40 ... +125°C	<b>RTL-2162-001</b>
		Proprietary	Stainless steel V4A	Embeddable	RFID	-40 ... +125°C	-40 ... +125°C	<b>RTL-0262-001</b>
		Proprietary	Stainless steel V4A	Embeddable	RFID	-40 ... +125°C	-40 ... +125°C	<b>RTL-1302-001</b>
		Proprietary	Stainless steel V4A	Embeddable	RFID	-40 ... +125°C	-40 ... +125°C	<b>RTL-2302-001</b>





## APPLICATION

### RFID tags withstand elevated temperatures during automotive paint curing

Identification components in paint shops are exposed to a variety of rinsing, coating and burning operations, including electrophoresis. Since soiling makes visual identification difficult or impossible, rugged RFID systems are an excellent solution. The RFID tag accompanies each product throughout all painting processes. It can store individual data, including customer requirements, directly on the product or carrier. This allows highly automated customized processes, with smaller batches and central data storage.

## INDUSTRIES

Automotive production and supply, maritime, food and beverage



Paint shop in automotive industry



Maritime industry



Brewery production equipment



Automotive part sensing

# HIGH TEMPERATURE TAGS

## RFID

### READY TO BAKE

Designed for environments up to 180 or 250°C, **High Temperature** tags offer exceptional longevity and a thermal-cycling reliability of 1000 hours (or 1000 cycles). Tags are insensitive to dirt and provide between 112 and 2000 Bytes of user memory. As passive devices, no battery or other power source is required. Housings are impervious (IP68 and IP69K).

#### KEY ADVANTAGES

- ✓ High frequency, fully compatible with ISO/IEC 15693
- ✓ Exceptionally long life-expectancy, even under intense read/write and temperature cycling
- ✓ Insensitive to dirt

#### Ø26 mm, PPS housing

- ✓ Temperature range -25 ... +180°C (-13 ... +356°F)
- ✓ Embeddable in metal
- ✓ User memory size (EEPROM): 160 Byte

#### Ø50 mm, LCP housing

- ✓ Temperature range -25 ... +250°C (-13 ... +482°F)
- ✓ 100% silicone-free, ideal for paint-shop applications (LABS-free, PWIS-free)
- ✓ User memory size:
  - ✓ FRAM technology: 2000 Byte (RTP-0502-062)
  - ✓ EEPROM technology: 112 Byte (RTP-0502-082) and 160 Byte (RTP-0502-022)



#### PRODUCT OVERVIEW

Housing size mm	Ø26 mm	M30
Read/write distance max (mm)	12	12

#### ACCESSORIES

Go to page 290 to see all the accessories



# RFID HIGH TEMPERATURE

## OUTPUT

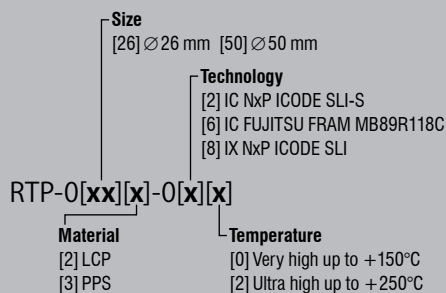

Reference key on pages 294–297

## ACCESSORIES

 **Starter kits**  
See page 292

 **Handheld devices**  
See page 292

 **RFID couplers**  
See page 293

 **Cables**  
See page 288

Go to page 298 for details



# RFID HIGH TEMPERATURE TRANSPONDERS

FAMILY	HOUSING SIZE (mm)	USER MEMORY SIZE (BYTE)	READ/WRITE DISTANCE MAX. (mm)
HIGH TEMPERATURE	Ø 26	160	31
	Ø 50	112	42.5
	Ø 50	160	50
	Ø 50	2000	44.5

HIGH TEMPERATURE



**KEY ADVANTAGES**

- ✓ High frequency, fully compatible with ISO/IEC 15693
- ✓ Exceptionally long life expectancy, even under intense read/write and temperature cycling
- ✓ Insensitive to dirt
- ✓ PWIS free

**Ø26 mm, PPS housing**

- ✓ Temperature range –25... +180°C (–13 ... +356°F)
- ✓ Embeddable in metal
- ✓ User memory size (EEPROM): 160 Byte

**Ø50 mm, LCP housing**

- ✓ Temperature range –25 ... +250°C (–13 ... +482°F)
- ✓ 100% silicone-free, ideal for paint-shop applications (LABS-free, PWIS-free)
- ✓ User memory size:
  - FRAM technology: 2000 Byte (RTP-0502-062)
  - EEPROM technology: 112 Byte (RTP-0502-082) and 160 Byte (RTP-0502-022)

	OPERATING FREQUENCY	STANDARD	HOUSING MATERIAL	MOUNTING	INTERFACE	STORAGE TEMPERATURE	AMBIENT TEMPERATURE	PART REFERENCE
		ISO/IEC 15693	PPS	Embeddable	RFID	–40 ... +180°C	–25 ... +180°C	<b>RTP-0263-020</b>
		ISO/IEC 15693	LCP (liquid crystal polymer)	Non-embeddable	RFID	–40 ... +250°C	–25 ... +150°C	<b>RTP-0502-082</b>
		ISO/IEC 15693	LCP (liquid crystal polymer)	Non-embeddable	RFID	–40 ... +250°C	–25 ... +150°C	<b>RTP-0502-022</b>
		ISO/IEC 15693	LCP (liquid crystal polymer)	Non-embeddable	RFID	–40 ... +250°C	–25 ... +150°C	<b>RTP-0502-062</b>



To bring overall system-integration cost down, an RFID interface is an ideal solution. It simplifies the software-integration effort, which typically represents up to 50% of the total implementation cost for a small project. Assuring shortened software-development time at a modest cost premium, Contrinex interfaces are ready to tackle the most demanding and time-critical tasks.

# INTERFACES

## RFID

### MARKET-LEADING FIELDBUS COVERAGE

#### KEY ADVANTAGES

- ✓ Widest fieldbus coverage on market
- ✓ Interfaces for connection of ContriNET to PROFIBUS, DeviceNet, EtherNet/IP, PROFINET, EtherCAT, POWERLINK and Ethernet TCP/IP
- ✓ Comprehensive accessories including T-connectors and line terminators
- ✓ TCP/IP interface in lightweight plastic, 120 × 80 × 30 mm



#### INTERFACES

- ✓ Compact, ready-to-use device
- ✓ Allows connection of ContriNET to an industrial fieldbus
- ✓ Synthetic housing in ABS
- ✓ Mounting on rail DIN EN 60715

#### USB ADAPTOR





- ✓ Synthetic ABS housing
- ✓ Serial RS-485 connection to ContriNET
- ✓ USB connection to control PC

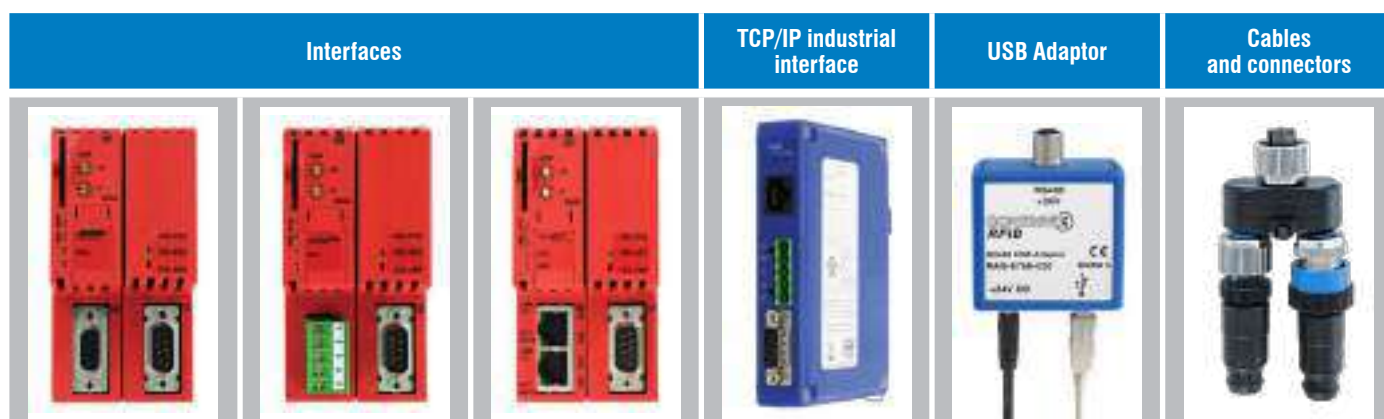

#### PRODUCT OVERVIEW



# RFID INTERFACES

	INDUSTRIAL INTERFACES FOR PLC			INDUSTRIAL INTERFACE FOR PC	USB ADAPTOR FOR PC
					
<b>FIELD BUS</b>	Profibus-DP	Devicenet	Ethernet/IP / Profinet IO Ethercat / Powerlink	Ethernet TCP/IP	USB
<b>HOUSING SIZE (mm)</b>	100 × 52 × 64	100 × 52 × 64	100 × 52 × 64	155 × 96 × 44	67 × 66 × 28
<b>HOUSING MATERIAL</b>	ABS	ABS	ABS	Metal	ABS
<b>MOUNTING</b>	DIN rail EN 60715	DIN rail EN 60715	DIN rail EN 60715	DIN rail EN 60715	–
<b>AMBIENT TEMPERATURE RANGE</b>	0 ... +50°C / +32 ... +122°F	0 ... +50°C / +32 ... +122°F	0 ... +50°C / +32 ... +122°F	–10 ... +80°C / –14 ... +176°F	0 ... +50°C / +32 ... +122°F
<b>STORAGE TEMPERATURE RANGE</b>	0 ... +50°C / +32 ... +122°F	0 ... +50°C / +32 ... +122°F	0 ... +50°C / +32 ... +122°F	–20 ... +85°C / –14 ... +185°F	–40 ... +85°C / –40 ... +185°F
<b>WEIGHT</b>	150 g	150 g	150 g	635 g	67 g
<b>POWER SUPPLY</b>	18 ... 30 V	18 ... 30 V	18 ... 30 V	10 ... 48 V	24 V
<b>MAX. CURRENT CONSUMPTION</b>	130 mA	130 mA	130 mA	160 mA	625 mA
<b>CONNECTION (RS-485 SIDE)</b>	Connector DB9	Connector DB9	Connector DB9	Terminal block	Connector S12
<b>PART REFERENCE</b>	RIS-1053-120	RIS-1053-220	RIS-1053-E20	RIS-1208-400	RAS-6766-020



# CONTRINET APPLICATION WITH INTERFACES

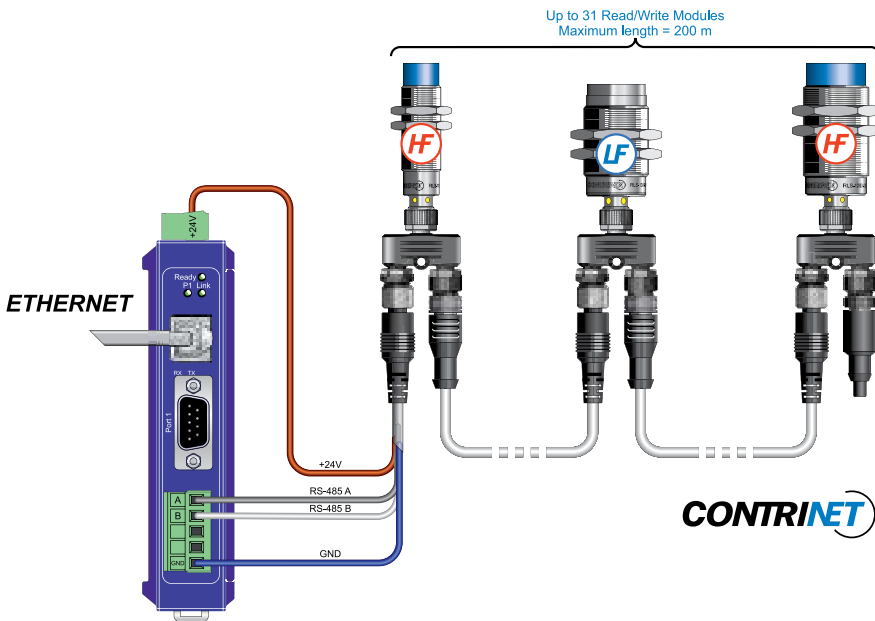
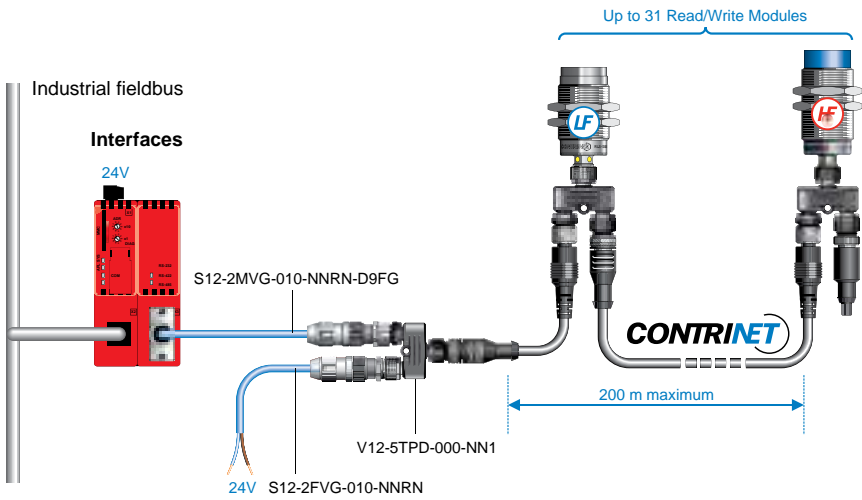

RIS-1208-400  
MINICONNECT

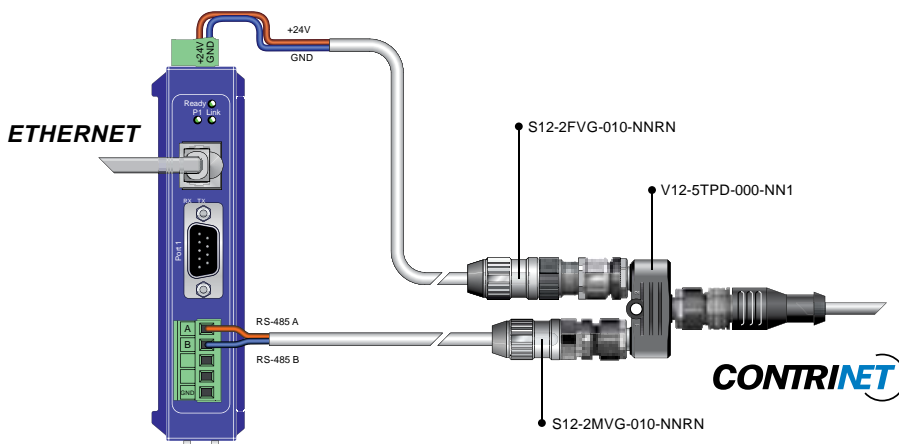

RIS-1208-400  
S12-2MVG

## ACCESSORIES TO CONNECT INTERFACES TO CONTRINET

S12-2MVG-010-NNR2-D9FG

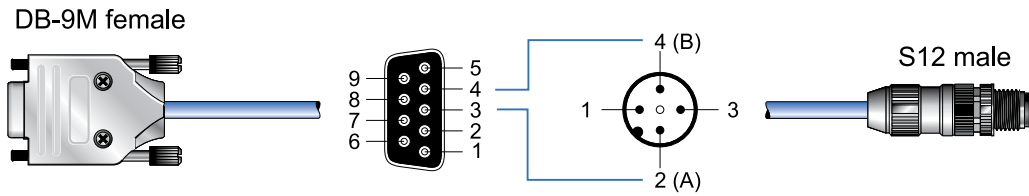

S12-2FVG-010-NNRN

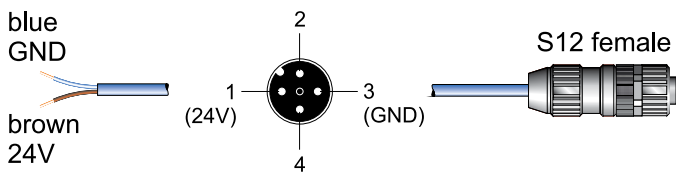

V12-5TPD-000-NN1

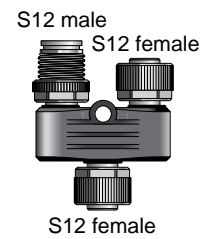

S12-2MVG-010-NNRN

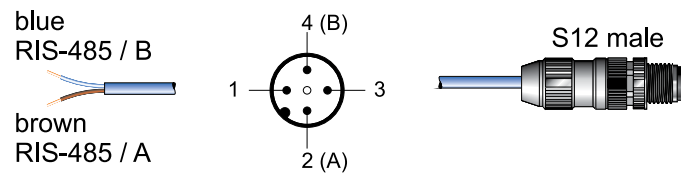

S12-5MNG-000-NNRN-120W



### DATA

S12-2MVG-010-NNRN-D9FG	DB9 – S12, RS-485 A/B cable – PVC 1 m
S12-2FVG-010-NNRN	24V – S12, power supply cable – PVC 1 m
S12-2MVG-010-NNRN	2-wire – S12, RS-485 A/B cable – PVC 1 m
V12-5TPD-000-NN1	S12 T-connector
S12-5MNG-000-NNRN-120W	S12 ContriNET terminator 120 Ω



## ACCESSORIES FOR USB INTERFACE

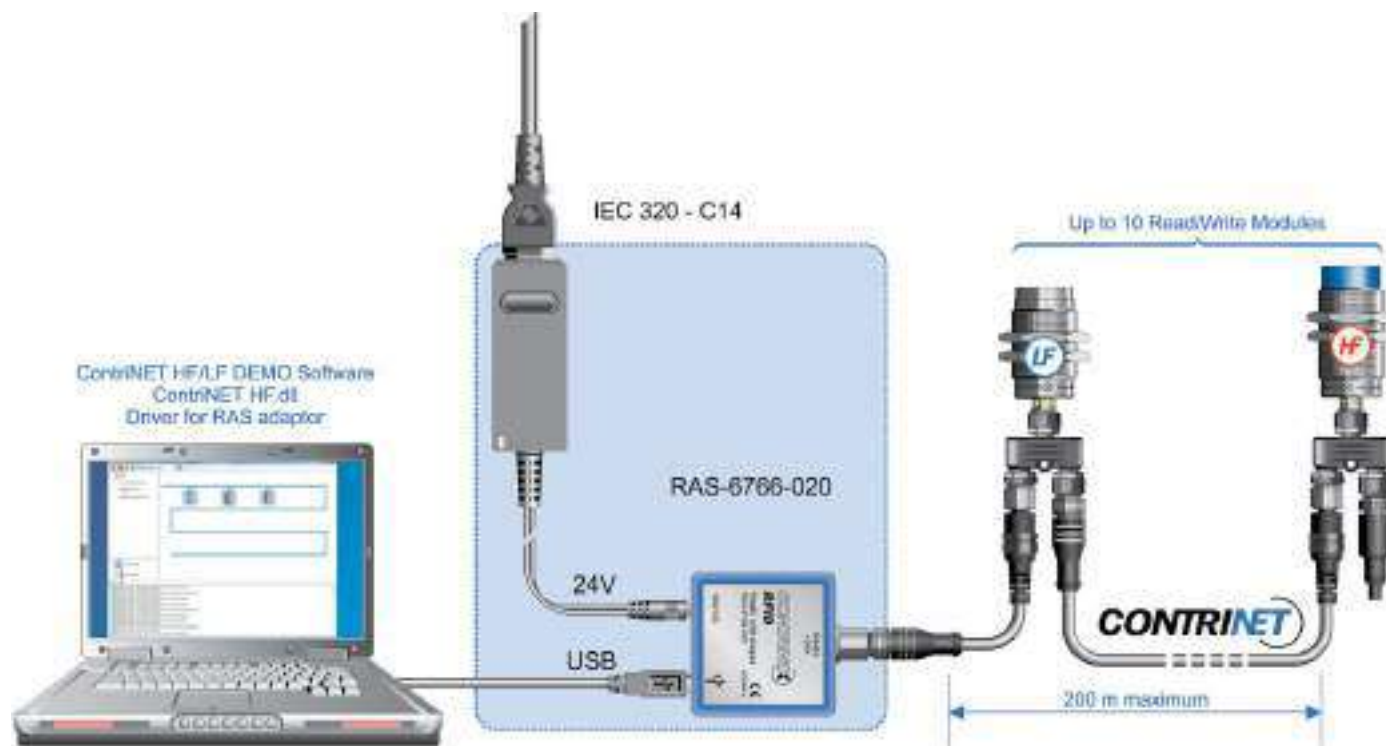

### CONNECTION

The adaptor acts as the interface between a network of Read/Write Modules and the USB port of the control PC. The delivery package includes a USB cable.

### EXTERNAL POWER SUPPLY UNIT

An external power supply unit (24V / 15W, 625 mA) is included in the delivery package.

### DRIVERS AND SOFTWARE

Drivers compatible with the various Windows versions and software for demonstration and training (Contrinet HF/LF) can be downloaded from the RAS-6766-020 product page of the Contrinex website.



Contrinex RFID accessories make it easy for system designers to develop simple applications from scratch. RFID Starter Kits, available with either LF or HF technology, contain all the elements needed to build a basic RFID system – including RWMs, transponders, cables, connectors and power supply – in a handy carry-case. For hard-to-reach applications where it's impossible to mount a powered RWM close to a tag, passive RFID couplers extend the sensing distance without the need for any physical connection. Optionally, for LF applications, a hand-held reader with an integral RWM offers a non-contact alternative.

# ACCESSORIES

## RFID

### KEY ADVANTAGES

#### STARTER-KIT RFID LF

- ✓ Set containing all the components needed to develop a simple LF RFID application
- ✓ 2 read/write modules (RWM)
- ✓ 6 transponders
- ✓ 1 USB adaptor with power supply
- ✓ Connection cables

#### STARTER-KIT RFID HF

- ✓ Set containing all the components needed to develop a simple HF RFID application
- ✓ 2 read/write modules (RWM)
- ✓ 5 transponders
- ✓ 1 USB adaptor with power supply
- ✓ Connection cables

#### HANDHELD DEVICE

- ✓ Portable and light
- ✓ No connector
- ✓ Robust and ergonomic housing
- ✓ Simple navigation
- ✓ Integrated RFID read/write module
- ✓ Belt clip
- ✓ Integrated clock and calendar
- ✓ Dock-in/charging station included

#### RFID COUPLERS



- ✓ Metal threaded cylindrical housings
- ✓ Sensing face of PBTP (polybutylene terephthalate) or stainless steel V2A
- ✓ Insensitive to dirt
- ✓ Passive (without power supply)



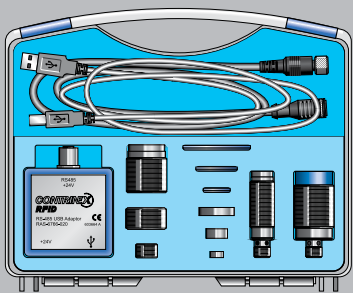

### PRODUCT OVERVIEW

Starter kits		Handheld device	RFID couplers
			

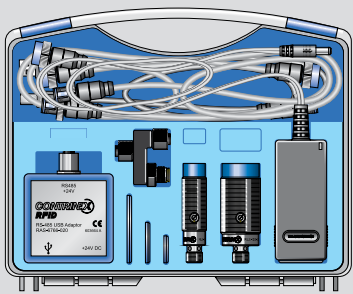
## STARTER KITS



STARTER KITS	HOUSING SIZE (mm)	CONTENTS
 STARTER-KIT RFID	 255 × 205 × 60	1 USB adaptor, 2 RWMs, 6 tags, 2 T-connectors, 1 power supply, 1 USB cable, 2 connecting cables
 STARTER-KIT RFID	 255 × 205 × 60	1 USB adaptor, 2 RWMs, 5 tags, 2 T-connectors, 1 power supply, 1 USB cable, 2 connecting cables

## HANDHELD DEVICE

 HANDHELD DEVICE	HOUSING SIZE (mm)	PART REFERENCE	
	155 × 75 × 49 (with docking station)	RPA-0111-000	Handheld read/write device with docking station with EU adapter
		RPA-0110-000	Handheld read/write device without docking station
		RPA-0101-000	Docking station with EU adapter
		RPA-0112-000	Handheld read/write device with docking station with US adapter
		RPA-0102-000	Docking station with US adapter

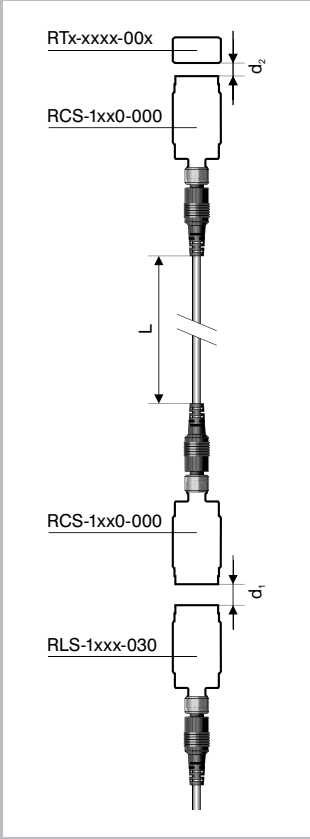
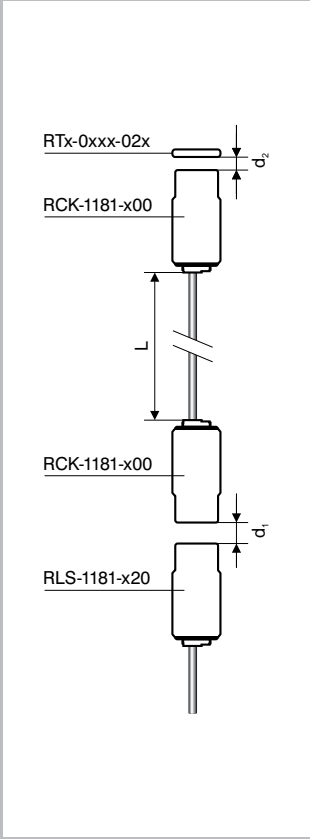

## RFID COUPLERS

DATA		
		
HOUSING SIZE	M18/M30	M18
HOUSING MATERIAL	Stainless steel V2A/Chrome-plated brass	Chrome-plated brass
SENSING FACE MATERIAL	Stainless steel V2A/PBTP	PBTP
MOUNTING	Non-embeddable	Non-embeddable
AMBIENT TEMPERATURE RANGE	-25 ... +80°C / -13 ... +176°F	-25 ... +80°C / -13 ... +176°F
STORAGE TEMPERATURE RANGE	-25 ... +80°C / -13 ... +176°F	-25 ... +80°C / -13 ... +176°F
CONNECTION TYPE	Connector S12	PVC cable, 2 m
DEGREE OF PROTECTION	IP68 & IP69K/IP67	IP67
WEIGHT (WITH NUTS)	51 g/120 g	80 g
PART REFERENCE	RCS-1180-000 RCS-1181-000 RCS-1300-000 RCS-1301-000	RCK-1181-020

## NEW RFID DESIGNATION

### RLH-C44PA-NIS

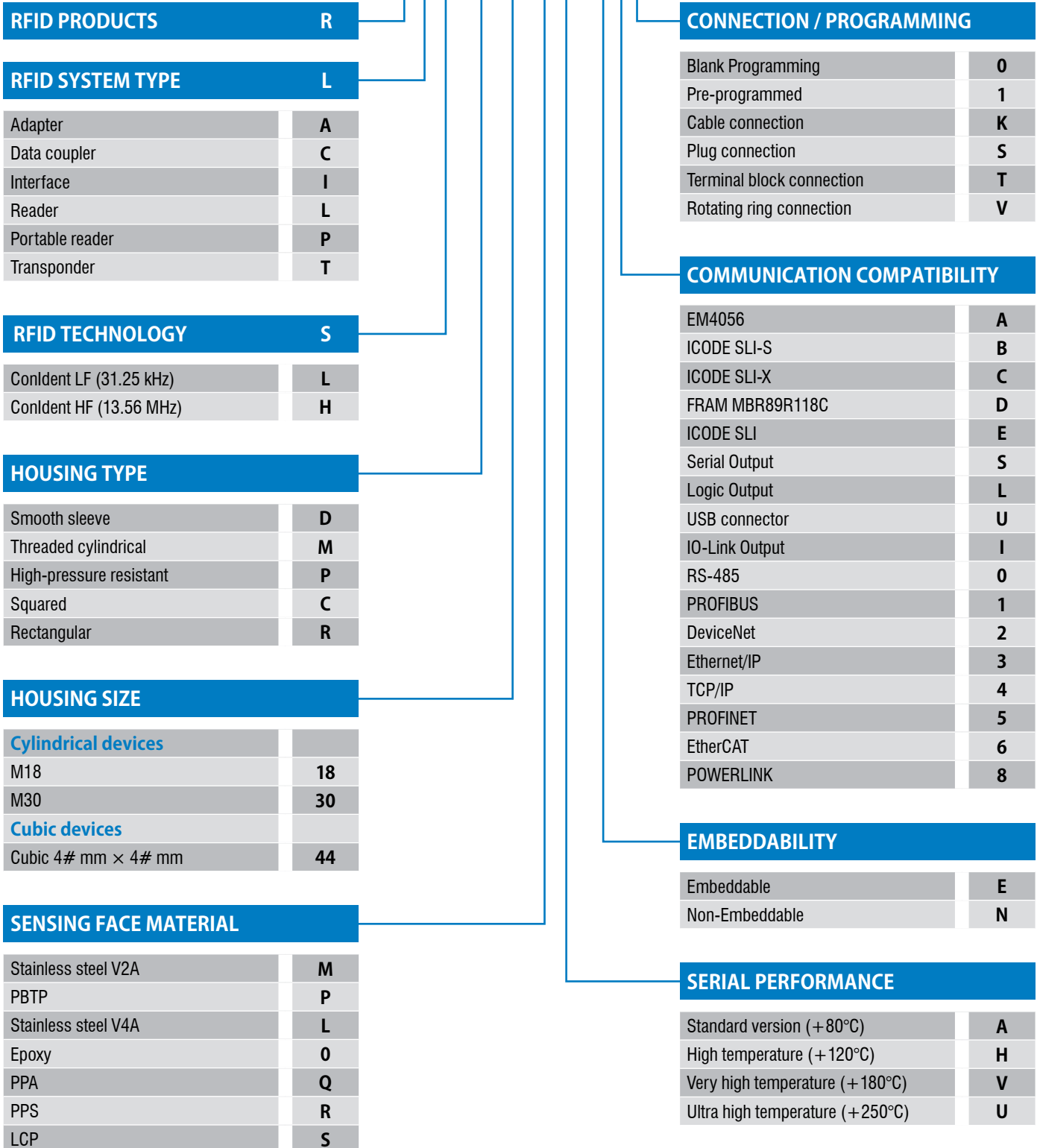

#### RFID PRODUCTS

Adapter	A
Data coupler	C
Interface	I
Reader	L
Portable reader	P
Transponder	T

#### RFID TECHNOLOGY

Conclent LF (31.25 kHz)	L
Conclent HF (13.56 MHz)	H

#### HOUSING TYPE

Smooth sleeve	D
Threaded cylindrical	M
High-pressure resistant	P
Squared	C
Rectangular	R

#### HOUSING SIZE

<b>Cylindrical devices</b>	
M18	18
M30	30
<b>Cubic devices</b>	
Cubic 4# mm × 4# mm	44

#### SENSING FACE MATERIAL

Stainless steel V2A	M
PBTP	P
Stainless steel V4A	L
Epoxy	0
PPA	Q
PPS	R
LCP	S

#### CONNECTION / PROGRAMMING

Blank Programming	0
Pre-programmed	1
Cable connection	K
Plug connection	S
Terminal block connection	T
Rotating ring connection	V

#### COMMUNICATION COMPATIBILITY

EM4056	A
ICODE SLI-S	B
ICODE SLI-X	C
FRAM MBR89R118C	D
ICODE SLI	E
Serial Output	S
Logic Output	L
USB connector	U
IO-Link Output	I
RS-485	0
PROFIBUS	1
DeviceNet	2
Ethernet/IP	3
TCP/IP	4
PROFINET	5
EtherCAT	6
POWERLINK	8

#### EMBEDDABILITY

Embeddable	E
Non-Embeddable	N

#### SERIAL PERFORMANCE

Standard version (+80°C)	A
High temperature (+120°C)	H
Very high temperature (+180°C)	V
Ultra high temperature (+250°C)	U



TRANSPONDERS

# RTM-0160-000

**RFID PRODUCT** R

**TRANSPONDER** T

**SERIES**

All metal	F
All metal, laser welded	L
Metal	M
Plastic	P

**TYPE**

Smooth sleeve	0
Non-embeddable	1
Embeddable	2

**SIZE**

Diameter [mm]	XX
---------------	----

**TEMPERATURE**

Standard up to +80°C	0
High up to +125°C	1
Ultra high up to +250°C	2

**TECHNOLOGY**

Low Frequency	0
High Frequency – ISO 15693 IC NxP ICODE SLI-S	2
High Frequency – ISO 15693 IC Fujitsu FRAM MBR89	6
High Frequency – ISO 15693 IC NxP ICODE SLI	8

**PROGRAMMING**

Blank	0
Preprogrammed	1

**MATERIAL**

Epoxy	0
PBTP	1
LCP	2
PPS	3

## INTERFACES

### RIS-1053-120

#### RFID PRODUCTS

R

#### MODULE

Adaptor	A
Interface	I

#### CONNECTOR

S

#### SIZE

<b>RAS</b>	
66 × 67 mm	6766
<b>RIS</b>	
100 × 52 × 64 mm	105

#### CONNECTIVITY

Fieldbus / ContriNet	3
----------------------	---

#### COMMAND SET

Standard	0
----------	---

#### PROTOCOL

ContriNet	2
-----------	---

#### FIELDBUS

<b>RAS</b>	
USB	0
<b>RIS</b>	
PROFIBUS-DP	1
DeviceNet	2
EtherNet/IP	3
PROFINet IO	5
EtherCAT	6
POWERLINK	8
TCP/IP	400



READ/WRITE MODULES

RLS-1181-030

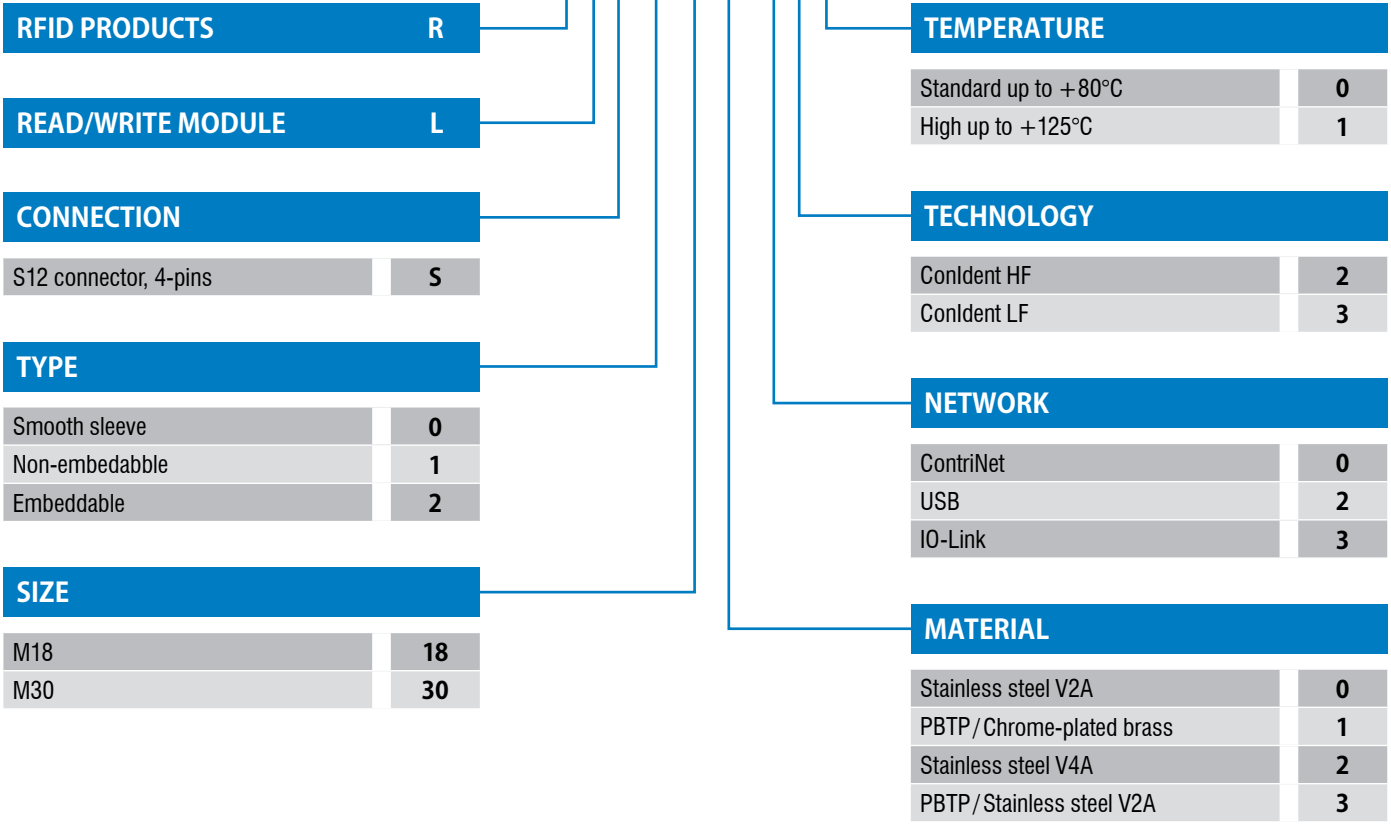

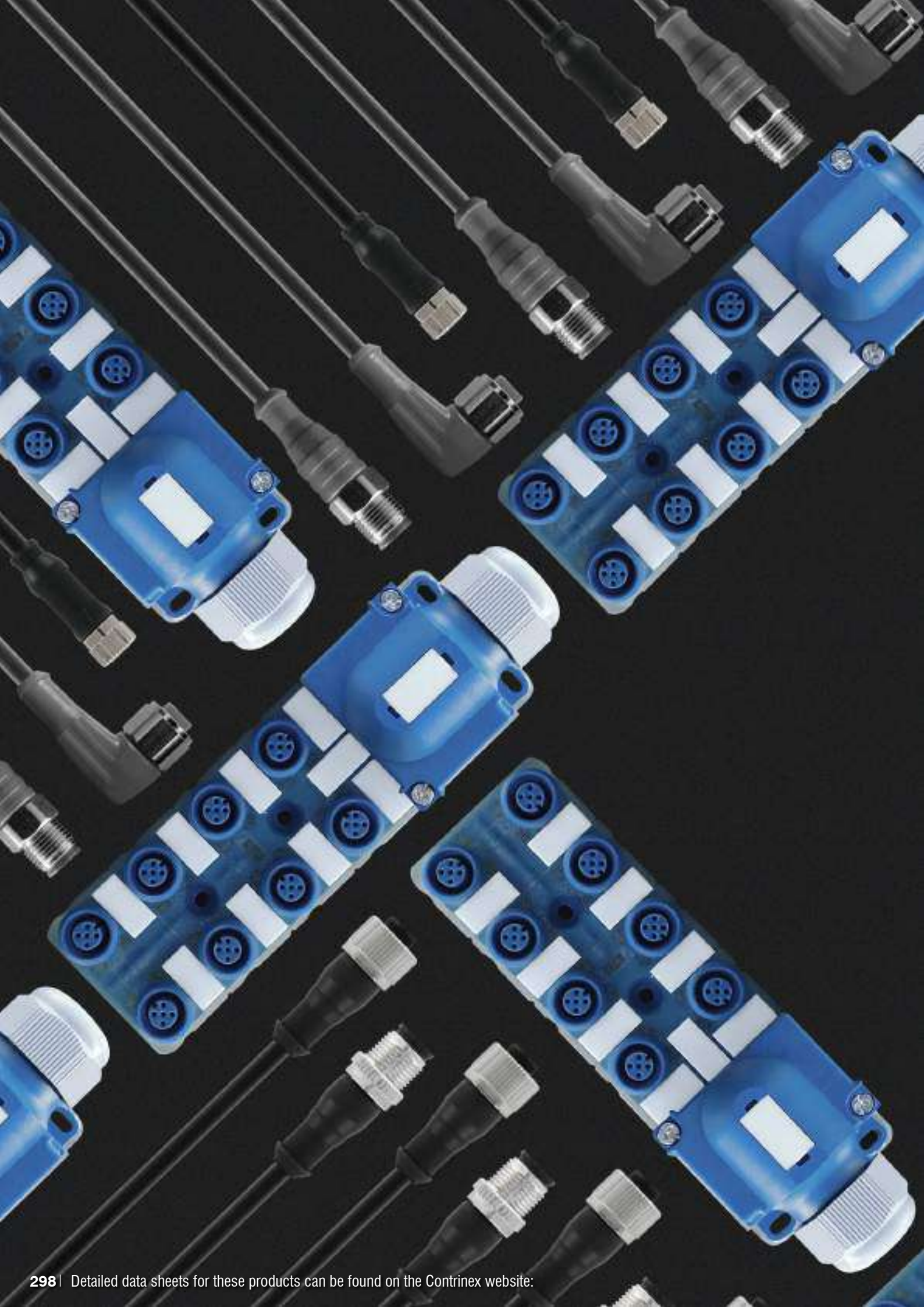



# ACCESSORIES

## HIGHLIGHTS

- ✓ Comprehensive cable and connector program
- ✓ IP69K and Ecolab-certified cables for the food and beverage industry (on demand)
- ✓ UL-approved cables and connectors
- ✓ Cables with straight or right-angle sockets
- ✓ Distribution boxes
- ✓ Field-attachable connectors
- ✓ T-connectors (on demand)
- ✓ User-friendly standard portfolio
- ✓ Sensor testers for fast field checks
- ✓ Sensor mounting clamps
- ✓ Bases for mounting clamps
- ✓ Mechanical stops
- ✓ Amplifiers for 3-wire and NAMUR sensors (on demand)

## INDUCTIVE & PHOTOELECTRIC CABLES

### Group A

#### M8 3-PIN



open ended wire







connecting cables

CONNECTOR	PINS	CONFIG.	CABLE MATERIAL	CABLE LENGTH	WIRE	CABLE CONNECTION END	PINS	PART REFERENCE
M8	3-pole	straight	PUR	2 m	3	OPEN CABLE	–	S08-3FUG-020
M8	3-pole	straight	PUR	5 m	3	OPEN CABLE	–	S08-3FUG-050
M8	3-pole	straight	PUR	10 m	3	OPEN CABLE	–	S08-3FUG-100
M8	3-pole	right angle	PUR	2 m	3	OPEN CABLE	–	S08-3FUW-020
M8	3-pole	right angle	PUR	5 m	3	OPEN CABLE	–	S08-3FUW-050
M8	3-pole	right angle	PUR	10 m	3	OPEN CABLE	–	S08-3FUW-100
M8	3-pole	straight	PVC	2 m	3	OPEN CABLE	–	S08-3FVG-020
M8	3-pole	straight	PVC	5 m	3	OPEN CABLE	–	S08-3FVG-050
M8	3-pole	straight	PVC	10 m	3	OPEN CABLE	–	S08-3FVG-100
M8	3-pole	right angle	PVC	2 m	3	OPEN CABLE	–	S08-3FWW-020
M8	3-pole	right angle	PVC	5 m	3	OPEN CABLE	–	S08-3FWW-050
M8	3-pole	right angle	PVC	10 m	3	OPEN CABLE	–	S08-3FWW-100
M8	3-pole	straight	PUR	0.6 m	–	M8	3	S08-3FUG-006-08MG
M8	3-pole	straight	PUR	2 m	–	M8	3	S08-3FUG-020-08MG
M8	3-pole	straight	PUR	5 m	–	M8	3	S08-3FUG-050-08MG
M8	3-pole	straight	PVC	0.6 m	–	M8	3	S08-3FVG-006-08MG
M8	3-pole	straight	PVC	2 m	–	M8	3	S08-3FVG-020-08MG
M8	3-pole	straight	PVC	5 m	–	M8	3	S08-3FVG-050-08MG











## FIELD ATTACHABLE CONNECTORS

CONNECTOR	PINS	CONFIG.	OUTER Ø	WIRE Ø	PART REFERENCE
 M8	3-pole	straight	3.0–5.0	0.08–0.38	S08-3FNG-000-NNT1
 M8	3-pole	straight	4.0–8.0	0.14–0.50	S08-3FNG-000-NNT2
 M8	3-pole	straight	3.0–5.0	0.08–0.38	S08-3MNG-000-NNT1
 M8	3-pole	straight	4.0–8.0	0.14–0.50	S08-3MNG-000-NNT2



## DISTRIBUTION BOXES

CONNECTOR	PINS	NUMBER OF CONNECTIONS	CONNECTION TYPE	PART REFERENCE
 M8	3-pole	Universal – Hood	No cable	V08-30PE-000-NNN
 M8	3-pole	10 Plug Distribution box	PUR cable 5 m	V08-31PD-050-UYN
 M8	3-pole	10 Outputs – Hood	PUR cable 5 m	V08-31PH-050-UNN
 M8	3-pole	4 Plug Distribution box	No cable (hood needed)	V08-34PB-000-NYN
 M8	3-pole	4 Plug Distribution box	PUR cable 5 m	V08-34PD-050-UYN
 M8	3-pole	8 Plug Distribution box	No cable (hood needed)	V08-38PB-000-NYN
 M8	3-pole	8 Plug Distribution box	PUR cable 5 m	V08-38PD-050-UYN
 M8	3-pole	8 Outputs – Hood	PUR cable 5 m	V08-38PH-050-UNN



## INDUCTIVE & PHOTOELECTRIC CABLES

### Group B

#### M8 4-PIN



open ended wire



connecting cables

CONNECTOR	PINS	CONFIG.	CABLE MATERIAL	CABLE LENGTH	WIRE	CABLE CONNECTION END	PINS	PART REFERENCE
M8	4-pole	straight	PUR	2 m	4	OPEN CABLE	–	S08-4FUG-020
M8	4-pole	straight	PUR	5 m	4	OPEN CABLE	–	S08-4FUG-050
M8	4-pole	straight	PUR	10 m	4	OPEN CABLE	–	S08-4FUG-100
M8	4-pole	right angle	PUR	2 m	4	OPEN CABLE	–	S08-4FUW-020
M8	4-pole	right angle	PUR	5 m	4	OPEN CABLE	–	S08-4FUW-050
M8	4-pole	right angle	PUR	10 m	4	OPEN CABLE	–	S08-4FUW-100
M8	4-pole	straight	PVC	2 m	4	OPEN CABLE	–	S08-4FVG-020
M8	4-pole	straight	PVC	5 m	4	OPEN CABLE	–	S08-4FVG-050
M8	4-pole	straight	PVC	10 m	4	OPEN CABLE	–	S08-4FVG-100
M8	4-pole	right angle	PVC	2 m	4	OPEN CABLE	–	S08-4FVW-020
M8	4-pole	right angle	PVC	5 m	4	OPEN CABLE	–	S08-4FVW-050
M8	4-pole	right angle	PVC	10 m	4	OPEN CABLE	–	S08-4FVW-100
M8	4-pole	straight	PUR	2 m	–	M12	4	S08-4FUG-020-12MG
M8	4-pole	right angle	PUR	2 m	–	M8	4	S08-4FUW-020-08MG
M8	4-pole	straight	PVC	2 m	–	M12	4	S08-4FVG-020-12MG
M8	4-pole	right angle	PVC	2 m	–	M8	4	S08-4FVW-020-08MG



# INDUCTIVE & PHOTOELECTRIC CABLES

## Group C

### M12 4-PIN



open ended wire













connecting cables

CONNECTOR	PINS	CONFIG.	CABLE MATERIAL	CABLE LENGTH	WIRE	CABLE CONNECTION END	PINS	PART REFERENCE
M12	4-pole	straight	PUR	2 m	4	OPEN CABLE	–	S12-4FUG-020
M12	4-pole	straight	PUR	5 m	4	OPEN CABLE	–	S12-4FUG-050
M12	4-pole	straight	PUR	10 m	4	OPEN CABLE	–	S12-4FUG-100
M12	4-pole	straight	PUR	15 m	4	OPEN CABLE	–	S12-4FUG-150
M12	4-pole	straight	PUR	20 m	4	OPEN CABLE	–	S12-4FUG-200
M12	4-pole	straight	PUR	25 m	4	OPEN CABLE	–	S12-4FUG-250
M12	4-pole	right angle	PUR	2 m	4	OPEN CABLE	–	S12-4FUW-020
M12	4-pole	right angle	PUR	5 m	4	OPEN CABLE	–	S12-4FUW-050
M12	4-pole	right angle	PUR	10 m	4	OPEN CABLE	–	S12-4FUW-100
M12	4-pole	right angle	PUR	15 m	4	OPEN CABLE	–	S12-4FUW-150
M12	4-pole	right angle	PUR	20 m	4	OPEN CABLE	–	S12-4FUW-200
M12	4-pole	right angle	PUR	25 m	4	OPEN CABLE	–	S12-4FUW-250
M12	4-pole	straight	PVC	2 m	4	OPEN CABLE	–	S12-4FVG-020
M12	4-pole	straight	PVC	5 m	4	OPEN CABLE	–	S12-4FVG-050
M12	4-pole	straight	PVC	10 m	4	OPEN CABLE	–	S12-4FVG-100
M12	4-pole	right angle	PVC	2 m	4	OPEN CABLE	–	S12-4FVW-020
M12	4-pole	right angle	PVC	5 m	4	OPEN CABLE	–	S12-4FVW-050
M12	4-pole	right angle	PVC	10 m	4	OPEN CABLE	–	S12-4FVW-100
M12	4-pole	straight	PUR	0.6 m	–	M12	4	S12-4FUG-006-12MG
M12	4-pole	straight	PUR	2 m	–	M12	4	S12-4FUG-020-12MG
M12	4-pole	straight	PUR	5 m	–	M12	4	S12-4FUG-050-12MG
M12	4-pole	straight	PVC	0.6 m	–	M12	4	S12-4FVG-006-12MG
M12	4-pole	straight	PVC	2 m	–	M12	4	S12-4FVG-020-12MG
M12	4-pole	straight	PVC	5 m	–	M12	4	S12-4FVG-050-12MG

## INDUCTIVE & PHOTOELECTRIC CABLES

### Group C

#### FIELD ATTACHABLE CONNECTORS

CONNECTOR	PINS	CONFIG.	OUTER Ø	WIRE Ø	PART REFERENCE
 M12	3-pole	straight	3.0–5.0	0.08–0.38	S12-3FNG-000-NNT1
 M12	3-pole	straight	3.0–5.0	0.08–0.38	S12-3MNG-000-NNT1
 M12	4-pole	straight	3.0–5.0	0.08–0.38	S12-4FNG-000-NNT1
 M12	4-pole	straight	4.0–8.0	0.14–0.50	S12-4FNG-000-NNT2
 M12	4-pole	straight	5.5–8.0	0.50–1.00	S12-4FNG-000-NNT3
 M12	4-pole	right angle	3.0–5.0	0.08–0.38	S12-4FNW-000-NNT1
 M12	4-pole	straight	3.0–5.0	0.08–0.38	S12-4MNG-000-NNT1
 M12	4-pole	straight	4.0–8.0	0.14–0.50	S12-4MNG-000-NNT2
 M12	4-pole	straight	5.5–8.0	0.50–1.00	S12-4MNG-000-NNT3
 M12	4-pole	right angle	3.0–5.0	0.08–0.38	S12-4MNW-000-NNT1





## DISTRIBUTION BOXES

CONNECTOR	PINS	NUMBER OF CONNECTIONS	CONNECTION TYPE	PART REFERENCE
 M12	5-pole	Universal – Hood	No cable	V12-50PE-000-NNN
 M12	5-pole	4 Plug Distribution box	Connector M23	V12-54MG-023-NYN
 M12	5-pole	4 Plug Distribution box	No cable (hood needed)	V12-54PB-000-NYN
 M12	5-pole	4 Plug Distribution box	PUR cable 2 m	V12-54PD-020-UYN
 M12	5-pole	4 Plug Distribution box	PUR cable 5 m	V12-54PD-050-UYN
 M12	5-pole	4 Plug Distribution box	PUR cable 10 m	V12-54PD-100-UYN
 M12	5-pole	4 Plug Distribution box + Hood	PUR cable 5 m	V12-54PY-050-UYN
 M12	5-pole	8 Plug Metal Distribution box	PUR cable 5 m	V12-58MD-050-UYN
 M12	5-pole	8 Plug Metal Distribution box	PUR cable 10 m	V12-58MD-100-UYN
 M12	5-pole	8 Plug Metal Distribution box	Connector M23	V12-58MG-023-NYN
 M12	5-pole	8 Plug Distribution box	No cable (hood needed)	V12-58PB-000-NYN
 M12	5-pole	8 Plug Distribution box	PUR cable 2 m	V12-58PD-020-UYN
 M12	5-pole	8 Plug Distribution box	PUR cable 5 m	V12-58PD-050-UYN
 M12	5-pole	8 Plug Distribution box	PUR cable 10 m	V12-58PD-100-UYN
 M12	5-pole	8 Plug Distribution box + Hood	PUR cable 2 m	V12-58PY-020-UYN
 M12	5-pole	8 Plug Distribution box + Hood	PUR cable 5 m	V12-58PY-050-UYN







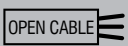

## INDUCTIVE & PHOTOELECTRIC CABLES

### Group D

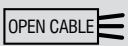
#### M12 AC/DC 3-PIN

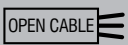

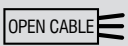

CONNECTOR	PINS	CONFIG.	CABLE MATERIAL	CABLE LENGTH	WIRE	CABLE CONNECTION END	PINS	PART REFERENCE
 UNF 1/2"	3	straight	PUR	2 m	3		–	S13-3FUG-020
 UNF 1/2"	3	straight	PUR	5 m	3		–	S13-3FUG-050
 UNF 1/2"	3	right angle	PUR	2 m	3		–	S13-3FUW-020
 UNF 1/2"	3	right angle	PUR	5 m	3		–	S13-3FUW-050





# UNIVERSAL MOUNTING BRACKETS

## Group E

### UNIVERSAL MOUNTING BRACKETS

	HOUSING SIZE COMPATIBILITY	TYPE	PART REFERENCE
	∅ 3	without limit stop	ASU-0001-030
	∅ 4	without limit stop	ASU-0001-040
	∅ 5	without limit stop	ASU-0001-050
	∅ 6.5	without limit stop	ASU-0001-065
	∅ 8	without limit stop	ASU-0001-080
	∅ 8	with limit stop	ASU-0002-080
	∅ 12 mm	without limit stop	ASU-0001-120
	∅ 12 mm	with limit stop	ASU-0002-120
	∅ 18 mm	without limit stop	ASU-0001-180
	∅ 18 mm	with limit stop	ASU-0002-180

### MECHANICAL STOPS

	INNER ∅	OUTER ∅	PLUNGER TYPE	MAX. FORCE ON HOUSING	MAX. FORCE ON PLUNGER	PART REFERENCE
	M5 × 0.5	M8 × 1	Flat <sup>1</sup>	8,000 N	2,000 N	AMS-0001-M08
	M5 × 0.5	M8 × 1	Spherical <sup>2</sup>	8,000 N	2,000 N	AMS-0002-M08
	M8 × 1	M12 × 1	Flat <sup>1</sup>	15,000 N	2,000 N	AMS-0001-M12
	M8 × 1	M12 × 1	Spherical <sup>2</sup>	15,000 N	2,000 N	AMS-0002-M12

**Material:** Steel XC 48, black  
**Max. tightening torque:** 30 Nm (M8), 50 Nm (M12)

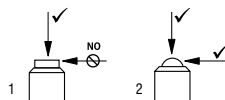

## PHOTOELECTRIC MOUNTING BRACKETS

### Group F

	HOUSING SIZE COMPATIBILITY	BRACKET MATERIAL	PART REFERENCE
	C23PA series	Stainless steel V2A	LXW-C23PA-000
	C23PA series	Stainless steel V2A	LXW-C23PA-001
	C23PA series	Stainless steel V2A	LXW-C23PA-002
	C23PA series	Stainless steel V2A	LXW-C23PA-003
	DGI series MGI series	Stainless steel V2A	LXW-DGMGA-000











	HOUSING SIZE COMPATIBILITY	BRACKET MATERIAL	PART REFERENCE
	M18PA series	ABS/PMMA	LHW-M18PA-000
	M18PA series	ABS/PMMA	LLW-M18PA-000
	M18PA series	ABS/PMMA	LTW-M18PA-000
	M18PA series	ABS	LXW-M18PA-000
	M18PA series	Polyamide	LXW-M18PA-001

## PHOTOELECTRIC REFLECTORS

### Group G

#### REFLECTORS

	DIMENSIONS	PART REFERENCE
	Ø26 mm	LXR-0000-025
	Ø46 mm	LXR-0000-046
	Ø82 mm	LXR-0000-084
	32 × 20 mm	LXR-0001-032
	60 × 20 mm	LXR-0001-062
	Ø26 mm	LXU-0000-025
	Ø82 mm	LXU-0000-084
	32 × 20 mm	LXU-0001-032
	60 × 41 mm	LXU-0001-064



# SENSOR TESTER

## Group H

	PART REFERENCE
	ATE-0000-010

# ACCESSORIES REFERENCE KEY

## CABLES / CONNECTORS

### S12-4FAG-020[-NNLN-12MG]

#### CONNECTION CABLE

S

#### CONNECTOR SIZE FEMALE

M8	08
M12	12
M12 AC/DC	13
M23	23

#### NUMBER OF POLES

3-pole	3
4-pole	4
5-pole	5
8-pole	8
11-pole	B
19-pole	J

#### CONNECTOR TYPE

Female (socket)	F
Male (plug)	M

#### CABLE MATERIAL

No cable	N
PVC	V
PUR	U
TPE-S	A

#### CABLE EXIT (FEMALE)

Straight	G
Right-angle	W

#### CABLE LENGTH

No cable	000
0.3 m	003
0.6 m	006
1 m	010
1.5 m	015
2 m (standard)	020
5 m	050
10 m	100
15 m	150
20 m	200
25 m	250

#### CABLE EXIT (MALE)

Straight	G
Right-angle	W

#### CONNECTOR TYPE

Male (plug)	M
Female (socket)	F

#### CONNECTOR SIZE MALE

M8	08
M12	12
M23	23

#### CONNECTION TYPE

Standard	N
Quick-lock	Q
Cable Ø 3.0–5.0 mm / wire 0.08–0.38 mm <sup>2</sup>	1
Cable Ø 4.0–8.0 mm / wire 0.14–0.50 mm <sup>2</sup>	2
Cable Ø 5.5–8.0 mm / wire 0.5–1.0 mm <sup>2</sup>	3

#### APPLICATION

Standard	N
Food	L
RFID	R
Field attachable	T
Safety	S

#### EXECUTION

Standard or no cable	N
Shielded	W

#### LED

Yes, PNP	Y
Yes, NPN	Z
No	N



DISTRIBUTION BOXES AND T-CONNECTORS

# V12-58PD-050-UYN (-###)

## DISTRIBUTION BOX OR T-CONNECTOR

V

## CONNECTIONS

Accessory	00
M8	08
M12	12

## POLE NUMBER OF CONNECTIONS

3-pole	3
4-pole	4
5-pole	5
8-pole	8

## NUMBER OF CONNECTIONS

Hood for all types	0
2 connections	T
4 connections	4
6 connections	6
8 connections	8
10 connections	1

## MATERIAL

Plastic	P
Metal	M

## TYPE

Distribution box with cable / T-connector	D
Distribution box for straight connection	G
Distribution box for right-angle connection	W
Base element without hood	B
Hood with cable	H
Hood without cable	E
Base element + hood with cable	Y

## SPECIAL EXECUTIONS

### TECHNOLOGY

Standard (passive distribution box)	N
Wiring according diagram no.	#

### LED

Yes	Y
No	N

### CABLE MATERIAL

No cable	N
PVC	V
PUR	U

### CONNECTION

No cable	000
Cable 0.3 m	003
Cable 2 m	020
Cable 5 m	050
Cable 10 m	100
Connector M12	012
Connector M23	023

# ACCESSORIES REFERENCE KEY

## MISCELLANEOUS

### APT-0001-010

#### ACCESSORY A

#### ACCESSORY TYPE

Mechanical stop	MS
Protective tube	PT
Tester	TE

#### MATERIAL

Protective tubes, Tester	
Material PTFE, spiral, split	000

#### DIMENSIONS

<b>Mechanical stops</b>	
Outer diameter M08=M8 × 1 thread	M08
Outer diameter M12=M12 × 1 thread	M12
<b>Protective tubes</b>	
Length in dm (1 m)	010
Length in dm (10 m)	100

#### SERIES

<b>Mechanical stops</b>	
Flat plunger	1
Spheric plunger	2
<b>Protective tubes</b>	
Inner Ø3.5 mm / Outer Ø6.0 mm	0
Inner Ø6.5 mm / Outer Ø10.0 mm	1
Inner Ø13.0 mm / Outer Ø17.5 mm	2
Inner Ø19.0 mm / Outer Ø23.5 mm	3
<b>Tester</b>	
Base	0

## PHOTOELECTRIC MOUNTING BRACKETS AND SPECIAL MOUNTINGS

### LXW-C23PA-000

#### PHOTOELECTRIC SENSOR L

#### SENSOR TYPE

With background suppression	H
Through-beam sensor	L
Diffuse sensor	T
Accessories	X

#### DEVICE TYPE

Mounting bracket	W
------------------	---

#### HOUSING SIZE COMPATIBILITY

C23PA series	C23PA
DGI, MGI series	DGM
M18PA series	M18PA

#### INCREMENTAL NUMBER

Incremental number	000
Incremental number	001
Incremental number	002
Incremental number	003

#### PERFORMANCE

Standard	A, B
----------	------

#### HOUSING MATERIAL

Stainless steel V4A	G
Plastic	P



MOUNTING BRACKETS

ASU-0001-030

ACCESSORY **A**

ACCESSORY TYPE

Mounting brackets	<b>SU</b>
-------------------	-----------

FIXTURE

Standard Basic fixture	<b>00</b>
Standard Cylindrical fixture	<b>30</b>

MATERIAL

Plastic	<b>0</b>
Stainless steel V2A	<b>1</b>
Coated steel	<b>4</b>

DIMENSIONS

Ø 3 mm	<b>030</b>
Ø 4 mm	<b>040</b>
Ø 5 mm	<b>050</b>
Ø 6.5 mm	<b>065</b>
Ø 8 mm	<b>080</b>
Ø 12 mm	<b>120</b>
Ø 18 mm	<b>180</b>
Ø 30 mm	<b>300</b>

TYPE

Without limit stop	<b>1</b>
With limit stop	<b>2</b>
For C44	<b>3</b>
For 4#5#	<b>4</b>
For C1717	<b>5</b>

PHOTOELECTRIC REFLECTORS

LXR-0000-025

PHOTOELECTRIC SENSOR **L**

SENSOR TYPE

Accessories	<b>X</b>
-------------	----------

DEVICE TYPE

Reflector	<b>R</b>
Reflector for UV	<b>U</b>

SHAPE

Cylindrical reflector	<b>0000</b>
Rectangular reflector	<b>0001</b>

DIMENSIONS

<b>Cylindrical reflectors</b>	
Ø 26 mm	<b>025</b>
Ø 46 mm	<b>046</b>
Ø 82 mm	<b>084</b>
<b>Rectangular reflectors</b>	
32 × 20 mm	<b>032</b>
60 × 20 mm	<b>062</b>
60 × 41 mm	<b>064</b>

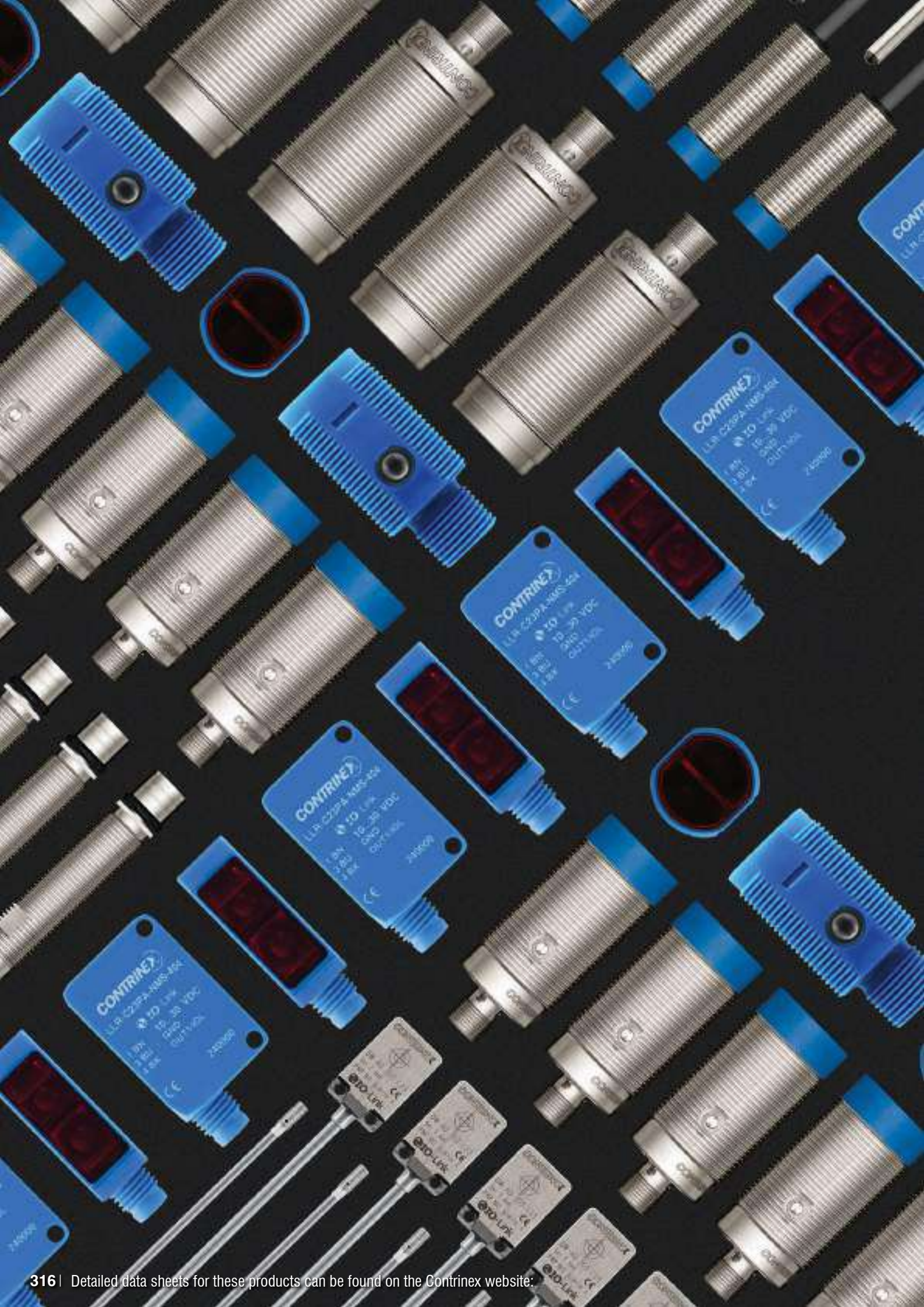



# GLOSSARY

- ✓ Autocollimation
- ✓ Background suppression
- ✓ Classics family
- ✓ Excess-gain indication (system reserve indication)
- ✓ Extra distance family
- ✓ Full Inox family
- ✓ Hysteresis
- ✓ IO-Link
- ✓ Mounting
- ✓ Operating distance
- ✓ Parallel connection
- ✓ Sensing range
- ✓ Series connection
- ✓ Smart Sensors
- ✓ Standards
- ✓ Switching frequency
- ✓ Tightening torque
- ✓ Wiring

# GLOSSARY

## INDUCTIVE SENSORS

## PHOTOELECTRIC SENSORS

# A

## AUTOCOLLIMATION

Photoelectric sensors using the autocollimation principle are characterized by the fact that the optical axes of the emitting and receiving channels are identical. This is possible with light from one of the channels being deflected by means of a semi-transparent mirror (Fig. 12). This principle completely eliminates the interfering blind zone often found in the proximity of the sensor, which is of special advantage when using reflex sensors.

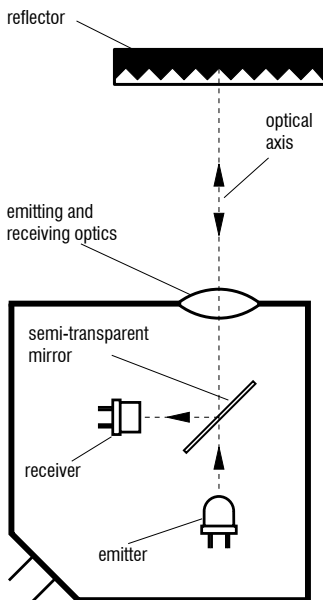

Fig. 12

# B

## BACKGROUND SUPPRESSION

The light pulse from the emitting diode leaves the optical system as a focused, almost parallel, light beam. On meeting an object in its path, part of the beam is diffusely reflected, and in turn, part of this reflected light falls on the PSD (Position-Sensitive Device) housed in the same sensor (Fig. 13).

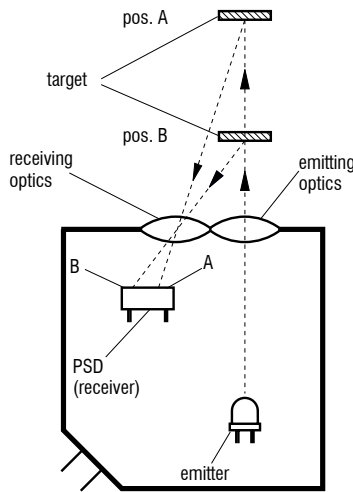

Fig. 13

Depending on the distance of the target from the device, the light falls on a particular spot of the PSD, and a corresponding reception signal is emitted, indicating that an object is present at a certain distance from the device. The analyzing circuit compares the signal received with the preset operating distance (adjusted by means of the built-in potentiometer), and, if the distance of the object is less than, or equal to, the preset operating distance, the output is switched. Contrary to an energetic diffuse sensor, the operating distance depends only to a very small extent on the target's size or color, or on the nature of its surface. The object can therefore be easily discerned, even against a light background.

# C

## CLASSICS FAMILY

The **Classics** family (series 600) is one of three inductive sensing technologies offered by Contrinex. **Classics** family sensors rely on conventional inductive oscillator and coil technology (see page 30).

Sensors are sized from Ø3 up to M30 and C44 (40 × 40 mm). PNP, NPN and 2-wire AC/DC output configurations are available, combined with sensing distances between 0.6 mm and 40 mm. The **Classics** technology family includes devices from the following ranges: **Basic, Miniature, 2-Wire, Extra Pressure, Extra Temperature, High Temperature and Washdown.**

# E

## EXCESS-GAIN INDICATION (SYSTEM RESERVE INDICATION)

The excess-gain indication circuit detects the excess radiation power which falls on the light incidence surface and is processed by the light receiver. The excess gain can decrease in time due to dirt, a change in the target's reflection factor, and aging of the emitter diode, so that reliable operation can no longer be guaranteed. Some devices are therefore equipped with a second LED (green), which lights up when less than approximately 80% of the available operating distance is used. Models with an excess-gain output make the excess-gain signal available to the user for further processing. Thus, operating conditions which are no longer reliable can be recognized in time.

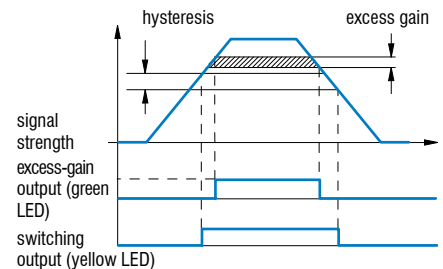

Fig. 14

## EXTRA DISTANCE FAMILY

The **Extra Distance** family (series 500/520) is one of three inductive sensing technologies offered by Contrinex. **Extra Distance** family sensors rely on conventional inductive oscillator and coil technology, but with a completely different signal evaluation circuit for better stability and therefore long operating distances. The most important contribution to this comes from the Contrinex Condist® oscillator (see page 30).

Sensors are sized from Ø4 to M30, with long operating distances up to 40 mm. The **Extra Distance** technology family includes devices from the **Basic, Miniature, Extra Pressure, High Pressure and Analog Output** ranges.

# F



## FULL INOX FAMILY

The **Full Inox** family (series 700) is one of three inductive sensing technologies offered by Contrinex. **Full Inox** family sensors rely on Contrinex's Condect® technology (see page 31).

**Full Inox** sensors have a one-piece, stainless steel housing and are exceptionally robust and chemically resistant. They are not only the most durable inductive sensors on the market, but also offer long operating distances on any conductive metal.

Sensors are sized from Ø4 to M30 and cuboid variant of 20 × 32 × 8 mm, with long operating distances up to 40 mm and protection class IP67 and IP69K.

The **Full Inox** technology family includes devices from the **Basic, Miniature, Extreme, High Pressure, Washdown, Weld-Immune, Chip-Immune, Double-Sheet** and **Maritime** ranges.

# H



## HYSTERESIS

Hysteresis (differential travel) causes a defined switching behavior of the device (Fig. 15). The sensing range always refers to the switch-on point. Distance hysteresis is only useful for the diffuse sensor model and its related fiber version.

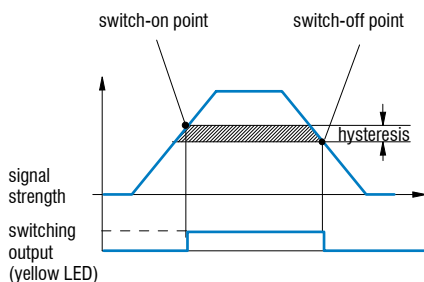

Fig. 15



Hysteresis (differential travel) causes a defined switching behavior of the device (Fig. 16). The operating distance always refers to the switch-on point. Namur devices and those with analog output have continuous transmission behavior, i.e. there is no hysteresis.

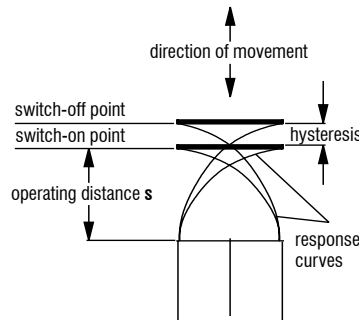

Fig. 16



## IO-LINK

IO-Link is an industry-standard (IEC 61131-9) point-to-point communication protocol for digital sensors and actuators. Using simple three- or four-wire cables, IO-Link enables these devices to communicate via an IO-Link master to any industrial-fieldbus network, or directly using a standard IO signal. IO-Link is highly flexible, allowing user-defined sensor configuration of many functions.

# M



## MOUNTING

### EMBEDDABLE SENSORS

Embeddable sensors may be flush mounted in all metals. For trouble-free operation, a free zone according to Fig. 17 should be observed.

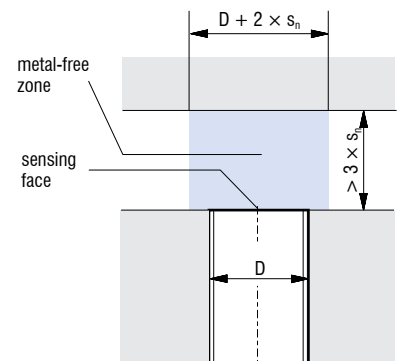

Fig. 17

### QUASI-EMBEDDABLE SENSORS

When installing quasi-embeddable Extra Distance sensors (500 and 520 series) in conductive materials (metals), the devices must **protrude** by a distance **X**, according to Fig. 18. Further, a free zone of  $3 \times s_n$  must be observed. Flush mounting in non-conducting materials is permitted.

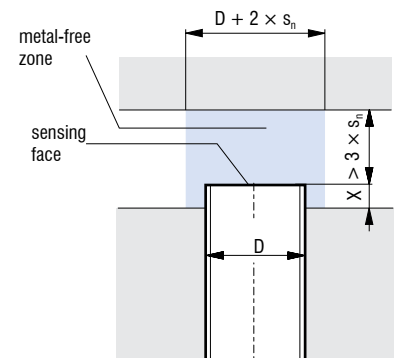

Fig. 18

### NON-EMBEDDABLE SENSORS

When mounting non-embeddable sensors in conducting materials (metals), minimum distances to the conducting material must be maintained according to Fig. 19. Flush mounting in non-conducting materials is permitted.

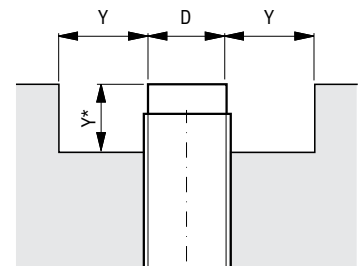

Fig. 19

## O

### OPERATING DISTANCE

The operating distance of inductive sensors is the distance at which a target approaching the sensing face triggers a signal change. The operating distance is measured according to IEC 60947-5-2/EN 60947-5-2, using a **standard square target** moving **axially** (Fig. 20).

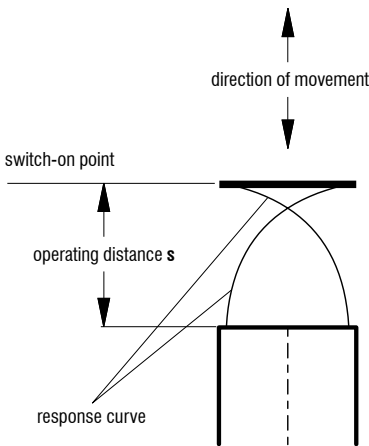

Fig. 20

This target is made of steel, e.g. type FE 360 in accordance with ISO 630, with a smooth surface, square shape, and thickness of 1 mm (Fig. 21). The sides equal the **diameter** of the inscribed circle of the sensing face or **three times the rated operating distance  $s_n$**  of the sensor, whichever is the greater.

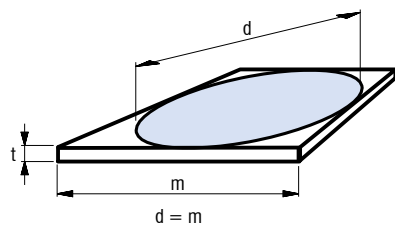

Fig. 21

#### Rated operating distance $s_n$

This is the operating distance for which the sensor is designed. It can be found under "technical data".

#### Effective operating distance $s_e$

The measured operating distance for a given switch according to IEC 60947-5-2/EN 60947-5-2.

$$0.9 s_n \leq s_e \leq 1.1 s_n$$

This means that the manufacturing tolerance must not exceed  $\pm 10\%$ .

#### Usable operating distance $s_u$

This distance takes into account expected additional deviations caused by temperature and supply voltage fluctuations within the specified range.

$$0.9 s_e \leq s_u \leq 1.1 s_e$$

The temperature and supply voltage ranges can be found under "technical data".

#### Assured operating distance $s_a$

$$0 \leq s_a \leq 0.81 s_n$$

This operating distance is guaranteed by the manufacturer for all specified operating conditions. It is the **basis for a safe design**.

## P

### PARALLEL CONNECTION

Connecting sensors in parallel, in order to perform logic functions, is possible without any problem (Figs. 22 and 23).

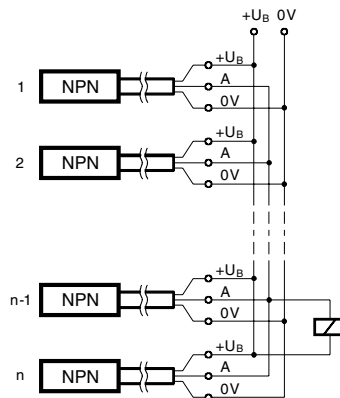

Fig. 22

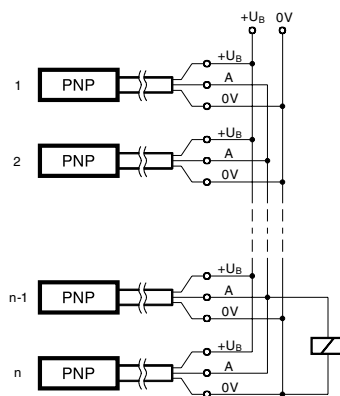

Fig. 23

Please note:

- The no-load supply current increases.
- Leakage currents add up, so that, even when closed, an inadmissible voltage drop can occur at the output.

## S

### SENSING RANGE

The specified sensing range of photoelectric sensors is the maximum usable distance between the device and the standard target (diffuse sensors); between the device and the reference reflector (reflex sensors), and between the emitter and the receiver (through-beam sensors). The potentiometer must be set for maximum sensitivity, or for diffuse sensors with background suppression, for maximum sensing range. Moreover, the specified reflector (reflex sensors) or standard target (diffuse sensors) must be used.

### SERIES CONNECTION

The connection of sensors in series in order to achieve logic functions is possible, but not recommended. The same effect can be achieved by the **parallel connection** of sensors with **NC function** (instead of the series connection of models with NO function), or vice versa. However, please note that, as a result, the output signal is inverted.

### SMART SENSORS

SMART Sensors are digital devices that offer the advantages of the industry-standard IO-Link SSP 3.3 profile plus the extreme flexibility of leading-edge multi-mode sensing capabilities, including distance, temperature and cycle counting. Depending on the user-defined mode of operation, measurements may be output as either routine process data or stand alone IO event data.

## STANDARDS

The sensors in this catalog comply, either completely or to a great extent, with the following standards:

- IEC 60947-5-1, **IEC 60947-5-2**, EN 60947-5-1, **EN 60947-5-2**
- IEC 61000-4-1, 61000-4-2, 61000-4-3, 61000-4-4, DIN EN 55011, DIN EN 55081-2, DIN EN 50140
- IEC 60529 / DIN 40050
- IEC 60947-1 / EN 60947-1 / DIN VDE 0660, part 100, part 100 A3, part 200, part 208
- DIN EN 50008, 50010, 50025, 50026, 50032, 50036, 50037, 50038, 50040, 50044

## SWITCHING FREQUENCY

The maximum switching frequency of inductive sensors indicates the highest permissible number of pulses per second for a constant pulse/pause ratio of 1:2 at **half the rated operating distance**  $s_n$ . Measurement is according to IEC 60947-5-2 / EN 60947-5-2 (Fig. 24).

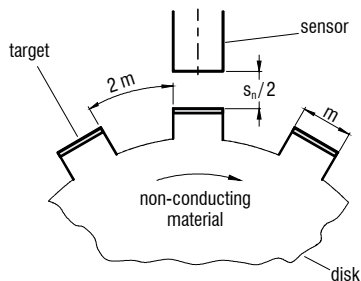

Fig. 24

## STANDARDS

In the case of photoelectric sensors, the frequency of operating cycles (f) is determined from the formula:

$$f = \frac{1}{t_{on} + t_{off}}$$

where:  $t_{on}$  is the turn on time  
 $t_{off}$  is the turn off time

$t_{on}$  and  $t_{off}$  are measured in accordance with IEC 60947-5-2 2007 paragraph 8.5.3.

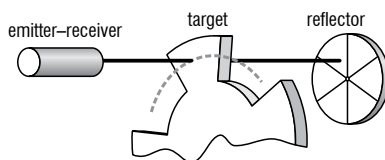
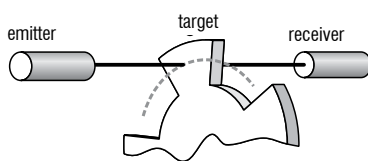

Fig. 25: Through-beam and reflex modes: the light beam must be fully broken by the target.

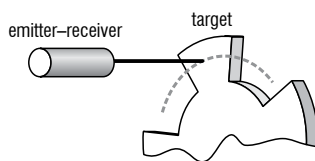

Fig. 26: Diffuse mode: the target must be of the same material as the standard target.

## TIGHTENING TORQUE

## TIGHTENING TORQUE

Over-tightening of the nuts can mechanically damage cylindrical sensors. The specified maximum permissible tightening torques must therefore not be exceeded.

## CLASSICS / EXTRA DISTANCE

### (SERIES 500\*, 520\*, 600, 620)

Housing size D	M (Nm)
M4	0.8
M5	1.5
C5	0.2
M8	8 / 4*
C8	1
M12	10**
M18	25
M30	70
C44	2.5

\*\*6 Nm for the first 10 mm

## FULL INOX (SERIES 700)

### FULL INOX (SERIES 700)

Housing size D	M (Nm)
M8	8
M12	20
M18	50
M30	150

## SERIES D04 / M5, 1120, 1180, 1180W

### SERIES D04 / M5, 1120, 1180, 1180W

Housing size D	M (Nm)
M5	1.5
M12	10
M18 / M18W	20

## WIRING

## WIRING

Sensor cables must not be laid in parallel in the same cable runs as cables connected to **inductive loads** (i.e. protection solenoids, magnetic rectifiers, motors, etc.), or which conduct currents from **electronic motor drives**. Leads should be kept as short as possible; however, with suitable wiring (low coupling capacitance, small interference voltages), they can be up to 300 m long.

To reduce electromagnetic interference, apply the following measures:

- Maintain the distance to interfering cables > 100 mm
- Use shields
- Install inductances (contactors, magnetic rectifiers, relays) with RC networks or varistors



ALL OVER THE WORLD

**EUROPE**

Austria  
Belgium  
Croatia  
Czech Republic  
Denmark  
Estonia  
Finland  
**France\***  
**Germany\***  
Great Britain  
Greece  
Hungary  
Ireland  
**Italy\***  
Luxembourg  
Netherlands  
Norway  
Poland  
**Portugal\***  
Romania  
Russian Federation

Serbia  
Slovakia  
Slovenia  
Spain  
Sweden  
**Switzerland\***  
Turkey  
Ukraine

**AFRICA**

Morocco  
South Africa

**THE AMERICAS**

Argentina  
**Brazil\***  
Canada  
Chile  
**Mexico\***  
Peru  
**United States\***

**ASIA**

**China\***  
**India\***  
Indonesia  
**Japan\***  
Korea  
Malaysia  
Pakistan  
Philippines  
Singapore  
Taiwan  
Thailand

**AUSTRALASIA**

Australia  
New Zealand

**MIDDLE EAST**

Israel  
United Arab Emirates

Terms of delivery and right to change design reserved.

\*Contrinex subsidiary

**HEADQUARTERS**

**CONTRINEX AG** Industrial Electronics  
Route du Pâqui 3 – PO Box – CH-1720 Corminboeuf – Switzerland  
Tel: +41 26 460 46 46 – Fax: +41 26 460 46 40  
Internet: [www.contrinex.com](http://www.contrinex.com) – E-mail: [info@contrinex.com](mailto:info@contrinex.com)



[www.contrinex.com](http://www.contrinex.com)

