

Näherungsschalter

induktiv, kapazitiv

Proximity Switches

inductive, capacitive



Anwesenheit sicher kontrolliert
Reliably monitoring presence

Allgemeine Beschreibung

di-soric Näherungsschalter sind in einer Vielzahl von verschiedenen Bauformen und für unterschiedlichste Anwendungen erhältlich. Von der Standardanwendung bis zu höchsten technischen Anforderungen erfüllen di-soric Näherungsschalter alle Aufgaben perfekt. Ein komplettes Produktprogramm, immer auf dem Stand der neuesten Technik und überzeugend durch seine beeindruckende Qualität und Zuverlässigkeit.

Das Produktprogramm

- Induktive und kapazitive Näherungsschalter
- Miniaturbauformen
- Zylindrische und quaderförmige Bauformen
- Näherungsschalter mit großen Schaltabständen
- Näherungsschalter mit geschlossener Ganzstahlhülse
- Druckfeste Näherungsschalter
- Hoch- und tiefemperaturfeste Näherungsschalter
- Näherungsschalter mit Analogausgang
- Kundenspezifische Ausführungen

General description

di-soric proximity switches are available in a multiplicity of different designs and for most different applications. From the standard application to highest technical requirements, di-soric proximity switches perform all tasks perfectly. A complete product program, always on the state of the latest technology and convincing by its impressive quality and reliability.

The product program

- Inductive and capacitive proximity switches
- Miniature designs
- Cylindrical and rectangular designs
- Proximity switches with large operating distances
- Proximity switches with all stainless steel housing
- Pressure resistant proximity switches
- High- and low-temperature resistant proximity switches
- Proximity switches with analog output
- Customized designs

Applikationen | Applications

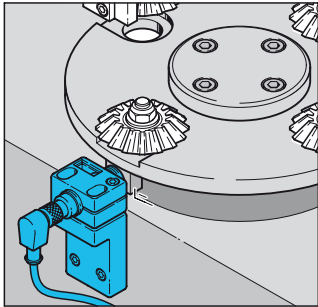

Positionieraufgaben an Montageautomaten
Positioning tasks on automatic assembly machines

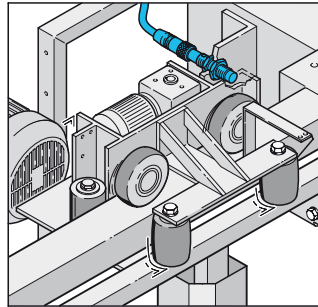

Positionsabfrage an Traversen
Position check on crossbars

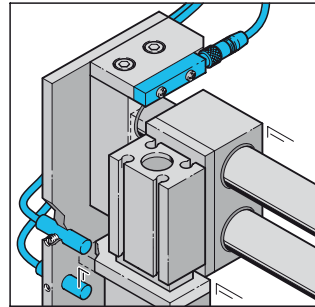

Positionsabfrage an Linearführungen
Position detection on linear guides

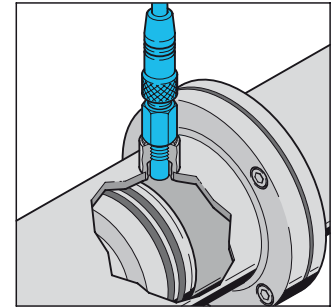

Druckfeste Näherungsschalter z. B. zur Positionserkennung in Hydraulikzylindern
Pressure resistant proximity switches e. g. for position detection in hydraulic cylinders

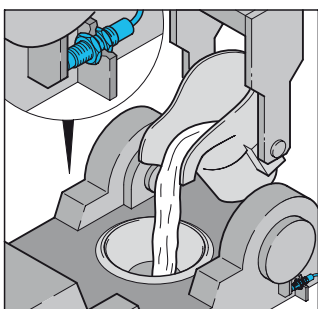

Hochtemperaturfeste Näherungsschalter z. B. zum Einsatz in Gießereien oder der Hüttenindustrie
High-temperature resistant proximity switches e. g. for the use in foundries or in the steel and iron industry

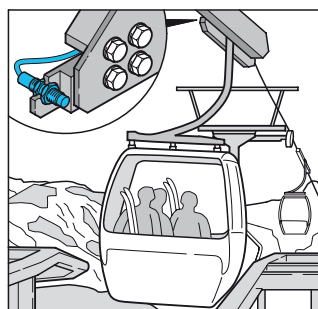

Tiefemperaturfeste Näherungsschalter z. B. zum Einsatz im Außenbereich
Low-temperature resistant proximity switches e. g. for outdoor use

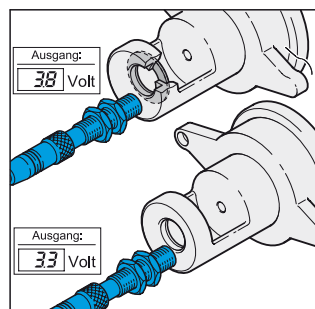

Analoger ind. Näherungsschalter zum Detektieren von Stahlscheiben in Druckgusskörpern
Analoge ind. proximity switches for detection of steel discs in die-cast casings

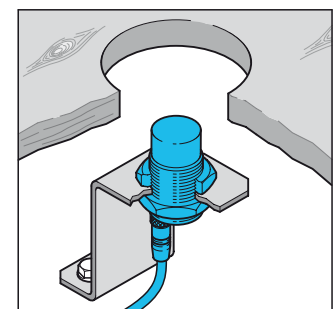

Kapazitive Näherungsschalter z. B. zum Einsatz in der Holzverarbeitenden Industrie
Capacitive proximity switches e. g. for use in the wood-processing industry

Sicherheitshinweis

Die Geräte sind nicht zulässig für Sicherheitsanwendungen, insbesondere bei denen die Sicherheit von Personen von der Gerätefunktion abhängig ist.

Alle technischen Angaben beziehen sich auf den Stand 11/12, Änderungen bleiben vorbehalten. Da Irrtümer und Druckfehler nicht auszuschließen sind, gilt für alle Angaben „ohne Gewähr“.

Safety instruction

The instruments are not to be used for safety applications, in particular applications in which safety of persons depends on proper operation of the instruments.

All technical specifications refer to the state of the art 11/12, they are subject to modifications. As typographical and other errors cannot be excluded, all data are given „without engagement“.

Induktive Näherungsschalter / Inductive proximity switches

Bauform (mm) Size (mm)	Schaltabstand Operating distance	Seite Page
Standardausführung / Standard version	0,6 ... 65 mm	10 ... 39
Ganzstahlhülse geschlossen / all stainless steel housing Ø6,5 mm / M8 ... M30	2,0 ... 40 mm	40 ... 45
Lebensmittelecht und meerwasserfest / Food-save and seawater resistant M12 ... M30	6,0 ... 40 mm	46 ... 49
Druckfest / Pressure resistant Ø4 ... 6,5 mm / M5 ... M18	0,6 ... 3,0 mm	50 ... 53
Hochtemperaturfest bis 230°C / High-temperature resistant up to 230°C M12 ... M50	2,0 ... 7,0 mm	54 ... 61
Tiefteperaturfest bis -55°C / Low-temperature resistant up to -55°C M12 ... M18	2,0 ... 7,0 mm	62 ... 63
Analogausgang / Analog output M8 ... M30	4,0 ... 20 mm	64 ... 68
□ 8x8 mm	4,0 mm	67
Nach NAMUR / Acc. to NAMUR Ø6,5 mm	1,5 mm	68 ... 69
M8	1,5 mm	68 ... 69
Allspannung / AC/DC M12 ... M30	2,0 ... 15 mm	70 ... 73
□ 120x40x40 mm	20 mm	73

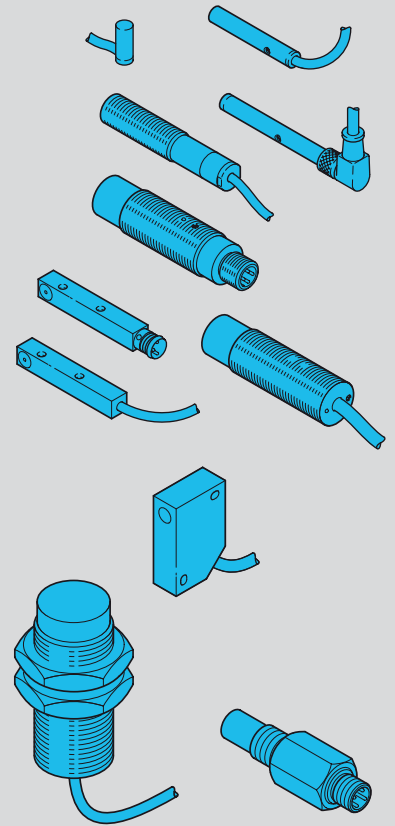

Kapazitive Näherungsschalter / Capacitive proximity switches

Bauform (mm) Size (mm)	Schaltabstand Operating distance	Seite Page
Ø6,5 ... 50 mm	1,5 ... 25 mm	74 ... 79
M8 ... M30	1,5 ... 30 mm	75 ... 78
□ 34x16x8 mm	8 mm	80 ... 81

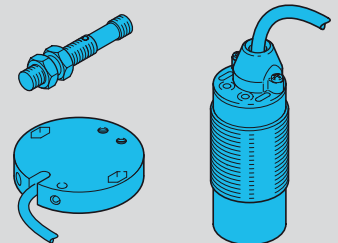

Zubehör / Accessories

Sensorhalter / Mounting bracket	82 ... 83
---------------------------------	-----------

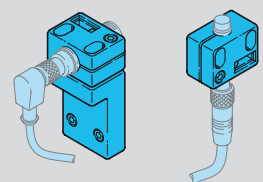

Begriffserklärungen und Einbauhinweise / Explanations and installation notes

	Seite Page
Induktive Näherungsschalter / Inductive proximity switches	
Begriffserklärungen / Explanations	84
Einbauhinweise / Installation notes	85 ... 101
Kapazitive Näherungsschalter / Capacitive proximity switches	
Begriffserklärungen / Explanations	102
Einbauhinweise / Installation notes	103

Inhaltsverzeichnis nach Funktionsprinzip | Table of content as per working principle

Induktive Näherungsschalter in zylindrischer Bauform								
Cylindrical inductive proximity switches								
Bauform Design	Schaltabstand Operating distance	Montage Mounting			Anschluss Connection		Seite Page	
		b ¹⁾	qb ²⁾	nb ³⁾	Kabel / cable	M8 M12		
Ø3 mm / M4x0,5	0,6 mm I	■			■	■	10	
	1,0 mm I	■			■	■	10, 11	
Ø4 mm / M5x0,5	0,8 mm I	■			■	■	11, 12	
	1,5 mm ■	■			■	■	11, 12	
	2,5 mm ■	■			■	■	12, 13	
Ø6,5 mm	1,5 mm ■	■			■	■	■	13, 14
	2,0 mm ■	■			■	■	■	15, 16
	3,0 mm ■		■		■	■	■	16, 17
Ø8 mm	1,5 mm ■	■					■	17
	2,0 mm ■	■				■		17
M8x1	1,5 mm ■	■			■	■	■	17 - 19
	2,0 mm ■	■			■	■	■	19, 20
	2,5 mm ■			■	■	■	■	20, 21
	3,0 mm ■	■			■	■	■	22
	4,0 mm ■		■	■	■	■	■	22, 23
	6,0 mm ■			■	■	■	■	23
M12x1	2,0 mm ■	■			■		■	23, 24
	4,0 mm ■	■		■	■		■	24, 25
	6,0 mm ■		■		■		■	25, 26
	8,0 mm ■		■		■		■	26
	10 mm ■			■	■		■	26, 27
M18x1	5,0 mm ■	■			■		■	27, 28
	8,0 mm ■			■	■		■	28, 29
	12 mm ■			■	■		■	29, 30
	20 mm ■			■	■		■	30
M30x1,5	10 mm ■	■			■		■	30, 31
	15 mm ■			■	■		■	31, 32
	22 mm ■		■		■		■	32
	40 mm ■			■	■		■	32, 33

1) Bündiger Einbau in Metall
 2) Quasi bündiger Einbau in Metall
 3) Nicht bündiger Einbau in Metall
 Siehe auch Seite 9 Ausklappteil, Begriffserklärungen und Einbauhinweise ab Seite 84.

1) Flush-fitted in metal
 2) Quasi flush-fitted in metal
 3) Non flush-fitted in metal
 See also fold-out page 9, explanations and installation notes from page 84.

Induktive Näherungsschalter in quaderförmiger Bauform							
Inductive proximity switches, cuboid design							
Bauform Design	Schaltabstand Operating distance	Montage Mounting			Anschluss Connection		Seite Page
		b ¹⁾	qb ²⁾	nb ³⁾	Kabel /cable	M8 M12	
□ 5x5 mm	0,8 mm ■	■			■	■	34
	1,5 mm ■	■			■	■	34
□ 8x8 mm	1,5 mm ■	■			■	■	34, 35
	2,0 mm ■	■			■	■	35
	3,0 mm ■		■		■	■	36
□ 12x12 mm	2,0 mm ■	■			■	■	36
28x16x10 mm	2,0 mm ■	■			■	■	36
30x20x11,5 mm	1,5 mm ■	■				■	37
40x26x12 mm	2,0 mm ■	■			■	■	37
	4,0 mm ■			■	■	■	37
67x40x40 mm	20 mm ■	■					■
	40 mm ■			■			■
□ 118x40x40 mm	20 mm ■	■			■		38
	40 mm ■			■	■		39

1) Bündiger Einbau in Metall

2) Quasi Bündiger Einbau in Metall

3) Nicht Bündiger Einbau in Metall

Siehe auch Seite 9 Ausklappenteil, Begriffserklärungen und Einbauhinweise ab Seite 84.

















1) Flush-fitted in metal







2) Quasi flush-fitted in metal





3) Non flush-fitted in metal

See also fold-out page 9, explanations and installation notes from page 84.

Inhaltsverzeichnis nach Funktionsprinzip | Table of content as per working principle

Induktive Näherungsschalter mit geschlossener Ganzstahlhülse								
Inductive proximity switches with all stainless steel housing								
Bauform Design	Schaltabstand Operating distance	Montage Mounting			Anschluss Connection			Seite Page
		b ¹⁾	qb ²⁾	nb ³⁾	Kabel /cable	M8	M12	
Ø6,5 mm	2,0 mm 	■				■		40
M8 x 1	2,0 mm 	■				■		40
	3,0 mm 	■			■	■	■	41
	6,0 mm 			■	■	■	■	41
M12 x 1	2,0 mm 	■			■		■	42
	4,0 mm 			■	■		■	42
	6,0 mm 	■			■		■	42
	10 mm 			■	■		■	43
M18 x 1	5,0 mm 	■			■		■	43
	8,0 mm 			■	■		■	43
	10 mm 	■			■		■	44
	20 mm 			■	■		■	44
M30 x 1,5	10 mm 	■			■		■	44
	15 mm 			■	■		■	45
	20 mm 	■			■		■	45
	40 mm 			■	■		■	45

Induktive Näherungsschalter in lebensmittelechter und meerwasserfester Ausführung								
Inductive proximity switches, food-safe and seawater resistant								
Bauform Design	Schaltabstand Operating distance	Montage Mounting			Anschluss Connection			Seite Page
		b ¹⁾	qb ²⁾	nb ³⁾	Kabel /cable	M8	M12	
M12 x 1	6,0 mm 	■			■		■	46
	10 mm 			■	■		■	46
M18 x 1	10 mm 	■			■		■	47
	20 mm 			■	■		■	47
M30 x 1,5	20 mm 	■			■		■	48
	40 mm 			■	■		■	48

Induktive Näherungsschalter, druckfest									
Inductive proximity switches, pressure resistant									
Bauform Design	Schaltabstand Operating distance	Druck Pressure	Montage Mounting			Anschluss Connection			Seite Page
			b ¹⁾	qb ²⁾	nb ³⁾	Kabel /cable	M8	M12	
Ø4 mm / M5 x 0,5	0,6 mm 	20 bar	■			■		50	
Ø6,5 mm / M8 x 1	2,5 mm 	20 bar	■			■		50	
M12 x 1	2,0 mm 	500 bar	■				■	51, 52	
M18 x 1	1,5 mm 	500 bar	■				■	52	

1) Bündiger Einbau in Metall
 2) Quasi bündiger Einbau in Metall
 3) Nicht bündiger Einbau in Metall
 Siehe auch Seite 9 Ausklappteil, Begriffserklärungen und Einbauhinweise ab Seite 84.

1) Flush-fitted in metal
 2) Quasi flush-fitted in metal
 3) Non flush-fitted in metal
 See also fold-out page 9, explanations and installation notes from page 84.

Induktive Näherungsschalter, hochtemperaturfest									
Inductive proximity switches, high-temperature resistant									
Bauform Design	Schaltabstand Operating distance	Temperatur Temperature	Montage Mounting			Anschluss Connection			Seite Page
			b ¹⁾	qb ²⁾	nb ³⁾	Kabel / cable	M8	M12	
M12x1	2,0mm ■	120°C	■			■			54
	4,0mm ■■	120°C			■	■			54
M18x1	5,0mm ■■	120°C	■			■			54
	7,0mm ■■■	120°C			■	■			54
	5,0mm ■■	160°C	■			■			55
	10mm ■■■■	160°C	■			■			55
M8x1	2,0mm ■	140°C	■			■			56
M12x1	3,0mm ■■	140°C	■			■			56
M18x1	5,0mm ■■	180°C / 230°C	■			■			57
	8,0mm ■■■	180°C			■	■			57
M30x1,5	10mm ■■■■	180°C / 230°C	■			■			58
	15mm ■■■■■	180°C / 230°C			■	■			58, 59
M50x1,5	20mm ■■■■■■	180°C / 230°C			■	■			59
	25mm ■■■■■■■	180°C / 230°C			■	■			60

Induktive Näherungsschalter, tieftemperaturfest									
Inductive proximity switches, low-temperature resistant									
Bauform Design	Schaltabstand Operating distance	Temperatur Temperature	Montage Mounting			Anschluss Connection			Seite Page
			b ¹⁾	qb ²⁾	nb ³⁾	Kabel / cable	M8	M12	
M12x1	2,0mm ■	-55°C	■			■			62
	4,0mm ■■	-55°C			■	■			62
M18x1	5,0mm ■■	-55°C	■			■			62
	7,0mm ■■■	-55°C			■	■			62

Induktive Näherungsschalter mit Analogausgang									
Inductive proximity switches with analog output									
Bauform Design	Schaltabstand Operating distance	Analogausgang Analog output	Montage Mounting			Anschluss Connection			Seite Page
			b ¹⁾	qb ²⁾	nb ³⁾	Kabel / cable	M8	M12	
M8x1	0...4mm ■	0...10 V			■	■		■	64
M12x1	0...6mm ■■	0...10 V			■	■		■	64, 65
	0...6mm ■■	0...10 V / 4...20mA			■	■		■	65
M18x1	0...10mm ■■■	0...10 V / 4...20mA			■	■		■	65, 66
M30x1,5	0...20mm ■■■■	0...10 V / 4...20mA			■	■		■	66
□ 8x8mm	0...4mm ■	0...10 V			■	■	■		67

1) Bündiger Einbau in Metall

2) Quasi bündiger Einbau in Metall

3) Nicht bündiger Einbau in Metall

Siehe auch Seite 9 Ausklappenteil, Begriffserklärungen und Einbauhinweise ab Seite 84.

1) Flush-fitted in metal

2) Quasi flush-fitted in metal

3) Non flush-fitted in metal

See also fold-out page 9, explanations and installation notes from page 84.













Inhaltsverzeichnis nach Funktionsprinzip | Table of content as per working principle

Induktive Näherungsschalter nach NAMUR Inductive proximity switches acc. to NAMUR							
Bauform Design	Schaltabstand Operating distance	Montage Mounting			Anschluss Connection		Seite Page
		b ¹⁾	qb ²⁾	nb ³⁾	Kabel /cable	M8 M12	
Ø 6,5 mm	1,5 mm ■	■			■		68
M8x1	1,5 mm ■	■			■	■	68

Induktive Näherungsschalter für Allspannung Inductive proximity switches AC/DC							
Bauform Design	Schaltabstand Operating distance	Montage Mounting			Anschluss Connection		Seite Page
		b ¹⁾	qb ²⁾	nb ³⁾	Kabel /cable	M8 M12	
M12x1	2,0 mm ■	■			■	■	70
M12x1	4,0 mm ■■			■	■	■	71
M18x1	5,0 mm ■■	■			■	■	71
M18x1	8,0 mm ■■■			■	■	■	72
M30x1,5	10 mm ■■■■	■			■	■	72
M30x1,5	15 mm ■■■■■			■	■	■	72
□ 120x40x40 mm	20 mm ■■■■■■	■			■		73

1) Bündiger Einbau in Metall
 2) Quasi bündiger Einbau in Metall
 3) Nicht bündiger Einbau in Metall
 Siehe auch Seite 9 Ausklappteil, Begriffserklärungen und Einbauhinweise ab Seite 84.

1) Flush-fitted in metal
 2) Quasi flush-fitted in metal
 3) Non flush-fitted in metal
 See also fold-out page 9, explanations and installation notes from page 84.

Kapazitive Näherungsschalter								
Capacitive proximity switches								
Bauform Design	Schaltabstand Operating distance	Montage Mounting			Anschluss Connection			Seite Page
		b ¹⁾	qb ²⁾	nb ³⁾	Kabel / cable	M8	M12	
Ø 6,5 mm	1,5 mm 	■			■	■		72
	3,0 mm 			■	■	■		72
M8 x 1	1,5 mm 	■			■	■		73
	3,0 mm 			■	■	■		73
M12 x 1	4,0 mm 	■			■		■	73
	8,0 mm 			■	■		■	74
M18 x 1	8,0 mm 	■			■		■	74
	15 mm 			■	■		■	74
	20 mm 	■			■		■	75
M30 x 1,5	30 mm 			■	■		■	75, 76
	Ø 50 mm 25 mm 	■			■	■		76, 77
□ 34 x 16 x 8 mm	8,0 mm 	■			■	■		78, 79

1) Bündiger Einbau in Metall
 2) Quasi Bündiger Einbau in Metall
 3) Nicht Bündiger Einbau in Metall
 Siehe auch Seite 9 Ausklappteil, Begriffserklärungen und Einbauhinweise ab Seite 84.

1) Flush-fitted in metal
 2) Quasi flush-fitted in metal
 3) Non flush-fitted in metal
 See also fold-out page 9, explanations and installation notes from page 84.

Induktive Näherungsschalter | Inductive proximity switches

b 0,6 mm



b 0,6 mm



b 1 mm

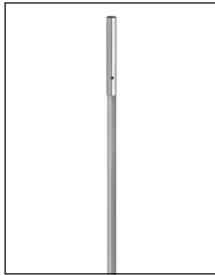

b 1 mm



b 0,6 mm



b 0,6 mm



Ø 3 mm
Einbauhinweise
siehe Seite 85 ①
Installation notes
see page 85 ①

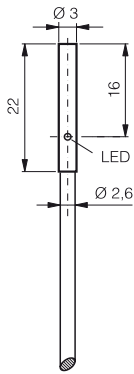

mm (typ.)

Ø 3 mm
Einbauhinweise
siehe Seite 85 ①
Installation notes
see page 85 ①

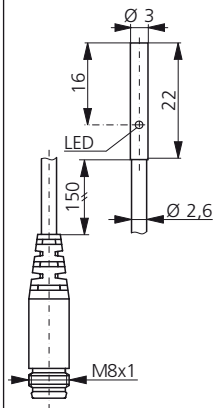

mm (typ.)

Ø 3 mm
Einbauhinweise
siehe Seite 89 ③
Installation notes
see page 89 ③

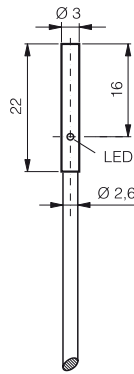

mm (typ.)

Ø 3 mm
Einbauhinweise
siehe Seite 89 ③
Installation notes
see page 89 ③

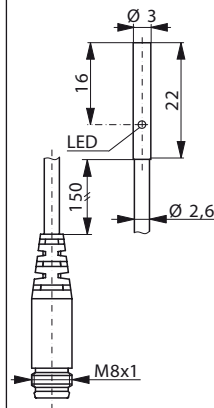

mm (typ.)

M4x0,5
Einbauhinweise
siehe Seite 85 ①
Installation notes
see page 85 ①

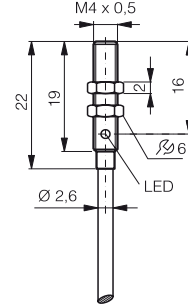

mm (typ.)

M4x0,5
Einbauhinweise
siehe Seite 85 ①
Installation notes
see page 85 ①

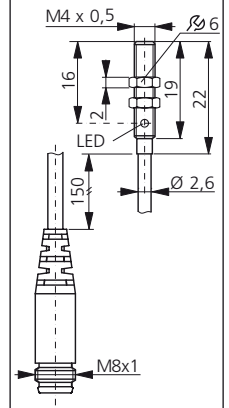

mm (typ.)

0,6 mm	0,6 mm	1 mm	1 mm	0,6 mm	0,6 mm
3x3x1 mm	3x3x1 mm	3x3x1 mm	3x3x1 mm	4x4x1 mm	4x4x1 mm
10 ... 30VDC	10 ... 30VDC	10 ... 30VDC	10 ... 30VDC	10 ... 30VDC	10 ... 30VDC
100 mA	100 mA	100 mA	100 mA	100 mA	100 mA
< 10 mA	< 10 mA	< 10 mA	< 10 mA	< 10 mA	< 10 mA
< 2,0 V	< 2,0 V	< 2,0 V	< 2,0 V	< 2,0 V	< 2,0 V
5.000 Hz	5.000 Hz	3.000 Hz	3.000 Hz	5.000 Hz	5.000 Hz
5 %	5 %	5 %	5 %	5 %	5 %
-25 ... +70 °C	-25 ... +70 °C	-25 ... +70 °C	-25 ... +70 °C	-25 ... +70 °C	-25 ... +70 °C
500 V	500 V	500 V	500 V	500 V	500 V
IP 67	IP 67	IP 67	IP 67	IP 67	IP 67
VA	VA	VA	VA	VA	VA
2.0 m, PUR	0,15 m, PUR	2.0 m, PUR	0,15 m, PUR	2.0 m, PUR	0,15 m, PUR

DCC 3.0 V 0.6 PSLK	DCC 3.0 V 0.6 PSK-K-TSL	DCC 3.0 V 1.0 PSLK	DCC 3.0 V 1.0 PSK-K-TSL	DCC 04 M 0.6 PSLK	DCC 04 M 0.6 PSK-K-TSL
DCC 3.0 V 0.6 POLK	DCC 3.0 V 0.6 POK-K-TSL	DCC 3.0 V 1.0 POLK	DCC 3.0 V 1.0 POK-K-TSL	DCC 04 M 0.6 POLK	DCC 04 M 0.6 POK-K-TSL
-	-	-	-	-	-
-	-	-	-	-	-
-	-	-	-	-	-
-	-	-	-	-	-
-	-	-	-	-	-
-	-	-	-	-	-
-	TK...	-	TK...	-	TK...
-	-	-	-	-	-

b 1 mm

b 1 mm

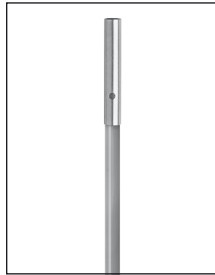
b 0,8 mm

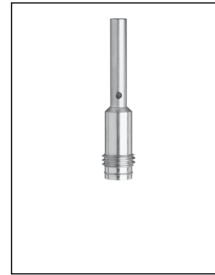
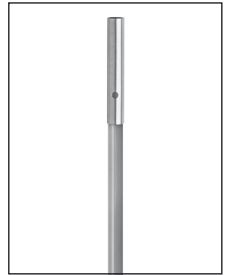
b 0,8 mm

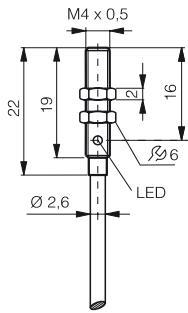
b 0,8 mm

b 1,5 mm

M4x0,5

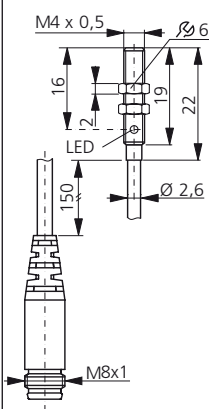
 Einbauhinweise
siehe Seite 89 ③
Installation notes
see page 89 ③

mm (typ.)

M4x0,5

 Einbauhinweise
siehe Seite 89 ③
Installation notes
see page 89 ③

mm (typ.)

Ø 4 mm

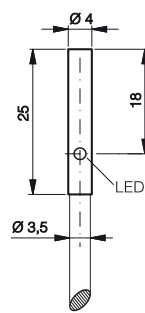
 Einbauhinweise
siehe Seite 85 ①
Installation notes
see page 85 ①

mm (typ.)

Ø 4 mm

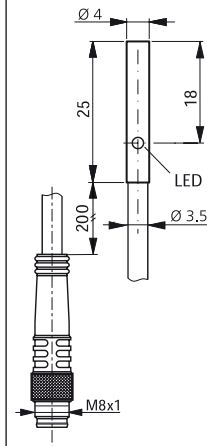
 Einbauhinweise
siehe Seite 85 ①
Installation notes
see page 85 ①

mm (typ.)

Ø 4 mm

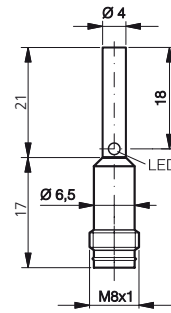
 Einbauhinweise
siehe Seite 85 ①
Installation notes
see page 85 ①

mm (typ.)

Ø 4 mm

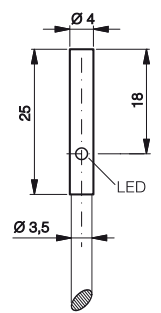
 Einbauhinweise
siehe Seite 89 ③
Installation notes
see page 89 ③

mm (typ.)

1 mm	1 mm	0,8mm	0,8mm	0,8mm	1,5 mm
4x4x1 mm	4x4x1 mm	4x4x1 mm	4x4x1 mm	4x4x1 mm	4,5x4,5x1 mm
10 ... 30VDC	10 ... 30VDC	10 ... 30VDC	10 ... 30VDC	10 ... 30VDC	10 ... 30VDC
100 mA	100 mA	200 mA	200 mA	200 mA	200 mA
< 10 mA	< 10 mA	< 10 mA	< 10 mA	< 10 mA	< 10 mA
< 2,0 V	< 2,0 V	< 2,0 V	< 2,0 V	< 2,0 V	< 2,0 V
3.000 Hz	3.000 Hz	5.000 Hz	5.000 Hz	5.000 Hz	3.000 Hz
5 %	5 %	5 %	5 %	5 %	5 %
-25 ... +70 °C	-25 ... +70 °C	-25 ... +70 °C	-25 ... +70 °C	-25 ... +70 °C	-25 ... +70 °C
500 V	500 V	500 V	500 V	500 V	500 V
IP 67	IP 67	IP 67	IP 67	IP 67	IP 67
VA	VA	VA	VA	VA	VA
2,0 m, PUR	0,15 m, PUR	2,0 m, PVC	0,2 m, PVC	-	2,0 m, PVC

DCC 04 V 1.0 PSLK	DCC 04 V 1.0 PSK-K-TSL	DCC 4.0 V 0.8 PSLK	DCC 4.0 V 0.8 PSK-KR-TSL	DCC 4.0 V 0.8 PSK-TSL	DCC 4.0 V 1.5 PSLK
DCC 04 V 1.0 POLK	DCC 04 V 1.0 POK-K-TSL	DCC 4.0 V 0.8 POLK	DCC 4.0 V 0.8 POK-KR-TSL	DCC 4.0 V 0.8 POK-TSL	DCC 4.0 V 1.5 POLK
-	-	-	-	-	-
-	-	-	-	-	-
-	-	-	-	-	-
-	-	-	-	-	-
-	-	-	-	-	-
-	-	-	-	-	-
-	TK ...	-	TK ...	TK ...	-
-	-	-	-	-	-

Induktive Näherungsschalter | Inductive proximity switches

b 1,5 mm

b 2,5 mm

b 2,5 mm

b 0,8 mm

b 0,8 mm

b 1,5 mm

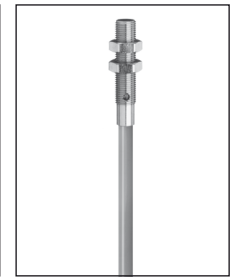
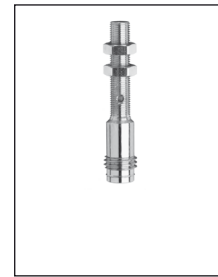
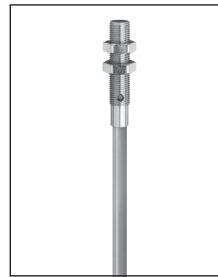
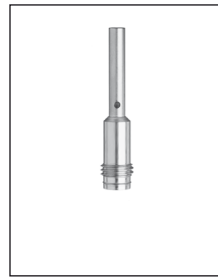
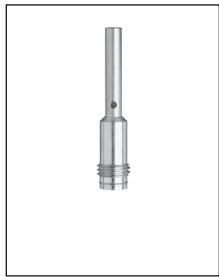

Ø 4 mm
Einbauhinweise siehe Seite 89 ③
Installation notes see page 89 ③

mm (typ.)

Ø 4 mm
Einbauhinweise siehe Seite 87 ②
Installation notes see page 87 ②

mm (typ.)

Ø 4 mm
Einbauhinweise siehe Seite 87 ②
Installation notes see page 87 ②

mm (typ.)

M5x0,5
Einbauhinweise siehe Seite 85 ①
Installation notes see page 85 ①

mm (typ.)

M5x0,5
Einbauhinweise siehe Seite 85 ①
Installation notes see page 85 ①

mm (typ.)

M5x0,5
Einbauhinweise siehe Seite 89 ③
Installation notes see page 89 ③

mm (typ.)

1,5 mm	2,5 mm	2,5 mm	0,8 mm	0,8 mm	1,5 mm
4,5x4,5x1 mm	7,5x7,5x1 mm	7,5x7,5x1 mm	5x5x1 mm	5x5x1 mm	5x5x1 mm
10 ... 30VDC	10 ... 30VDC	10 ... 30VDC	10 ... 30VDC	10 ... 30VDC	10 ... 30VDC
200 mA	200 mA	200 mA	200 mA	200 mA	200 mA
< 10 mA	< 10 mA	< 10 mA	< 10 mA	< 10 mA	< 10 mA
< 2,0 V	< 2,0 V	< 2,0 V	< 2,0 V	< 2,0 V	< 2,0 V
3.000 Hz	800 Hz	800 Hz	5.000 Hz	5.000 Hz	3.000 Hz
5 %	10 %	10 %	5 %	5 %	5 %
-25 ... +70 °C	-25 ... +70 °C	-25 ... +70 °C	-25 ... +70 °C	-25 ... +70 °C	-25 ... +70 °C
500 V	500 V	500 V	500 V	500 V	500 V
IP 67	IP 67	IP 67	IP 67	IP 67	IP 67
VA	VA	VA	VA	VA	VA
-	2,0 m, PVC	-	2,0 m, PVC	-	2,0 m, PVC

DCC 4.0 V 1.5 PSK-TSL	DCC 4.0 V 2.5 PSLK	DCC 4.0 V 2.5 PSK-TSL	DCC 05 M 0.8 PSLK	DCC 05 M 0.8 PSK-TSL	DCC 05 V 1.5 PSLK
DCC 4.0 V 1.5 POK-TSL	DCC 4.0 V 2.5 POLK	DCC 4.0 V 2.5 POK-TSL	DCC 05 M 0.8 POLK	DCC 05 M 0.8 POK-TSL	DCC 05 V 1.5 POLK
-	-	-	-	-	-
-	-	-	-	-	-
-	-	-	-	-	-
-	-	-	-	-	-
-	-	-	-	-	-
-	-	-	-	-	-
TK...	-	TK...	-	TK...	-
-	-	-	-	-	-

b 1,5 mm

b 2,5 mm

b 2,5 mm

b 1,5 mm

b 1,5 mm

b 1,5 mm

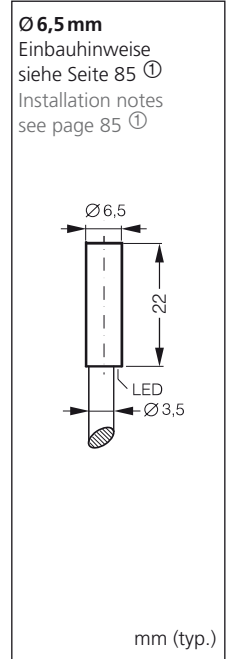
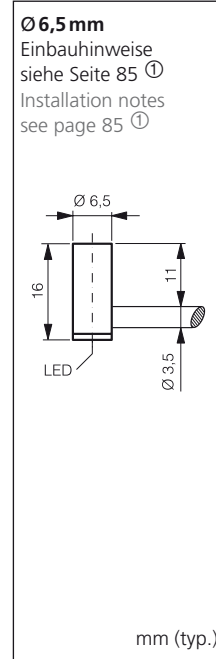
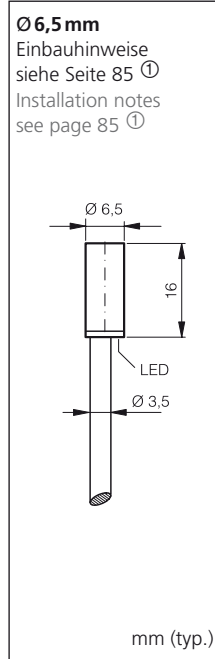
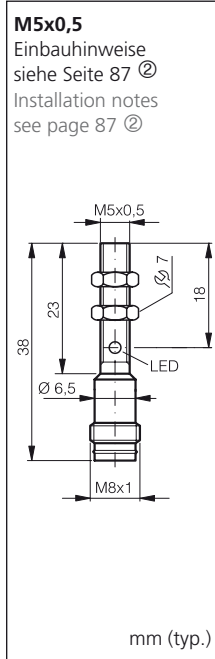
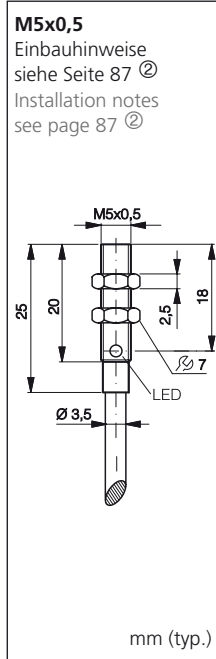
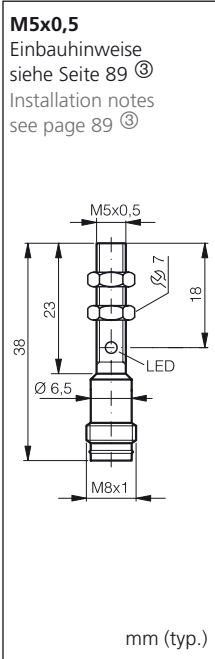
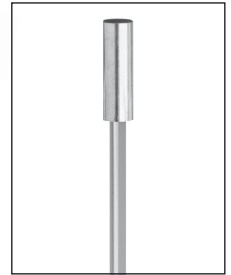
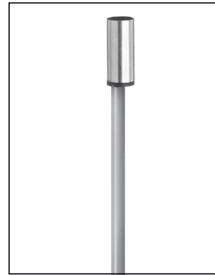
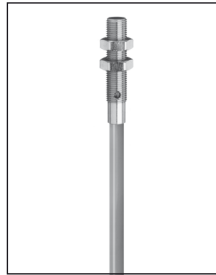
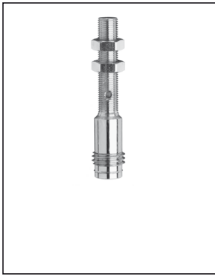

1,5 mm	2,5 mm	2,5 mm	1,5 mm	1,5 mm	1,5 mm
5x5x1 mm	7,5x7,5x1 mm	7,5x7,5x1 mm	6,5x6,5x1 mm	6,5x6,5x1 mm	6,5x6,5x1 mm
10 ... 30VDC	10 ... 30VDC	10 ... 30VDC	10 ... 30VDC	10 ... 30VDC	10 ... 30VDC
200 mA	200 mA	200 mA	200 mA	200 mA	200 mA
< 10 mA	< 10 mA	< 10 mA	< 10 mA	< 10 mA	< 10 mA
< 2,0 V	< 2,0 V	< 2,0 V	< 2,0 V	< 2,0 V	< 2,0 V
3.000 Hz	800 Hz	800 Hz	5.000 Hz	5.000 Hz	5.000 Hz
5 %	10 %	10 %	5 %	5 %	5 %
-25 ... +70 °C	-25 ... +70 °C	-25 ... +70 °C	-25 ... +70 °C	-25 ... +70 °C	-25 ... +70 °C
500 V	500 V	500 V	500 V	500 V	500 V
IP 67	IP 67	IP 67	IP 67	IP 67	IP 67
VA	VA	VA	VA	VA	VA
-	2.0 m, PVC	-	2.0 m, PVC	2.0 m, PVC	2.0 m, PVC

DCC 05 V 1.5 PSK-TSL	DCC 05 V 2.5 PSLK	DCC 05 V 2.5 PSK-TSL	DCCK 6.5 V 1.5 PSLK	DCCKR 6.5 V 1.5 PSLK	DCC 6.5 V 1.5 PSLK/22
DCC 05 V 1.5 POK-TSL	DCC 05 V 2.5 POLK	DCC 05 V 2.5 POK-TSL	DCCK 6.5 V 1.5 POLK	DCCKR 6.5 V 1.5 POLK	DCC 6.5 V 1.5 POLK/22
-	-	-	-	-	-
-	-	-	-	-	-
-	-	-	-	-	-
-	-	-	-	-	-
-	-	-	-	-	-
-	-	-	-	-	-
TK...	-	TK...	-	-	-
-	-	-	-	-	-

Induktive Näherungsschalter | Inductive proximity switches

b 1,5 mm

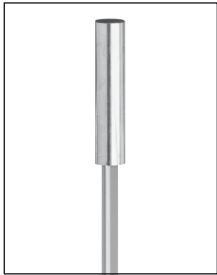

b 1,5 mm



b 1,5 mm

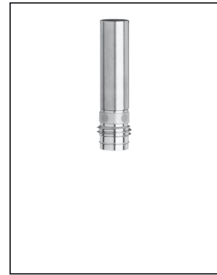

b 1,5 mm

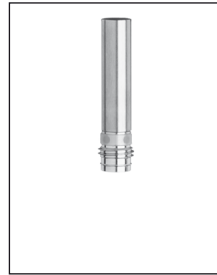

b 1,5 mm

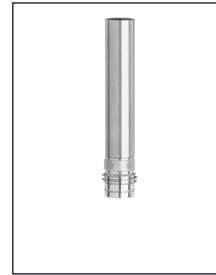

b 1,5 mm



Ø6,5 mm
Einbauhinweise
siehe Seite 85 ①
Installation notes
see page 85 ①

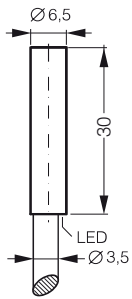

mm (typ.)

Ø6,5 mm
Einbauhinweise
siehe Seite 85 ①
Installation notes
see page 85 ①

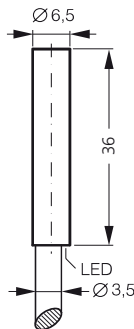

mm (typ.)

Ø6,5 mm
Einbauhinweise
siehe Seite 85 ①
Installation notes
see page 85 ①

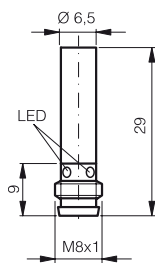

mm (typ.)

Ø6,5 mm
Einbauhinweise
siehe Seite 85 ①
Installation notes
see page 85 ①

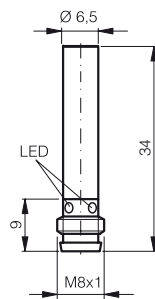

mm (typ.)

Ø6,5 mm
Einbauhinweise
siehe Seite 85 ①
Installation notes
see page 85 ①

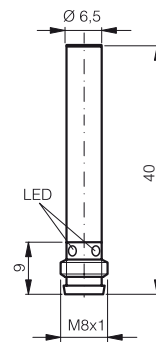

mm (typ.)

Ø6,5 mm
Einbauhinweise
siehe Seite 85 ①
Installation notes
see page 85 ①

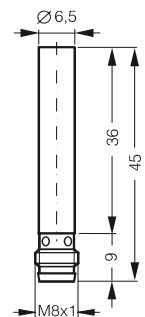

mm (typ.)

1,5 mm	1,5 mm	1,5 mm	1,5 mm	1,5 mm	1,5 mm
6,5x6,5x1 mm	6,5x6,5x1 mm	6,5x6,5x1 mm	6,5x6,5x1 mm	6,5x6,5x1 mm	6,5x6,5x1 mm
10 ... 30VDC	10 ... 30VDC	10 ... 30VDC	10 ... 30VDC	10 ... 30VDC	10 ... 30VDC
200 mA	200 mA	200 mA	200 mA	200 mA	200 mA
< 10 mA	< 10 mA	< 10 mA	< 10 mA	< 10 mA	< 10 mA
< 2,0 V	< 2,0 V	< 2,0 V	< 2,0 V	< 2,0 V	< 2,0 V
5.000 Hz	5.000 Hz	5.000 Hz	5.000 Hz	5.000 Hz	5.000 Hz
5 %	5 %	5 %	5 %	5 %	5 %
-25 ... +70 °C	-25 ... +70 °C	-25 ... +70 °C	-25 ... +70 °C	-25 ... +70 °C	-25 ... +70 °C
500 V	500 V	500 V	500 V	500 V	500 V
IP 67	IP 67	IP 67	IP 67	IP 67	IP 67
VA	VA	VA	VA	VA	VA
2.0 m, PVC	2.0 m, PVC	-	-	-	-

DCC 6.5 V 1.5 PSLK/30	DCC 6.5 V 1.5 PSLK	DCCK 6.5 V 1.5 PSK-TSL	DCC 6.5 V 1.5 PSK-TSL/34	DCC 6.5 V 1.5 PSK-TSL/40	DCC 6.5 V 1.5 PSK-TSL
DCC 6.5 V 1.5 POLK/30	DCC 6.5 V 1.5 POLK	DCCK 6.5 V 1.5 POK-TSL	DCC 6.5 V 1.5 POK-TSL/34	DCC 6.5 V 1.5 POK-TSL/40	DCC 6.5 V 1.5 POK-TSL
-	-	-	-	-	-
-	-	-	-	-	-
-	-	-	-	-	-
-	-	-	-	-	-
-	-	-	-	-	-
-	-	-	-	-	-
-	-	TK...	TK...	TK...	TK...
-	-	-	-	-	-

b 1,5 mm



b 2 mm

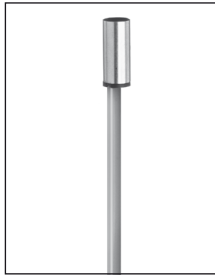

b 2 mm



b 2 mm

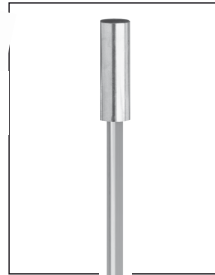

b 2 mm

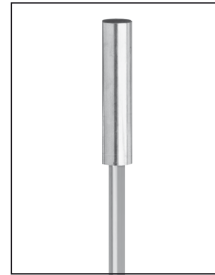

b 2 mm



Ø6,5 mm

Einbauhinweise
siehe Seite 85 ①
Installation notes
see page 85 ①

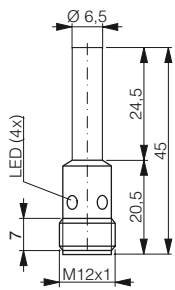

mm (typ.)

Ø6,5 mm

Einbauhinweise
siehe Seite 89 ③
Installation notes
see page 89 ③

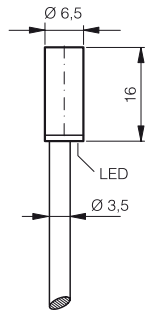

mm (typ.)

Ø6,5 mm

Einbauhinweise
siehe Seite 89 ③
Installation notes
see page 89 ③

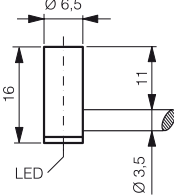

mm (typ.)

Ø6,5 mm

Einbauhinweise
siehe Seite 89 ③
Installation notes
see page 89 ③

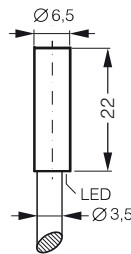

mm (typ.)

Ø6,5 mm

Einbauhinweise
siehe Seite 89 ③
Installation notes
see page 89 ③

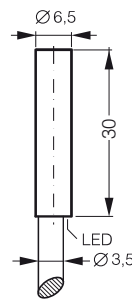

mm (typ.)

Ø6,5 mm

Einbauhinweise
siehe Seite 89 ③
Installation notes
see page 89 ③

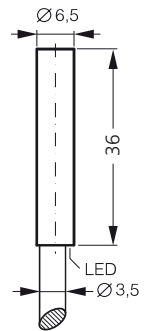

mm (typ.)

1,5mm	2 mm	2 mm	2 mm	2 mm	2 mm
6,5x6,5x1 mm	6,5x6,5x1 mm	6,5x6,5x1 mm	6,5x6,5x1 mm	6,5x6,5x1 mm	6,5x6,5x1 mm
10 ... 30VDC	10 ... 30VDC	10 ... 30VDC	10 ... 30VDC	10 ... 30VDC	10 ... 30VDC
200 mA	200 mA	200 mA	200 mA	200 mA	200 mA
< 10 mA	< 10 mA	< 10 mA	< 10 mA	< 10 mA	< 10 mA
< 2,0 V	< 2,0 V	< 2,0 V	< 2,0 V	< 2,0 V	< 2,0 V
5.000 Hz	5.000 Hz	5.000 Hz	5.000 Hz	5.000 Hz	5.000 Hz
5 %	5 %	5 %	5 %	5 %	5 %
-25 ... +70 °C	-25 ... +70 °C	-25 ... +70 °C	-25 ... +70 °C	-25 ... +70 °C	-25 ... +70 °C
500 V	500 V	500 V	500 V	500 V	500 V
IP 67	IP 67	IP 67	IP 67	IP 67	IP 67
VA	VA	VA	VA	VA	VA
-	2.0m, PVC	2.0m, PVC	2.0m, PVC	2.0m, PVC	2.0m, PVC

DCC 6.5 V 1.5 PSK-IBSL	DCCK 6.5 V 02 PSLK	DCCKR 6.5 V 02 PSLK	DCC 6.5 V 02 PSLK/22	DCC 6.5 V 02 PSLK/30	DCC 6.5 V 02 PSLK
DCC 6.5 V 1.5 POK-IBSL	DCCK 6.5 V 02 POLK	DCCKR 6.5 V 02 POLK	DCC 6.5 V 02 POLK/22	DCC 6.5 V 02 POLK/30	DCC 6.5 V 02 POLK

-	-	-	-	-	-
-	-	-	-	-	-
-	-	-	-	-	-
-	-	-	-	-	-
-	-	-	-	-	-

VK...	(Schließer / NO)	-	-	-	-
VK.../4	(Öffner / NC)	-	-	-	-

Induktive Näherungsschalter | Inductive proximity switches

b 2 mm

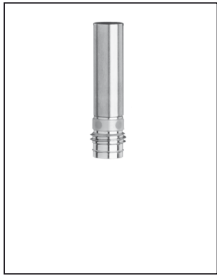

b 2 mm

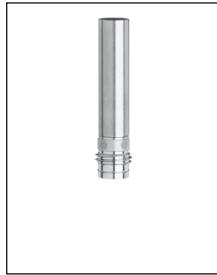

b 2 mm

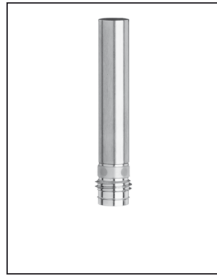

b 2 mm



b 2 mm



qb 3 mm

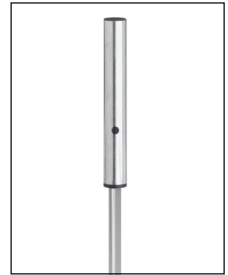

Ø 6,5 mm
Einbauhinweise
siehe Seite 89 ③
Installation notes
see page 89 ③

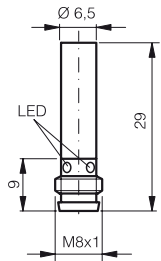

mm (typ.)

Ø 6,5 mm
Einbauhinweise
siehe Seite 89 ③
Installation notes
see page 89 ③

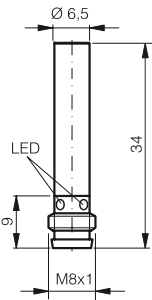

mm (typ.)

Ø 6,5 mm
Einbauhinweise
siehe Seite 89 ③
Installation notes
see page 89 ③

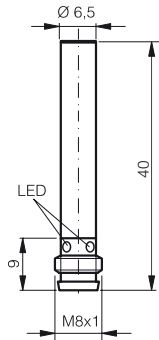

mm (typ.)

Ø 6,5 mm
Einbauhinweise
siehe Seite 89 ③
Installation notes
see page 89 ③

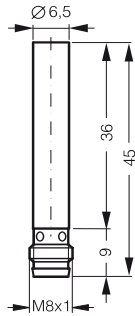

mm (typ.)

Ø 6,5 mm
Einbauhinweise
siehe Seite 89 ③
Installation notes
see page 89 ③

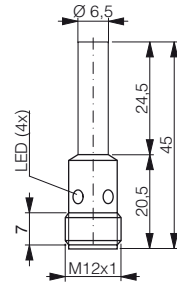

mm (typ.)

Ø 6,5 mm
Einbauhinweise
siehe Seite 87 ②
Installation notes
see page 87 ②

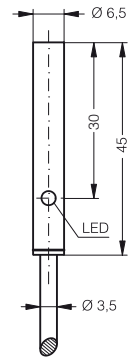

mm (typ.)

2 mm	2 mm	2 mm	2 mm	2 mm	3 mm
6,5x6,5x1 mm	6,5x6,5x1 mm	6,5x6,5x1 mm	6,5x6,5x1 mm	6,5x6,5x1 mm	9x9x1 mm
10 ... 30VDC	10 ... 30VDC	10 ... 30VDC	10 ... 30VDC	10 ... 30VDC	10 ... 30VDC
200 mA	200 mA	200 mA	200 mA	200 mA	200 mA
< 10 mA	< 10 mA	< 10 mA	< 10 mA	< 10 mA	< 10 mA
< 2,0 V	< 2,0 V	< 2,0 V	< 2,0 V	< 2,0 V	< 2,0 V
5.000 Hz	5.000 Hz	5.000 Hz	5.000 Hz	5.000 Hz	1.000 Hz
5 %	5 %	5 %	5 %	5 %	5 %
-25 ... +70 °C	-25 ... +70 °C	-25 ... +70 °C	-25 ... +70 °C	-25 ... +70 °C	-25 ... +70 °C
500 V	500 V	500 V	500 V	500 V	500 V
IP 67	IP 67	IP 67	IP 67	IP 67	IP 67
VA	VA	VA	VA	VA	Ms
-	-	-	-	-	2.0 m, PVC

DCC 6.5 V 02 PSK-TSL/29	DCC 6.5 V 02 PSK-TSL/34	DCC 6.5 V 02 PSK-TSL/40	DCC 6.5 V 02 PSK-TSL	DCC 6.5 V 02 PSK-IBSL	DCC 6.5 M 03 PSLK
DCC 6.5 V 02 POK-TSL/29	DCC 6.5 V 02 POK-TSL/34	DCC 6.5 V 02 POK-TSL/40	DCC 6.5 V 02 POK-TSL	DCC 6.5 V 02 POK-IBSL	DCC 6.5 M 03 POLK

-	-	-	-	-	-
-	-	-	-	-	-
-	-	-	-	-	-
-	-	-	-	-	-
-	-	-	-	-	-
-	-	-	-	-	-

TK...	TK...	TK...	TK...	VK... (Schließer / NO)	-
-	-	-	-	VK.../4 (Öffner / NC)	-

qb 3 mm

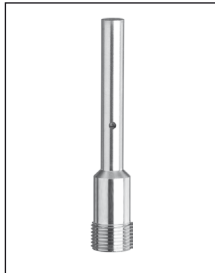
qb 3 mm

b 1,5 mm

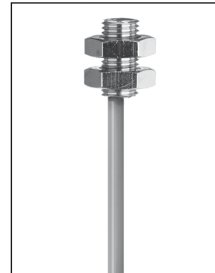
b 2 mm

b 1,5 mm

b 1,5 mm

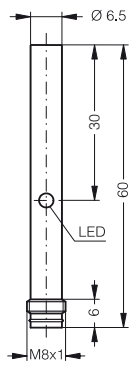
Ø6,5 mm

Einbauhinweise
siehe Seite 87 ②
Installation notes
see page 87 ②



mm (typ.)

Ø6,5 mm

Einbauhinweise
siehe Seite 87 ②
Installation notes
see page 87 ②

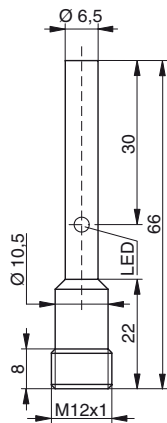

mm (typ.)

Ø8 mm

Einbauhinweise
siehe Seite 85 ①
Installation notes
see page 85 ①

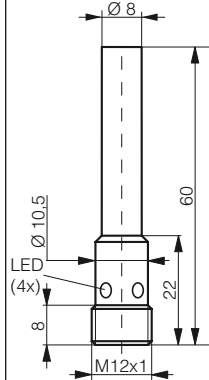

mm (typ.)

Ø8 mm

Einbauhinweise
siehe Seite 89 ③
Installation notes
see page 89 ③

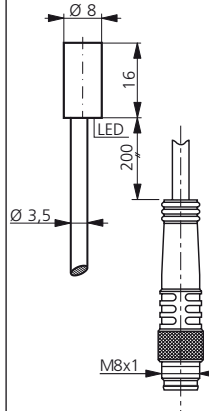

mm (typ.)

M8x1

Einbauhinweise
siehe Seite 85 ①
Installation notes
see page 85 ①

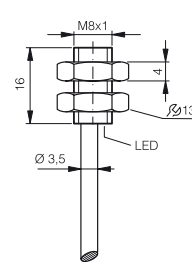

mm (typ.)

M8x1

Einbauhinweise
siehe Seite 85 ①
Installation notes
see page 85 ①

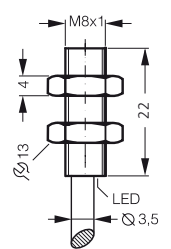

mm (typ.)

3 mm	3 mm	1,5 mm	2 mm	1,5 mm	1,5 mm
9x9x1 mm	9x9x1 mm	8x8x1 mm	8x8x1 mm	8x8x1 mm	8x8x1 mm
10...30VDC	10...30VDC	10...30VDC	10...30VDC	10...30VDC	10...30VDC
200 mA	200 mA	200 mA	200 mA	200 mA	200 mA
< 10 mA	< 10 mA	< 10 mA	< 10 mA	< 10 mA	< 10 mA
< 2,0 V	< 2,0 V	< 2,0 V	< 2,0 V	< 2,0 V	< 2,0 V
1.000 Hz	1.000 Hz	5.000 Hz	3.000 Hz	5.000 Hz	5.000 Hz
5 %	5 %	5 %	5 %	5 %	5 %
-25...+70°C	-25...+70°C	-25...+70°C	-25...+70°C	-25...+70°C	-25...+70°C
500 V	500 V	500 V	500 V	500 V	500 V
IP 67	IP 67	IP 67	IP 67	IP 67	IP 67
Ms	Ms	VA	Ms	VA	VA
-	-	-	0,2 m, PVC	2,0 m, PVC	2,0 m, PVC

DCC 6.5 M 03 PSK-TSL	DCC 6.5 M 03 PSK-IBSL	DCC 8.0 V 1.5 PSK-IBSL	DCC 8.0 M 02 PSK-KR-TSL	DCCK 08 M 1.5 PSLK	DCC 08 M 1.5 PSLK/22
DCC 6.5 M 03 POK-TSL	DCC 6.5 M 03 POK-IBSL	-	-	DCCK 08 M 1.5 POLK	DCC 08 M 1.5 POLK/22
-	-	-	-	-	-
-	-	-	-	-	-
-	-	-	-	-	-
-	-	-	-	-	-
-	-	-	-	-	-
-	-	-	-	-	-
TK...	VK... (Schließer / NO)	VK...	TK...	-	-
-	VK.../4 (Öffner / NC)	-	-	-	-

Induktive Näherungsschalter | Inductive proximity switches

b 1,5 mm



b 1,5 mm



b 1,5 mm

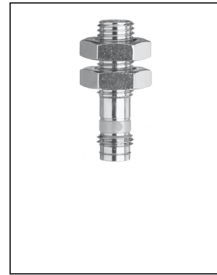

b 1,5 mm



b 1,5 mm



b 1,5 mm



M8x1
Einbauhinweise siehe Seite 85 ①
Installation notes see page 85 ①

mm (typ.)

M8x1
Einbauhinweise siehe Seite 85 ①
Installation notes see page 85 ①

mm (typ.)

M8x1
Einbauhinweise siehe Seite 85 ①
Installation notes see page 85 ①

mm (typ.)

M8x1
Einbauhinweise siehe Seite 85 ①
Installation notes see page 85 ①

mm (typ.)

M8x1
Einbauhinweise siehe Seite 85 ①
Installation notes see page 85 ①

mm (typ.)

M8x1
Einbauhinweise siehe Seite 85 ①
Installation notes see page 85 ①

mm (typ.)

1,5 mm	1,5 mm	1,5 mm	1,5 mm	1,5 mm	1,5 mm
8x8x1 mm	8x8x1 mm	8x8x1 mm	8x8x1 mm	8x8x1 mm	8x8x1 mm
10 ... 30VDC	10 ... 30VDC	10 ... 30VDC	10 ... 30VDC	10 ... 30VDC	10 ... 30VDC
200mA	200mA	200mA	200mA	200mA	200mA
< 10mA	< 10mA	< 10mA	< 10mA	< 10mA	< 10mA
< 2,0 V	< 2,0 V	< 2,0 V	< 2,0 V	< 2,0 V	< 2,0 V
5.000Hz	5.000Hz	5.000Hz	5.000Hz	5.000Hz	5.000Hz
5 %	5 %	5 %	5 %	5 %	5 %
-25 ... +70 °C	-25 ... +70 °C	-25 ... +70 °C	-25 ... +70 °C	-25 ... +70 °C	-25 ... +70 °C
500 V	500 V	500 V	500 V	500 V	500 V
IP 67	IP 67	IP 67	IP 67	IP 67	IP 67
VA	VA	VA	VA	VA	VA
2.0m, PVC	2.0m, PVC	-	-	-	-

DCC 08 M 1.5 PSLK/30	DCC 08 M 1.5 PSLK	DCCK 08 M 1.5 PSK-TSL	DCC 08 M 1.5 PSK-TSL/32	DCC 08 M 1.5 PSK-TSL/40	DCC 08 M 1.5 PSK-TSL
DCC 08 M 1.5 POLK/30	DCC 08 M 1.5 POLK	DCCK 08 M 1.5 POK-TSL	DCC 08 M 1.5 POK-TSL/32	DCC 08 M 1.5 POK-TSL/40	DCC 08 M 1.5 POK-TSL
-	-	-	-	-	-
-	-	-	-	-	-
-	-	-	-	-	-
-	-	-	-	-	-
-	-	-	-	-	-
-	-	TK...	TK...	TK...	TK...
-	-	-	-	-	-

b 1,5 mm



b 1,5 mm



b 2 mm

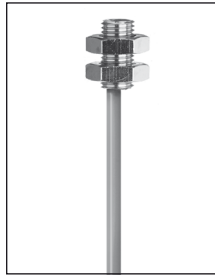

b 2 mm



b 2 mm

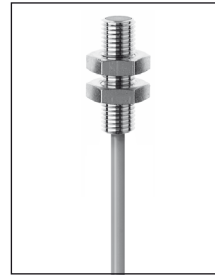

b 2 mm

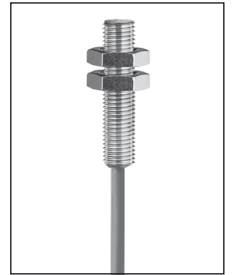

M8x1
Einbauhinweise
siehe Seite 85 ①
Installation notes
see page 85 ①

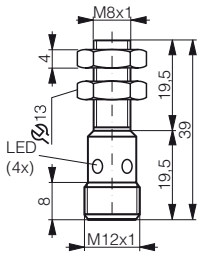

mm (typ.)

M8x1
Einbauhinweise
siehe Seite 85 ①
Installation notes
see page 85 ①

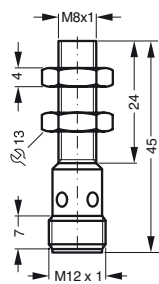

mm (typ.)

M8x1
Einbauhinweise
siehe Seite 89 ③
Installation notes
see page 89 ③

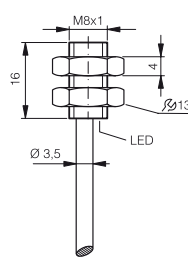

mm (typ.)

M8x1
Einbauhinweise
siehe Seite 89 ③
Installation notes
see page 89 ③

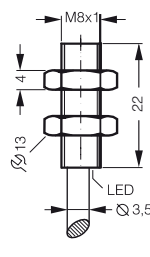

mm (typ.)

M8x1
Einbauhinweise
siehe Seite 89 ③
Installation notes
see page 89 ③

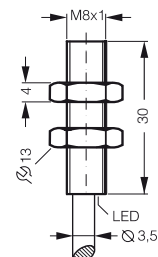

mm (typ.)

M8x1
Einbauhinweise
siehe Seite 89 ③
Installation notes
see page 89 ③

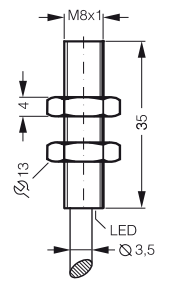

mm (typ.)

1,5mm	1,5mm	2mm	2mm	2mm	2mm
8x8x1 mm	8x8x1 mm	8x8x1 mm	8x8x1 mm	8x8x1 mm	8x8x1 mm
10 ... 30VDC	10 ... 30VDC	10 ... 30VDC	10 ... 30VDC	10 ... 30VDC	10 ... 30VDC
200mA	200mA	200mA	200mA	200mA	200mA
< 10mA	< 10mA	< 10mA	< 10mA	< 10mA	< 10mA
< 2,0 V	< 2,0 V	< 2,0 V	< 2,0 V	< 2,0 V	< 2,0 V
5.000Hz	5.000Hz	5.000Hz	5.000Hz	5.000Hz	5.000Hz
5 %	5 %	5 %	5 %	5 %	5 %
-25 ... +70°C	-25 ... +70°C	-25 ... +70°C	-25 ... +70°C	-25 ... +70°C	-25 ... +70°C
500 V	500 V	500 V	500 V	500 V	500 V
IP 67	IP 67	IP 67	IP 67	IP 67	IP 67
VA	VA	VA	VA	VA	VA
-	-	2,0m, PVC	2,0m, PVC	2,0m, PVC	2,0m, PVC

DCC 08 M 1.5 PSK-IBSL/39	DCC 08 M 1.5 PSK-IBSL	DCC 08 M 02 PSLK/16	DCC 08 M 02 PSLK/22	DCC 08 M 02 PSLK/30	DCC 08 M 02 PSLK
-	DCC 08 M 1.5 POK-IBSL	DCC 08 M 02 POLK/16	DCC 08 M 02 POLK/22	DCC 08 M 02 POLK/30	DCC 08 M 02 POLK
-	-	-	-	-	-
-	-	-	-	-	-
-	-	-	-	-	-
-	-	-	-	-	-
-	-	-	-	-	-
-	-	-	-	-	-
VK...	VK... (Schließer / NO)	-	-	-	-
-	VK.../4 (Öffner / NC)	-	-	-	-

Induktive Näherungsschalter | Inductive proximity switches

b 2 mm



b 2 mm



b 2 mm



b 2 mm



b 2 mm



nb 2,5 mm

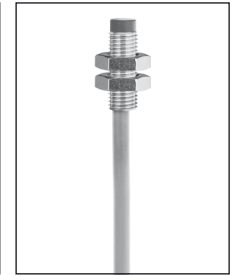

M8x1
Einbauhinweise siehe Seite 89 ③
Installation notes see page 89 ③

mm (typ.)

M8x1
Einbauhinweise siehe Seite 89 ③
Installation notes see page 89 ③

mm (typ.)

M8x1
Einbauhinweise siehe Seite 89 ③
Installation notes see page 89 ③

mm (typ.)

M8x1
Einbauhinweise siehe Seite 89 ③
Installation notes see page 89 ③

mm (typ.)

M8x1
Einbauhinweise siehe Seite 89 ③
Installation notes see page 89 ③

mm (typ.)

M8x1
Einbauhinweise siehe Seite 85 ①
Installation notes see page 85 ①

mm (typ.)

2 mm	2 mm	2 mm	2 mm	2 mm	2,5 mm
8x8x1 mm	8x8x1 mm	8x8x1 mm	8x8x1 mm	8x8x1 mm	8x8x1 mm
10 ... 30VDC	10 ... 30VDC	10 ... 30VDC	10 ... 30VDC	10 ... 30VDC	10 ... 30VDC
200 mA	200 mA	200 mA	200 mA	200 mA	200 mA
< 10 mA	< 10 mA	< 10 mA	< 10 mA	< 10 mA	< 10 mA
< 2,0 V	< 2,0 V	< 2,0 V	< 2,0 V	< 2,0 V	< 2,0 V
5.000 Hz	5.000 Hz	5.000 Hz	5.000 Hz	5.000 Hz	4.500 Hz
5 %	5 %	5 %	5 %	5 %	5 %
-25 ... +70 °C	-25 ... +70 °C	-25 ... +70 °C	-25 ... +70 °C	-25 ... +70 °C	-25 ... +70 °C
500 V	500 V	500 V	500 V	500 V	500 V
IP 67	IP 67	IP 67	IP 67	IP 67	IP 67
VA	VA	VA	VA	VA	VA
-	-	-	-	-	2.0 m, PVC

DCC 08 M 02 PSK-TSL/29	DCC 08 M 02 PSK-TSL/32	DCC 08 M 02 PSK-TSL/40	DCC 08 M 02 PSK-TSL	DCC 08 M 02 PSK-IBSL	DCC 08 V 2.5 PSLK/22
DCC 08 M 02 POK-TSL/29	DCC 08 M 02 POK-TSL/32	DCC 08 M 02 POK-TSL/40	DCC 08 M 02 POK-TSL	DCC 08 M 02 POK-IBSL	DCC 08 V 2.5 POLK/22
-	-	-	-	-	-
-	-	-	-	-	-
-	-	-	-	-	-
-	-	-	-	-	-
-	-	-	-	-	-
TK...	TK...	TK...	TK...	VK... (Schließer / NO)	-
-	-	-	-	VK.../4 (Öffner / NC)	-

nb 2,5 mm

nb 2,5 mm

nb 2,5 mm

nb 2,5 mm

nb 2,5 mm

nb 2,5 mm



M8x1

Einbauhinweise
siehe Seite 85 ①
Installation notes
see page 85 ①

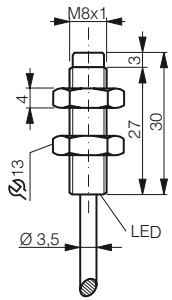

mm (typ.)

M8x1

Einbauhinweise
siehe Seite 85 ①
Installation notes
see page 85 ①

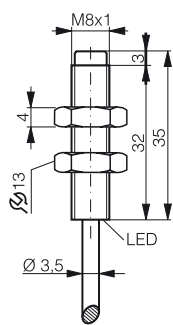

mm (typ.)

M8x1

Einbauhinweise
siehe Seite 85 ①
Installation notes
see page 85 ①

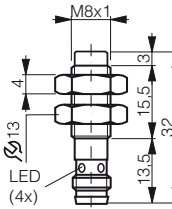

mm (typ.)

M8x1

Einbauhinweise
siehe Seite 85 ①
Installation notes
see page 85 ①

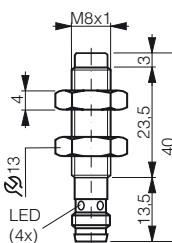

mm (typ.)

M8x1

Einbauhinweise
siehe Seite 85 ①
Installation notes
see page 85 ①

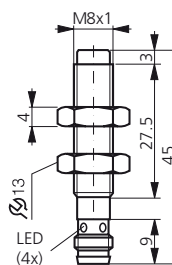

mm (typ.)

M8x1

Einbauhinweise
siehe Seite 85 ①
Installation notes
see page 85 ①

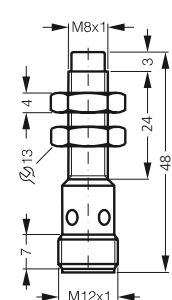

mm (typ.)

2,5mm	2,5 mm	2,5mm	2,5 mm	2,5mm	2,5 mm
8x8x 1 mm	8x8x1 mm	8x8x 1 mm	8x8x1 mm	8x8x 1 mm	8x8x1 mm
10 ... 30VDC	10 ... 30VDC	10 ... 30VDC	10 ... 30VDC	10 ... 30VDC	10 ... 30VDC
200 mA	200 mA	200 mA	200 mA	200 mA	200 mA
< 10 mA	< 10 mA	< 10 mA	< 10 mA	< 10 mA	< 10 mA
< 2,0 V	< 2,0 V	< 2,0 V	< 2,0 V	< 2,0 V	< 2,0 V
4.500 Hz	4.500 Hz	4.500 Hz	4.500 Hz	4.500 Hz	4.500 Hz
5 %	5 %	5 %	5 %	5 %	5 %
-25 ... +70 °C	-25 ... +70 °C	-25 ... +70 °C	-25 ... +70 °C	-25 ... +70 °C	-25 ... +70 °C
500 V	500 V	500 V	500 V	500 V	500 V
IP 67	IP 67	IP 67	IP 67	IP 67	IP 67
VA	VA	VA	VA	VA	VA
2.0m, PVC	2.0m, PVC	-	-	-	-

DCC 08 V 2.5 PSLK/30	DCC 08 M 2.5 PSLK	DCC 08 V 2.5 PSK-TSL/32	DCC 08 V 2.5 PSK-TSL/40	DCC 08 M 2.5 PSK-TSL	DCC 08 M 2.5 PSK-IBSL
DCC 08 V 2.5 POLK/30	DCC 08 M 2.5 POLK	DCC 08 V 2.5 POK-TSL/32	DCC 08 V 2.5 POK-TSL/40	DCC 08 M 2.5 POK-TSL	DCC 08 M 2.5 POK-IBSL
-	-	-	-	-	-
-	-	-	-	-	-
-	-	-	-	-	-
-	-	-	-	-	-
-	-	-	-	-	-
-	-	TK...	TK...	TK...	VK... (Schließer / NO)
-	-	-	-	-	VK.../4 (Öffner / NC)

Induktive Näherungsschalter | Inductive proximity switches

b 3 mm



b 3 mm



b 3 mm



b 3 mm



qb 4 mm

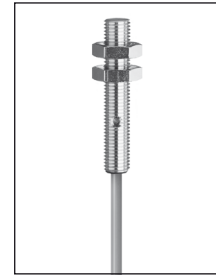

qb 4 mm

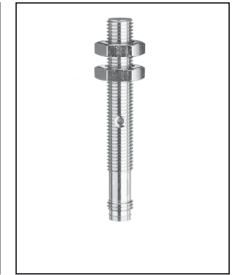

M8x1
Einbauhinweise
siehe Seite 87 ②
Installation notes
see page 87 ②

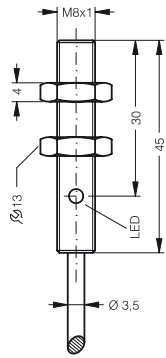

mm (typ.)

M8x1
Einbauhinweise
siehe Seite 87 ②
Installation notes
see page 87 ②

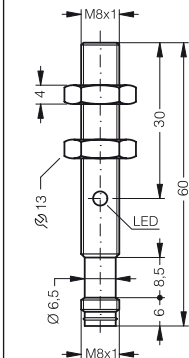

mm (typ.)

M8x1
Einbauhinweise
siehe Seite 87 ②
Installation notes
see page 87 ②

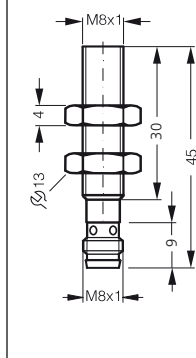

mm (typ.)

M8x1
Einbauhinweise
siehe Seite 87 ②
Installation notes
see page 87 ②

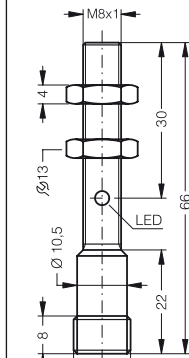

mm (typ.)

M8x1
Einbauhinweise
siehe Seite 96 ①
Installation notes
see page 96 ①

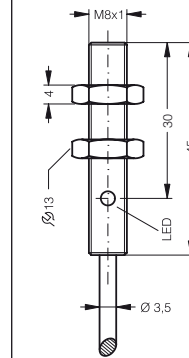

mm (typ.)

M8x1
Einbauhinweise
siehe Seite 96 ①
Installation notes
see page 96 ①

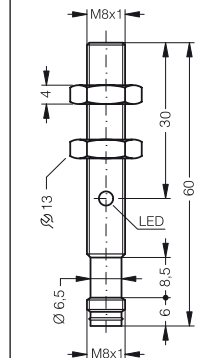

mm (typ.)

3 mm	3 mm	3 mm	3 mm	4 mm	4 mm
9x9x1 mm	9x9x1 mm	9x9x1 mm	9x9x1 mm	16x16x1 mm	16x16x1 mm
10 ... 30VDC	10 ... 30VDC	10 ... 30VDC	10 ... 30VDC	10 ... 30VDC	10 ... 30VDC
200 mA	200 mA	200 mA	200 mA	200 mA	200 mA
< 10 mA	< 10 mA	< 10 mA	< 10 mA	< 10 mA	< 10 mA
< 2,0 V	< 2,0 V	< 2,0 V	< 2,0 V	< 2,0 V	< 2,0 V
1.000 Hz	1.000 Hz	3.000 Hz	1.000 Hz	500 Hz	500 Hz
5 %	5 %	10 %	5 %	10 %	10 %
-25 ... +70 °C	-25 ... +70 °C	-25 ... +70 °C	-25 ... +70 °C	-25 ... +70 °C	-25 ... +70 °C
500 V	500 V	1000 V	500 V	500 V	500 V
IP 67	IP 67	IP 67	IP 67	IP 67	IP 67
Ms	Ms	V2A	Ms	Ms	Ms
2.0 m, PVC	-	-	-	2.0 m, PVC	-

DCC 08 M 03 PSLK	DCC 08 M 03 PSK-TSL	DCC 08 V 03 PSK-TSL	DCC 08 M 03 PSK-IBSL	DCC 08 M 04 PSLK	DCC 08 M 04 PSK-TSL
DCC 08 M 03 POLK	DCC 08 M 03 POK-TSL	-	DCC 08 M 03 POK-IBSL	DCC 08 M 04 POLK	DCC 08 M 04 POK-TSL
-	-	-	-	-	-
-	-	-	-	-	-
-	-	-	-	-	-
-	-	-	-	-	-
-	-	-	-	-	-
-	TK...	TK...	VK... (Schließer / NO)	-	TK...
-	-	-	VK.../4 (Öffner / NC)	-	-

qb 4 mm

nb 4 mm

nb 4 mm

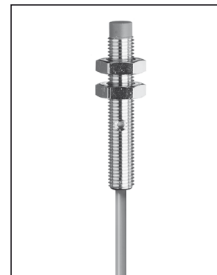
nb 6 mm

nb 6 mm

nb 6 mm

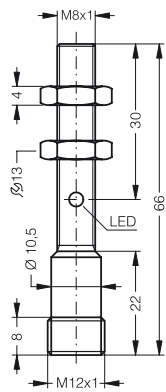
M8x1
Einbauhinweise
siehe Seite 96 ^①
Installation notes
see page 96 ^①



mm (typ.)

M8x1
Einbauhinweise
siehe Seite 98 ^⑬
Installation notes
see page 98 ^⑬

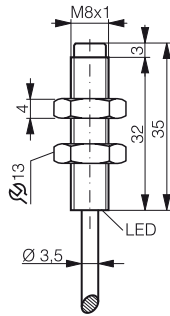

mm (typ.)

M8x1
Einbauhinweise
siehe Seite 98 ^⑬
Installation notes
see page 98 ^⑬

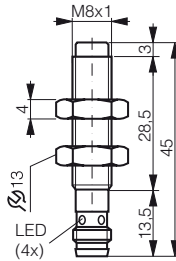

mm (typ.)

M8x1
Einbauhinweise
siehe Seite 87 ^②
Installation notes
see page 87 ^②

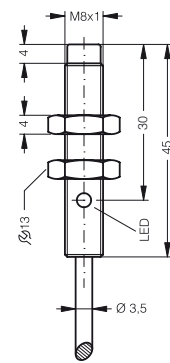

mm (typ.)

M8x1
Einbauhinweise
siehe Seite 87 ^②
Installation notes
see page 87 ^②

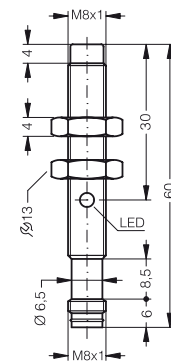

mm (typ.)

M8x1
Einbauhinweise
siehe Seite 87 ^②
Installation notes
see page 87 ^②

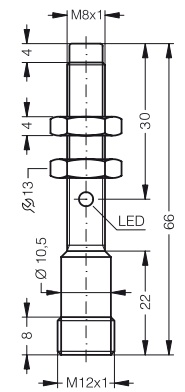

mm (typ.)

4 mm	4 mm	4 mm	6 mm	6 mm	6 mm
16 x 16 x 1 mm	12 x 12 x 1 mm	12 x 12 x 1 mm	18 x 18 x 1 mm	18 x 18 x 1 mm	18 x 18 x 1 mm
10 ... 30VDC	10 ... 30VDC	10 ... 30VDC	10 ... 30VDC	10 ... 30VDC	10 ... 30VDC
200 mA	200 mA	200 mA	200 mA	200 mA	200 mA
< 10 mA	< 10 mA	< 10 mA	< 10 mA	< 10 mA	< 10 mA
< 2,0 V	< 2,0 V	< 2,0 V	< 2,0 V	< 2,0 V	< 2,0 V
500 Hz	3.000 Hz	3.000 Hz	500 Hz	500 Hz	500 Hz
10 %	5 %	5 %	5 %	5 %	5 %
-25 ... +70 °C	-25 ... +70 °C	-25 ... +70 °C	-25 ... +70 °C	-25 ... +70 °C	-25 ... +70 °C
500 V	500 V	500 V	500 V	500 V	500 V
IP 67	IP 67	IP 67	IP 67	IP 67	IP 67
Ms	VA	VA	Ms	Ms	Ms
-	2.0 m, PVC	-	2.0 m, PVC	-	-

DCC 08 M 04 PSK-IBSL	DCC 08 V 04NB PSLK	DCC 08 V 04NB PSK-TSL	DCC 08 M 06 PSLK	DCC 08 M 06 PSK-TSL	DCC 08 M 06 PSK-IBSL
DCC 08 M 04 POK-IBSL	DCC 08 V 04NB POLK	DCC 08 V 04NB POK-TSL	DCC 08 M 06 POLK	DCC 08 M 06 POK-TSL	DCC 08 M 06 POK-IBSL
-	-	-	-	-	-
-	-	-	-	-	-
-	-	-	-	-	-
-	-	-	-	-	-
-	-	-	-	-	-

VK...	(Schließer / NO)	-	TK...	-	TK...	VK...	(Schließer / NO)
VK.../4	(Öffner / NC)	-	-	-	-	VK.../4	(Öffner / NC)

Induktive Näherungsschalter | Inductive proximity switches

b 2 mm

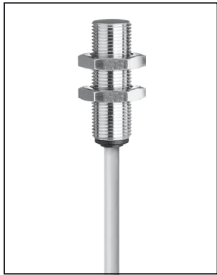

b 2 mm

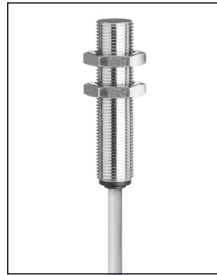

b 2 mm



b 2 mm



nb 4 mm

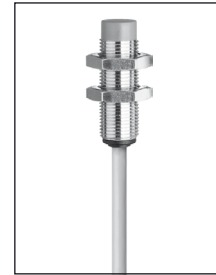

nb 4 mm



M12x1
Einbauhinweise siehe Seite 85 ①
Installation notes see page 85 ①

mm (typ.)

M12x1
Einbauhinweise siehe Seite 85 ①
Installation notes see page 85 ①

mm (typ.)

M12x1
Einbauhinweise siehe Seite 85 ①
Installation notes see page 85 ①

mm (typ.)

M12x1
Einbauhinweise siehe Seite 85 ①
Installation notes see page 85 ①

mm (typ.)

M12x1
Einbauhinweise siehe Seite 85 ①
Installation notes see page 85 ①

mm (typ.)

M12x1
Einbauhinweise siehe Seite 85 ①
Installation notes see page 85 ①

mm (typ.)

2 mm	2 mm	2 mm	2 mm	4 mm	4 mm
12 x 12 x 1 mm	12 x 12 x 1 mm	12 x 12 x 1 mm	12 x 12 x 1 mm	12 x 12 x 1 mm	12 x 12 x 1 mm
10 ... 30 VDC	10 ... 30 VDC	10 ... 30 VDC	10 ... 30 VDC	10 ... 30 VDC	10 ... 30 VDC
200 mA	200 mA	200 mA	200 mA	200 mA	200 mA
< 10 mA	< 10 mA	< 10 mA	< 10 mA	< 10 mA	< 10 mA
< 2,0 V	< 2,0 V	< 2,0 V	< 2,0 V	< 2,0 V	< 2,0 V
3.000 Hz	3.000 Hz	3.000 Hz	3.000 Hz	2.000 Hz	2.000 Hz
10 %	10 %	10 %	10 %	10 %	10 %
-25 ... +70 °C	-25 ... +70 °C	-25 ... +70 °C	-25 ... +70 °C	-25 ... +70 °C	-25 ... +70 °C
500 V	500 V	500 V	500 V	500 V	500 V
IP 67	IP 67	IP 67	IP 67	IP 67	IP 67
Ms	Ms	Ms	Ms	Ms	Ms
2.0 m, PVC	2.0 m, PVC	-	-	2.0 m, PVC	2.0 m, PVC

DCCK 12 M 02 PSLK	DCC 12 M 02 PSLK	DCCK 12 M 02 PSK-IBSL	DCC 12 M 02 PSK-IBSL	DCCK 12 M 04 PSLK	DCC 12 M 04 PSLK
DCCK 12 M 02 POLK	DCC 12 M 02 POLK	DCCK 12 M 02 POK-IBSL	DCC 12 M 02 POK-IBSL	DCCK 12 M 04 POLK	DCC 12 M 04 POLK
-	-	-	-	-	-
-	-	-	-	-	-
-	-	-	-	-	-
-	-	-	-	-	-
-	-	-	-	-	-
-	-	VK... (Schließer / NO)	VK... (Schließer / NO)	-	-
-	-	VK.../4 (Öffner / NC)	VK.../4 (Öffner / NC)	-	-

nb 4 mm

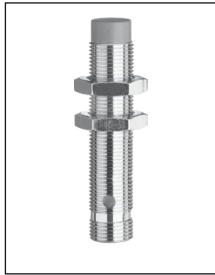
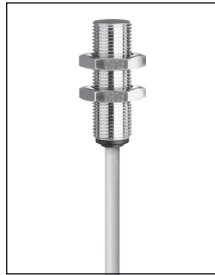
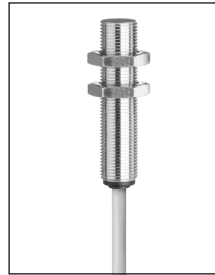
nb 4 mm

b 4 mm

b 4 mm

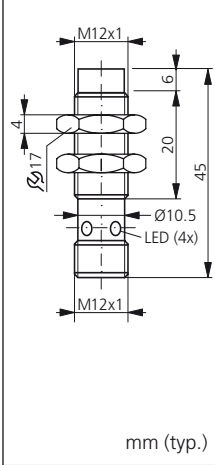
b 4 mm

b 4 mm

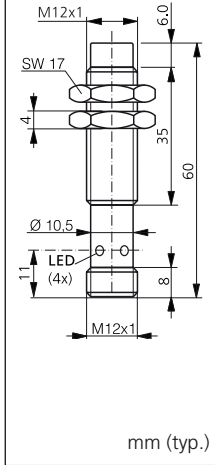

M12x1
Einbauhinweise
siehe Seite 85 ①
Installation notes
see page 85 ①



M12x1
Einbauhinweise
siehe Seite 85 ①
Installation notes
see page 85 ①

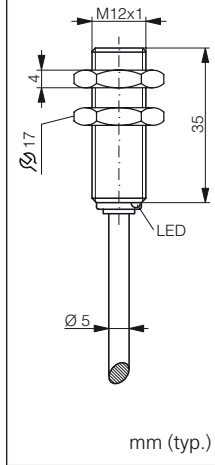

M12x1
Einbauhinweise
siehe Seite 89 ③
Installation notes
see page 89 ③



M12x1
Einbauhinweise
siehe Seite 89 ③
Installation notes
see page 89 ③

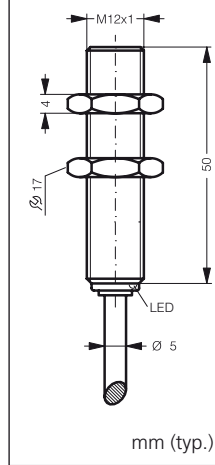

M12x1
Einbauhinweise
siehe Seite 89 ③
Installation notes
see page 89 ③

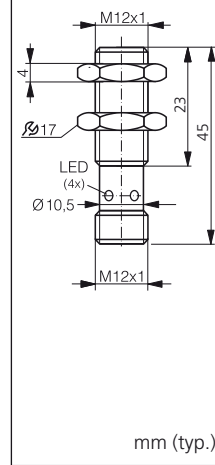

M12x1
Einbauhinweise
siehe Seite 89 ③
Installation notes
see page 89 ③

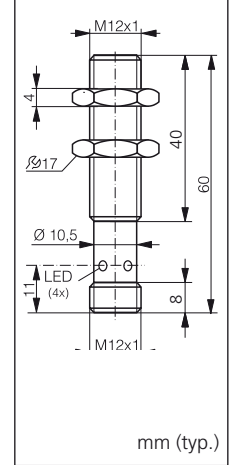

4 mm	4 mm	4 mm	4 mm	4 mm	4 mm
12 x 12 x 1 mm	12 x 12 x 1 mm	12 x 12 x 1 mm	12 x 12 x 1 mm	12 x 12 x 1 mm	12 x 12 x 1 mm
10 ... 30VDC	10 ... 30VDC	10 ... 30VDC	10 ... 30VDC	10 ... 30VDC	10 ... 30VDC
200 mA	200 mA	200 mA	200 mA	200 mA	200 mA
< 10 mA	< 10 mA	< 10 mA	< 10 mA	< 10 mA	< 10 mA
< 2,0 V	< 2,0 V	< 2,0 V	< 2,0 V	< 2,0 V	< 2,0 V
2.000 Hz	2.000 Hz	2.500 Hz	2.500 Hz	2.500 Hz	2.500 Hz
10 %	10 %	< 10 %	10 %	10 %	< 10 %
-25 ... +70 °C	-25 ... +70 °C	-25 ... +70 °C	-25 ... +70 °C	-25 ... +70 °C	-25 ... +70 °C
500 V	500 V	500 V	500 V	500 V	500 V
IP 67	IP 67	IP 67	IP 67	IP 67	IP 67
Ms	Ms	Ms	Ms	Ms	Ms
-	-	2.0m, PVC	2.0m, PVC	-	-

DCCK 12 M 04 PSK-IBSL	DCC 12 M 04 PSK-IBSL	DCCK 12 M 04B PSLK	DCC 12 M 04B PSLK	DCCK 12 M 04B PSK-IBSL	DCC 12 M 04B PSK-IBSL
DCCK 12 M 04 POK-IBSL	DCC 12 M 04 POK-IBSL	DCCK 12 M 04B POLK	-	DCCK 12 M 04B POK-IBSL	DCC 12 M 04B POK-IBSL
-	-	-	-	-	-
-	-	-	-	-	-
-	-	-	-	-	-
-	-	-	-	-	-
-	-	-	-	-	-
VK... (Schließer / NO)	VK... (Schließer / NO)	-	-	VK...	VK...
VK.../4 (Öffner / NC)	VK.../4 (Öffner / NC)	-	-	VK.../4	VK.../4

Induktive Näherungsschalter | Inductive proximity switches

qb 6 mm

qb 6 mm

qb 6 mm

qb 6 mm

qb 8 mm

qb 8 mm

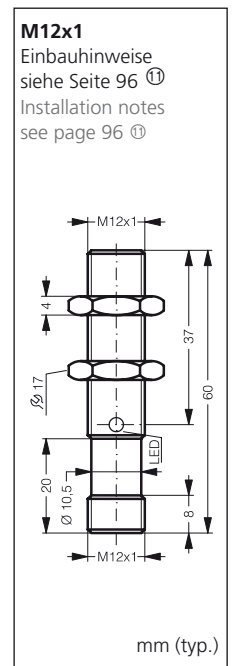
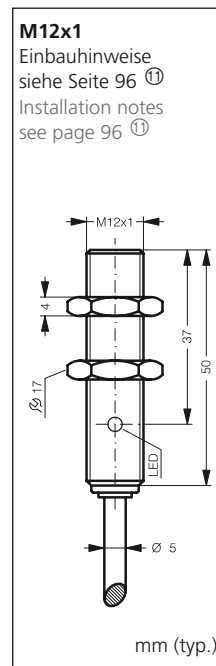
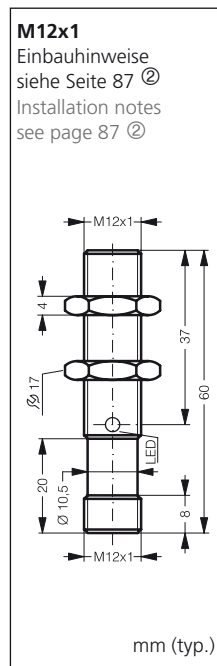
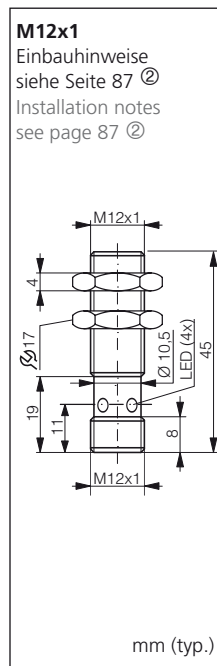
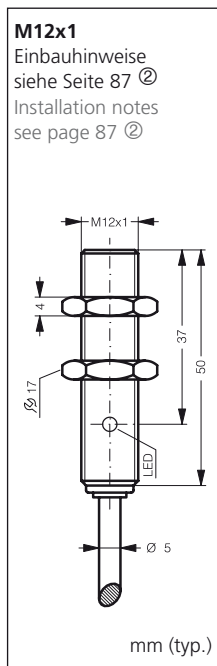
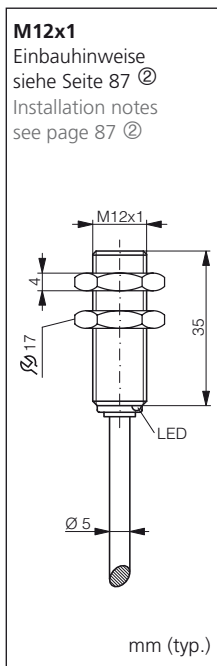
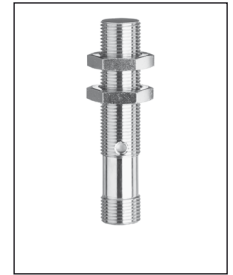
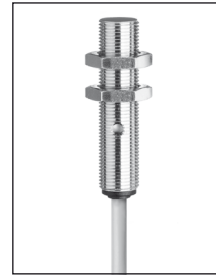
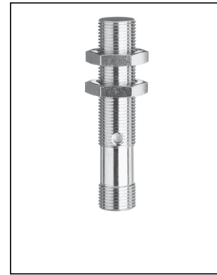
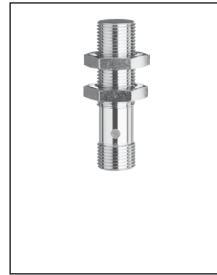
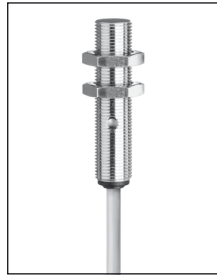
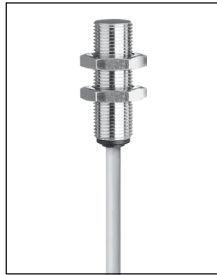

6 mm	6 mm	6 mm	6 mm	8 mm	8 mm
18x18x1 mm	18x18x1 mm	18x18x1 mm	18x18x1 mm	32x32x1 mm	32x32x1 mm
10...30VDC	10...30VDC	10...30VDC	10...30VDC	10...30VDC	10...30VDC
200mA	200mA	200mA	200mA	200mA	200mA
< 10mA	< 10mA	< 10mA	< 10mA	< 10mA	< 10mA
< 2,0 V	< 2,0 V	< 2,0 V	< 2,0 V	< 2,0 V	< 2,0 V
800Hz	800Hz	800Hz	800Hz	400Hz	400Hz
5%	5%	5%	5%	10%	10%
-25...+70°C	-25...+70°C	-25...+70°C	-25...+70°C	-25...+70°C	-25...+70°C
500 V	500 V	500 V	500 V	500 V	500 V
IP 67	IP 67	IP 67	IP 67	IP 67	IP 67
Ms	Ms	Ms	Ms	Ms	Ms
2.0m, PVC	2.0m, PVC	-	-	2.0m, PVC	-

DCCK 12 M 06 PSLK	DCC 12 M 06 PSLK	DCCK 12 M 06 PSK-IBSL	DCC 12 M 06 PSK-IBSL	DCC 12 M 08 PSLK	DCC 12 M 08 PSK-IBSL
DCCK 12 M 06 POLK	DCC 12 M 06 POLK	DCCK 12 M 06 POK-IBSL	DCC 12 M 06 POK-IBSL	DCC 12 M 08 POLK	DCC 12 M 08 POK-IBSL
-	-	-	-	-	-
-	-	-	-	-	-
-	-	-	-	-	-
-	-	-	-	-	-
-	-	-	-	-	-
-	-	VK... (Schließer / NO)	VK... (Schließer / NO)	-	VK... (Schließer / NO)
-	-	VK.../4 (Öffner / NC)	VK.../4 (Öffner / NC)	-	VK.../4 (Öffner / NC)

nb 10 mm

nb 10 mm

nb 10 mm

nb 10 mm

b 5 mm

b 5 mm

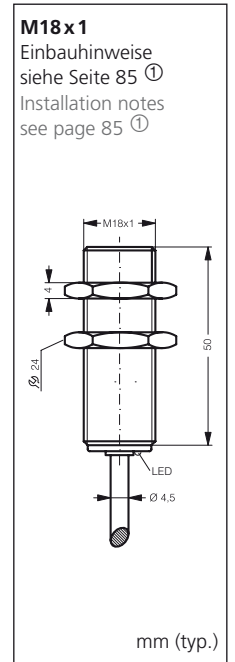
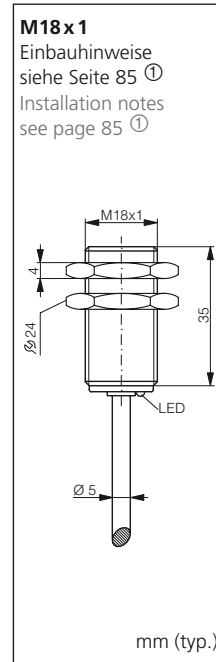
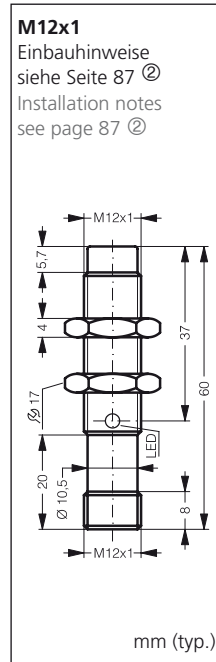
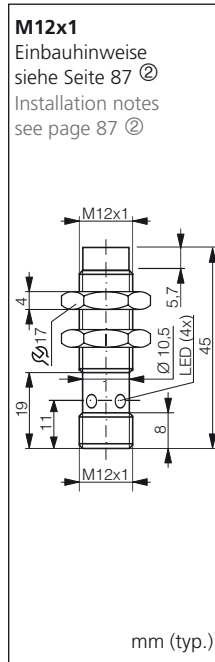
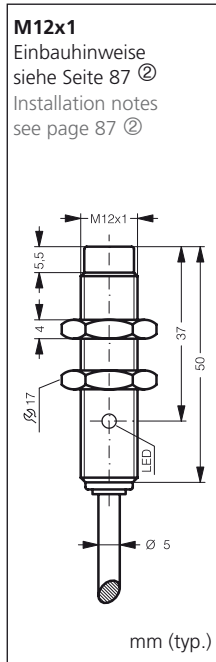
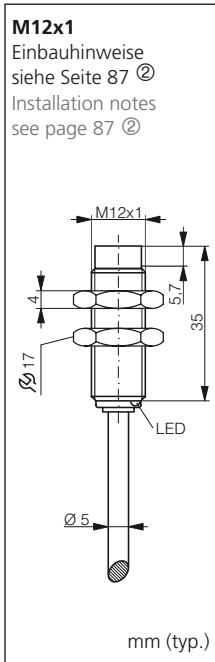
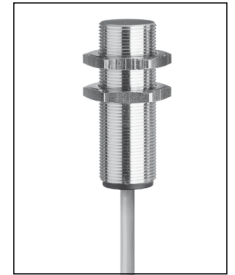
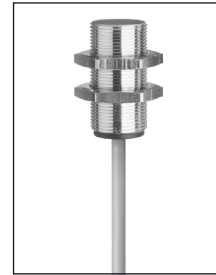
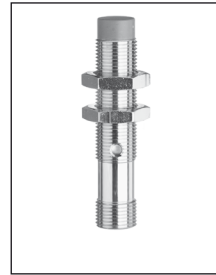
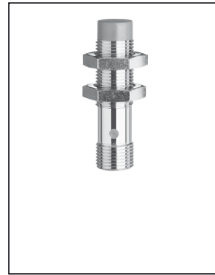
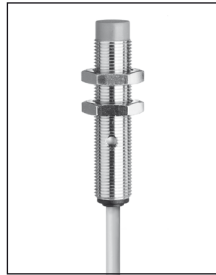

10 mm	10 mm	10 mm	10 mm	5 mm	5 mm
30x30x1 mm	30x30x1 mm	30x30x1 mm	30x30x1 mm	18x18x1 mm	18x18x1 mm
10...30VDC	10...30VDC	10...30VDC	10...30VDC	10...30VDC	10...30VDC
200 mA	200 mA	200 mA	200 mA	200 mA	200 mA
< 10 mA	< 10 mA	< 10 mA	< 10 mA	< 10 mA	< 10 mA
< 2,0 V	< 2,0 V	< 2,0 V	< 2,0 V	< 2,0 V	< 2,0 V
400 Hz	400 Hz	400 Hz	400 Hz	2.000 Hz	2.000 Hz
5 %	5 %	5 %	5 %	10 %	10 %
-25...+70°C	-25...+70°C	-25...+70°C	-25...+70°C	-25...+70°C	-25...+70°C
500 V	500 V	500 V	500 V	500 V	500 V
IP 67	IP 67	IP 67	IP 67	IP 67	IP 67
Ms	Ms	Ms	Ms	Ms	Ms
2.0m, PVC	2.0m, PVC	-	-	2.0m, PVC	2.0m, PVC

DCCK 12 M 10 PSLK	DCC 12 M 10 PSLK	DCCK 12 M 10 PSK-IBSL	DCC 12 M 10 PSK-IBSL	DCCK 18 M 05 PSLK	DCC 18 M 05 PSLK
DCCK 12 M 10 POLK	DCC 12 M 10 POLK	DCCK 12 M 10 POK-IBSL	DCC 12 M 10 POK-IBSL	DCCK 18 M 05 POLK	DCC 18 M 05 POLK
-	-	-	-	-	-
-	-	-	-	-	-
-	-	-	-	-	-
-	-	-	-	-	-
-	-	-	-	-	-
-	-	VK... (Schließer / NO)	VK... (Schließer / NO)	-	-
-	-	VK.../4 (Öffner / NC)	VK.../4 (Öffner / NC)	-	-

Induktive Näherungsschalter | Inductive proximity switches

b 5 mm



b 5 mm

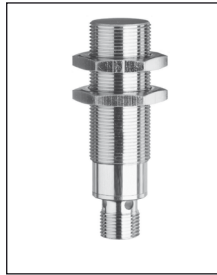

nb 8 mm



nb 8 mm

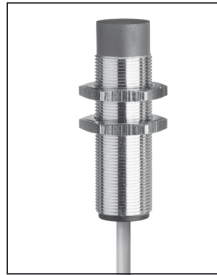

nb 8 mm



nb 8 mm

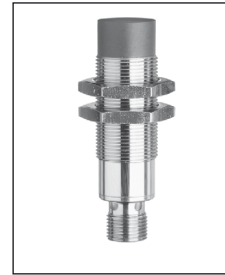

M18x1
Einbauhinweise siehe Seite 85 ①
Installation notes see page 85 ①

mm (typ.)

M18x1
Einbauhinweise siehe Seite 85 ①
Installation notes see page 85 ①

mm (typ.)

M18x1
Einbauhinweise siehe Seite 85 ①
Installation notes see page 85 ①

mm (typ.)

M18x1
Einbauhinweise siehe Seite 85 ①
Installation notes see page 85 ①

mm (typ.)

M18x1
Einbauhinweise siehe Seite 85 ①
Installation notes see page 85 ①

mm (typ.)

M18x1
Einbauhinweise siehe Seite 85 ①
Installation notes see page 85 ①

mm (typ.)

5 mm	5 mm	8 mm	8 mm	8 mm	8 mm
18x18x1 mm	18x18x1 mm	24x24x1 mm	24x24x1 mm	24x24x1 mm	24x24x1 mm
10 ... 30VDC	10 ... 30VDC	10 ... 30VDC	10 ... 30VDC	10 ... 30VDC	10 ... 30VDC
200 mA	200 mA	200 mA	200 mA	200 mA	200 mA
< 10 mA	< 10 mA	< 10 mA	< 10 mA	< 10 mA	< 10 mA
< 2,0 V	< 2,0 V	< 2,0 V	< 2,0 V	< 2,0 V	< 2,0 V
2.000 Hz	2.000 Hz	2.000 Hz	2.000 Hz	2.000 Hz	2.000 Hz
10 %	10 %	10 %	10 %	10 %	10 %
-25 ... +70 °C	-25 ... +70 °C	-25 ... +70 °C	-25 ... +70 °C	-25 ... +70 °C	-25 ... +70 °C
500 V	500 V	500 V	500 V	500 V	500 V
IP 67	IP 67	IP 67	IP 67	IP 67	IP 67
Ms	Ms	Ms	Ms	Ms	Ms
-	-	2.0 m, PVC	2.0 m, PVC	-	-

DCCK 18 M 05 PSK-IBSL	DCC 18 M 05 PSK-IBSL	DCCK 18 M 08 PSLK	DCC 18 M 08 PSLK	DCCK 18 M 08 PSK-IBSL	DCC 18 M 08 PSK-IBSL
DCCK 18 M 05 POK-IBSL	DCC 18 M 05 POK-IBSL	DCCK 18 M 08 POLK	DCC 18 M 08 POLK	DCCK 18 M 08 POK-IBSL	DCC 18 M 08 POK-IBSL
-	-	-	-	-	-
-	-	-	-	-	-
-	-	-	-	-	-
-	-	-	-	-	-
-	-	-	-	-	-

VK... (Schließer / NO)	VK... (Schließer / NO)	-	-	VK... (Schließer / NO)	VK... (Schließer / NO)
VK.../4 (Öffner / NC)	VK.../4 (Öffner / NC)	-	-	VK.../4 (Öffner / NC)	VK.../4 (Öffner / NC)

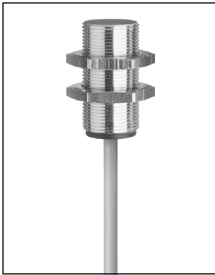
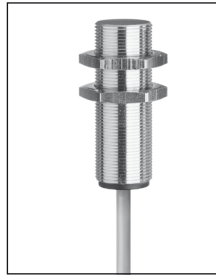
qb 8 mm

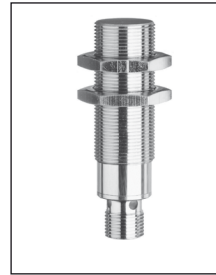
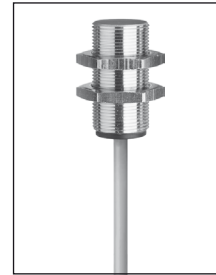
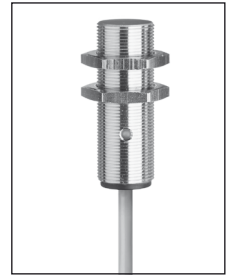
qb 8 mm

qb 8 mm

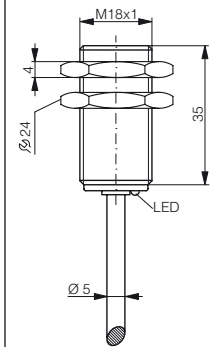
qb 8 mm

qb 12 mm

qb 12 mm

M18x1
Einbauhinweise
siehe Seite 89 ③
Installation notes
see page 89 ③

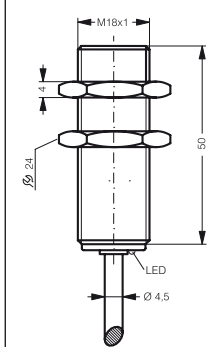

mm (typ.)

M18x1
Einbauhinweise
siehe Seite 89 ③
Installation notes
see page 89 ③



mm (typ.)

M18x1
Einbauhinweise
siehe Seite 89 ③
Installation notes
see page 89 ③

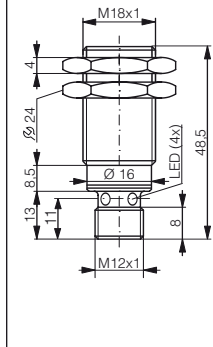

mm (typ.)

M18x1
Einbauhinweise
siehe Seite 89 ③
Installation notes
see page 89 ③

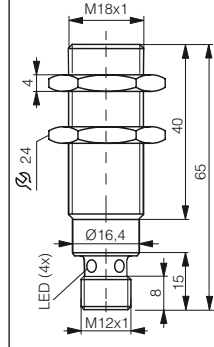

mm (typ.)

M18x1
Einbauhinweise
siehe Seite 87 ②
Installation notes
see page 87 ②

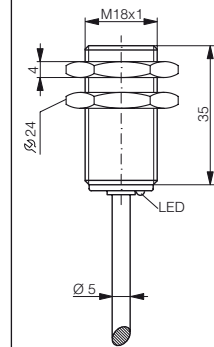

mm (typ.)

M18x1
Einbauhinweise
siehe Seite 87 ②
Installation notes
see page 87 ②

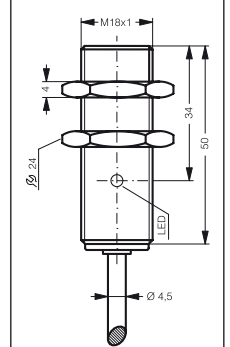

mm (typ.)

8 mm	8 mm	8 mm	8 mm	12 mm	12 mm
24x24x1 mm	24x24x1 mm	24x24x1 mm	24x24x1 mm	36x36x1 mm	36x36x1 mm
10 ... 30VDC	10 ... 30VDC	10 ... 30VDC	10 ... 30VDC	10 ... 30VDC	10 ... 30VDC
200 mA	200 mA	200 mA	200 mA	200 mA	200 mA
< 10 mA	< 10 mA	< 10 mA	< 10 mA	< 10 mA	< 10 mA
< 2,0 V	< 2,0 V	< 2,0 V	< 2,0 V	< 2,0 V	< 2,0 V
1.500 Hz	1.500 Hz	1.500 Hz	1.500 Hz	500 Hz	500 Hz
10 %	10 %	10 %	10 %	5 %	5 %
-25 ... +70 °C	-25 ... +70 °C	-25 ... +70 °C	-25 ... +70 °C	-25 ... +70 °C	-25 ... +70 °C
500 V	500 V	500 V	500 V	500 V	500 V
IP 67	IP 67	IP 67	IP 67	IP 67	IP 67
Ms	Ms	Ms	Ms	Ms	Ms
2.0 m, PVC	2.0 m, PVC	-	-	2.0 m, PVC	2.0 m, PVC

DCCK 18 M 08B PSLK	DCC 18 M 08B PSLK	DCCK 18 M 08B PSK-IBSL	DCC 18 M 08B PSK-IBSL	DCCK 18 M12 PSLK DCCK 18 M12 POLK	DCC 18 M12 PSLK DCC 18 M12 POLK
-	-	-	-	-	-
-	-	-	-	-	-
-	-	-	-	-	-
-	-	-	-	-	-
-	-	-	-	-	-
-	-	-	-	-	-
-	-	VK...	VK...	-	-
-	-	-	-	-	-

Induktive Näherungsschalter | Inductive proximity switches

qb 12 mm

qb 12 mm

nb 20 mm

nb 20 mm

nb 20 mm

nb 20 mm

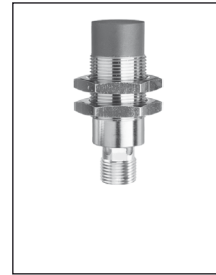
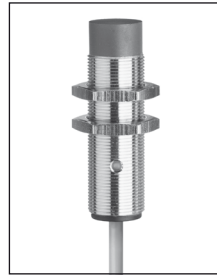
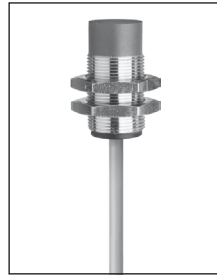

M18x1
Einbauhinweise
siehe Seite 87 ②
Installation notes
see page 87 ②

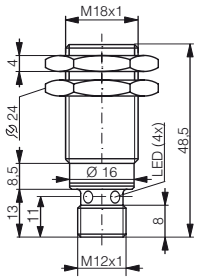

mm (typ.)

M18x1
Einbauhinweise
siehe Seite 87 ②
Installation notes
see page 87 ②

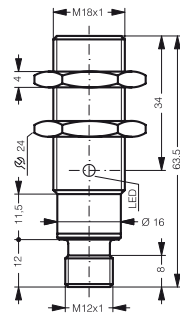

mm (typ.)

M18x1
Einbauhinweise
siehe Seite 87 ②
Installation notes
see page 87 ②

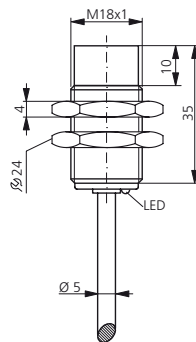

mm (typ.)

M18x1
Einbauhinweise
siehe Seite 87 ②
Installation notes
see page 87 ②

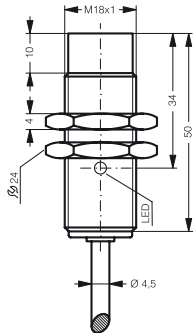

mm (typ.)

M18x1
Einbauhinweise
siehe Seite 87 ②
Installation notes
see page 87 ②

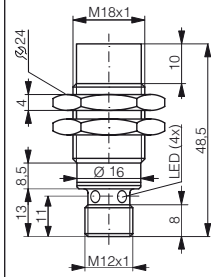

mm (typ.)

M18x1
Einbauhinweise
siehe Seite 87 ②
Installation notes
see page 87 ②

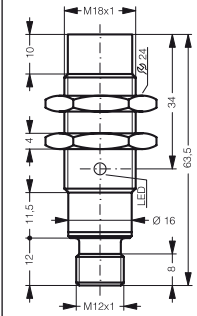

mm (typ.)

12 mm	12 mm	20 mm	20 mm	20 mm	20 mm
36x36x1 mm	36x36x1 mm	60x60x1 mm	60x60x1 mm	60x60x1 mm	60x60x1 mm
10 ... 30VDC	10 ... 30VDC	10 ... 30VDC	10 ... 30VDC	10 ... 30VDC	10 ... 30VDC
200 mA	200 mA	200 mA	200 mA	200 mA	200 mA
< 10 mA	< 10 mA	< 10 mA	< 10 mA	< 10 mA	< 10 mA
< 2,0 V	< 2,0 V	< 2,0 V	< 2,0 V	< 2,0 V	< 2,0 V
500 Hz	500 Hz	200 Hz	200 Hz	200 Hz	200 Hz
5 %	5 %	5 %	5 %	5 %	5 %
-25 ... +70 °C	-25 ... +70 °C	-25 ... +70 °C	-25 ... +70 °C	-25 ... +70 °C	-25 ... +70 °C
500 V	500 V	500 V	500 V	500 V	500 V
IP 67	IP 67	IP 67	IP 67	IP 67	IP 67
Ms	Ms	Ms	Ms	Ms	Ms
-	-	2.0 m, PVC	2.0 m, PVC	-	-

DCCK 18 M12 PSK-IBSL	DCC 18 M12 PSK-IBSL	DCCK 18 M 20 PSLK	DCC 18 M 20 PSLK	DCCK 18 M 20 PSK-IBSL	DCC 18 M 20 PSK-IBSL
DCCK 18 M12 POK-IBSL	DCC 18 M12 POK-IBSL	DCCK 18 M 20 POLK	DCC 18 M 20 POLK	DCCK 18 M 20 POK-IBSL	DCC 18 M 20 POK-IBSL
-	-	-	-	-	-
-	-	-	-	-	-
-	-	-	-	-	-
-	-	-	-	-	-
-	-	-	-	-	-

VK... (Schließer / NO)	VK... (Schließer / NO)	-	-	VK... (Schließer / NO)	VK... (Schließer / NO)
VK.../4 (Öffner / NC)	VK.../4 (Öffner / NC)	-	-	VK.../4 (Öffner / NC)	VK.../4 (Öffner / NC)

b 10 mm

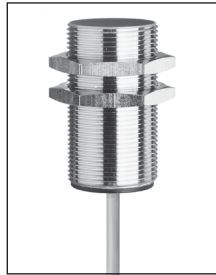
b 10 mm

b 10 mm

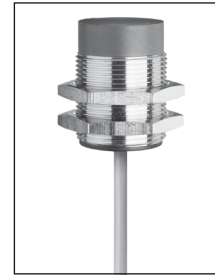
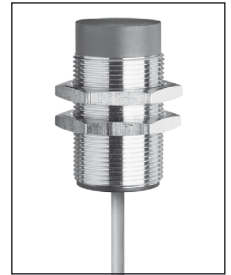
b 10 mm

nb 15 mm

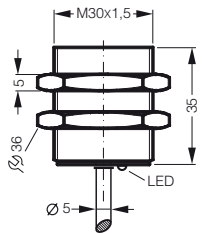
nb 15 mm

M30x1,5
Einbauhinweise
siehe Seite 85 ①
Installation notes
see page 85 ①

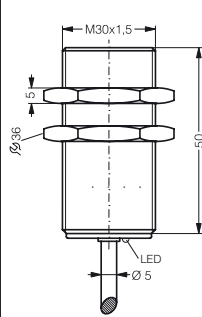

mm (typ.)

M30x1,5
Einbauhinweise
siehe Seite 85 ①
Installation notes
see page 85 ①



mm (typ.)

M30x1,5
Einbauhinweise
siehe Seite 85 ①
Installation notes
see page 85 ①

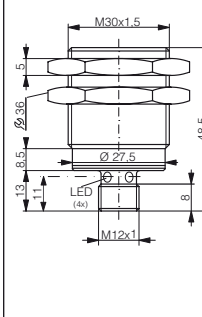

mm (typ.)

M30x1,5
Einbauhinweise
siehe Seite 85 ①
Installation notes
see page 85 ①

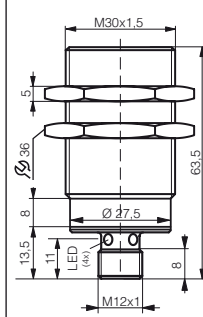

mm (typ.)

M30x1,5
Einbauhinweise
siehe Seite 85 ①
Installation notes
see page 85 ①

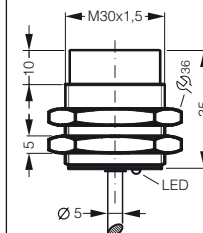

mm (typ.)

M30x1,5
Einbauhinweise
siehe Seite 85 ①
Installation notes
see page 85 ①

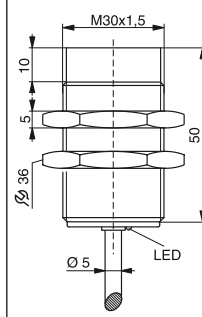

mm (typ.)

10 mm	10 mm	10 mm	10 mm	15 mm	15 mm
30x30x1 mm	30x30x1 mm	30x30x1 mm	30x30x1 mm	45x45x1 mm	45x45x1 mm
10...30VDC	10...30VDC	10...30VDC	10...30VDC	10...30VDC	10...30VDC
200 mA	200 mA	200 mA	200 mA	200 mA	200 mA
< 10 mA	< 10 mA	< 10 mA	< 10 mA	< 10 mA	< 10 mA
< 2,0 V	< 2,0 V	< 2,0 V	< 2,0 V	< 2,0 V	< 2,0 V
1.200 Hz	1.200 Hz	1.200 Hz	1.200 Hz	700 Hz	700 Hz
10 %	10 %	10 %	10 %	10 %	10 %
-25 ... +70 °C	-25 ... +70 °C	-25 ... +70 °C	-25 ... +70 °C	-25 ... +70 °C	-25 ... +70 °C
500 V	500 V	500 V	500 V	500 V	500 V
IP 67	IP 67	IP 67	IP 67	IP 67	IP 67
Ms	Ms	Ms	Ms	Ms	Ms
2,0 m, PVC	2,0 m, PVC	-	-	2,0 m, PVC	2,0 m, PVC

DCCK 30 M 10 PSLK	DCC 30 M 10 PSLK	DCCK 30 M 10 PSK-IBSL	DCC 30 M 10 PSK-IBSL	DCCK 30 M 15 PSLK	DCC 30 M 15 PSLK
DCCK 30 M 10 POLK	DCC 30 M 10 POLK	DCCK 30 M 10 POK-IBSL	DCC 30 M 10 POK-IBSL	DCCK 30 M 15 POLK	DCC 30 M 15 POLK
-	-	-	-	-	-
-	-	-	-	-	-
-	-	-	-	-	-
-	-	-	-	-	-
-	-	-	-	-	-
-	-	VK... (Schließer / NO)	VK... (Schließer / NO)	-	-
-	-	VK.../4 (Öffner / NC)	VK.../4 (Öffner / NC)	-	-

Induktive Näherungsschalter | Inductive proximity switches

nb 15 mm

nb 15 mm

qb 22 mm

qb 22 mm

qb 22 mm

qb 22 mm

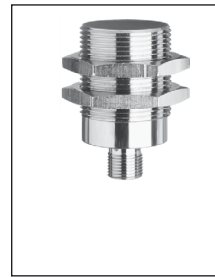
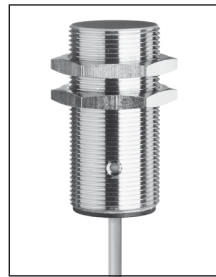
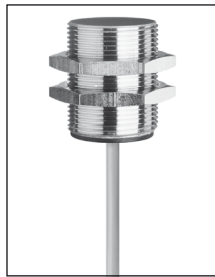
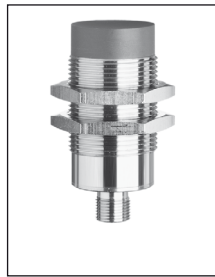

M30x1,5
Einbauhinweise siehe Seite 85 ①
Installation notes see page 85 ①

mm (typ.)

M30x1,5
Einbauhinweise siehe Seite 85 ①
Installation notes see page 85 ①

mm (typ.)

M30x1,5
Einbauhinweise siehe Seite 87 ②
Installation notes see page 87 ②

mm (typ.)

M30x1,5
Einbauhinweise siehe Seite 87 ②
Installation notes see page 87 ②

mm (typ.)

M30x1,5
Einbauhinweise siehe Seite 87 ②
Installation notes see page 87 ②

mm (typ.)

M30x1,5
Einbauhinweise siehe Seite 87 ②
Installation notes see page 87 ②

mm (typ.)

15 mm	15 mm	22 mm	22 mm	22 mm	22 mm
45x45x1 mm	45x45x1 mm	66x66x1 mm	66x66x1 mm	66x66x1 mm	66x66x1 mm
10...30VDC	10...30VDC	10...30VDC	10...30VDC	10...30VDC	10...30VDC
200mA	200mA	200mA	200mA	200mA	200mA
< 10mA	< 10mA	< 10mA	< 10mA	< 10mA	< 10mA
< 2,0 V	< 2,0 V	< 2,0 V	< 2,0 V	< 2,0 V	< 2,0 V
700Hz	700Hz	200Hz	200Hz	200Hz	200Hz
10 %	10 %	5 %	5 %	5 %	5 %
-25...+70°C	-25...+70°C	-25...+70°C	-25...+70°C	-25...+70°C	-25...+70°C
500 V	500 V	500 V	500 V	500 V	500 V
IP 67	IP 67	IP 67	IP 67	IP 67	IP 67
Ms	Ms	Ms	Ms	Ms	Ms
-	-	2.0m, PVC	2.0m, PVC	-	-

DCCK 30 M 15 PSK-IBSL	DCC 30 M 15 PSK-IBSL	DCCK 30 M 22 PSLK	DCC 30 M 22 PSLK	DCCK 30 M 22 PSK-IBSL	DCC 30 M 22 PSK-IBSL
DCCK 30 M 15 POK-IBSL	DCC 30 M 15 POK-IBSL	DCCK 30 M 22 POLK	DCC 30 M 22 POLK	DCCK 30 M 22 POK-IBSL	DCC 30 M 22 POK-IBSL
-	-	-	-	-	-
-	-	-	-	-	-
-	-	-	-	-	-
-	-	-	-	-	-
-	-	-	-	-	-

VK... (Schließer / NO)	VK... (Schließer / NO)	-	-	VK... (Schließer / NO)	VK... (Schließer / NO)
VK.../4 (Öffner / NC)	VK.../4 (Öffner / NC)	-	-	VK.../4 (Öffner / NC)	VK.../4 (Öffner / NC)

nb 40 mm

nb 40 mm

nb 40 mm

nb 40 mm

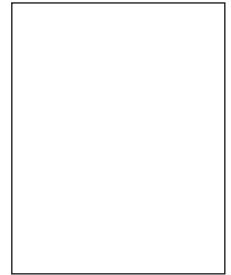
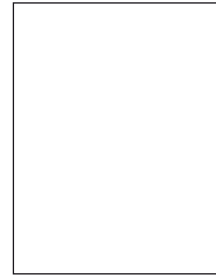
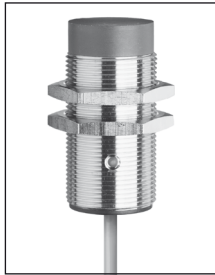

M30x1,5
Einbauhinweise
siehe Seite 87 ②
Installation notes
see page 87 ②

mm (typ.)

M30x1,5
Einbauhinweise
siehe Seite 87 ②
Installation notes
see page 87 ②

mm (typ.)

M30x1,5
Einbauhinweise
siehe Seite 87 ②
Installation notes
see page 87 ②

mm (typ.)

M30x1,5
Einbauhinweise
siehe Seite 87 ②
Installation notes
see page 87 ②

mm (typ.)

mm (typ.)

mm (typ.)

40 mm	40 mm	40 mm	40 mm
120x120x1 mm	120x120x1 mm	120x120x1 mm	120x120x1 mm
10...30VDC	10...30VDC	10...30VDC	10...30VDC
200 mA	200 mA	200 mA	200 mA
< 10 mA	< 10 mA	< 10 mA	< 10 mA
< 2,0 V	< 2,0 V	< 2,0 V	< 2,0 V
100 Hz	100 Hz	100 Hz	100 Hz
5 %	5 %	5 %	5 %
-25...+70°C	-25...+70°C	-25...+70°C	-25...+70°C
500 V	500 V	500 V	500 V
IP 67	IP 67	IP 67	IP 67
Ms	Ms	Ms	Ms
2.0m, PVC	2.0m, PVC	-	-

DCCK 30 M 40 PSLK	DCC 30 M 40 PSLK	DCCK 30 M 40 PSK-IBSL	DCC 30 M 40 PSK-IBSL
DCCK 30 M 40 POLK	DCC 30 M 40 POLK	DCCK 30 M 40 POK-IBSL	DCC 30 M 40 POK-IBSL
-	-	-	-
-	-	-	-
-	-	-	-
-	-	-	-
-	-	-	-
-	-	VK... (Schließer / NO)	VK... (Schließer / NO)
-	-	VK.../4 (Öffner / NC)	VK.../4 (Öffner / NC)

Induktive Näherungsschalter | Inductive proximity switches

b 0,8 mm

b 0,8 mm

b 1,5 mm

b 1,5 mm

b 1,5 mm

b 1,5 mm

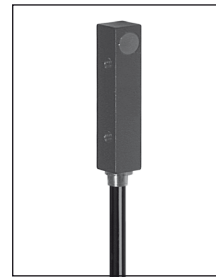

□ 5x5mm
Einbauhinweise siehe Seite 85 ①
Installation notes see page 85 ①

mm (typ.)

□ 5x5mm
Einbauhinweise siehe Seite 85 ①
Installation notes see page 85 ①

mm (typ.)

□ 5x5mm
Einbauhinweise siehe Seite 89 ③
Installation notes see page 89 ③

mm (typ.)

□ 5x5mm
Einbauhinweise siehe Seite 89 ③
Installation notes see page 89 ③

mm (typ.)

□ 8x8mm
Einbauhinweise siehe Seite 90 ④
Installation notes see page 90 ④

mm (typ.)

□ 8x8mm
Einbauhinweise siehe Seite 90 ④
Installation notes see page 90 ④

mm (typ.)

0,8mm	0,8mm	1,5mm	1,5mm	1,5mm	1,5mm
5x5x1 mm	5x5x1 mm	5x5x1 mm	5x5x1 mm	8x8x1 mm	8x8x1 mm
10 ... 30VDC	10 ... 30VDC	10 ... 30VDC	10 ... 30VDC	10 ... 35VDC	10 ... 35VDC
200mA	200mA	200mA	200mA	200mA	200mA
< 10mA	< 10mA	< 10mA	< 10mA	< 6mA	< 6mA
< 2,0 V	< 2,0 V	< 2,0 V	< 2,0 V	< 2,0 V	< 2,0 V
5.000Hz	5.000Hz	3.000Hz	3.000Hz	2.000Hz	2.000Hz
10 %	10 %	10 %	10 %	3 ... 15 %	3 ... 15 %
-25 ... +70°C	-25 ... +70°C	-25 ... +70°C	-25 ... +70°C	-25 ... +70°C	-25 ... +70°C
500 V	500 V	500 V	500 V	500 V	500 V
IP 67	IP 67	IP 67	IP 67	IP 67	IP 67
Ms	Ms	Ms	Ms	Al	Al
2.0m, PUR	0,15 m, PUR	2.0m, PUR	0,15 m, PUR	2.0m, PUR	2.0m, PUR

DCCQ 05 M 0.8 PSLK	DCCQ 05 M 0.8 PSK-K-TSL	DCCQ 05 M 1.5 PSLK	DCCQ 05 M 1.5 PSK-K-TSL	DCQ 08 M 1.5 PSLK	DCQZ 08 M 1.5 PSLK
DCCQ 05 M 0.8 POLK	DCCQ 05 M 0.8 POK-K-TSL	DCCQ 05 M 1.5 POLK	DCCQ 05 M 1.5 POK-K-TSL	DCQ 08 M 1.5 POLK	DCQZ 08 M 1.5 POLK
-	-	-	-	-	-
-	-	-	-	-	-
-	-	-	-	-	-
-	-	-	-	-	-
-	-	-	-	-	-
-	-	-	-	-	-
-	TK...	-	TK...	-	-
-	-	-	-	-	-

b 1,5 mm

b 1,5 mm

b 1,5 mm

b 1,5 mm

b 2 mm

b 2 mm

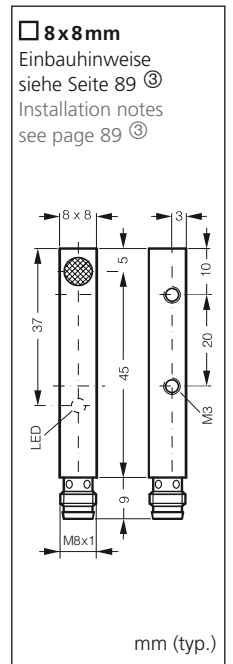
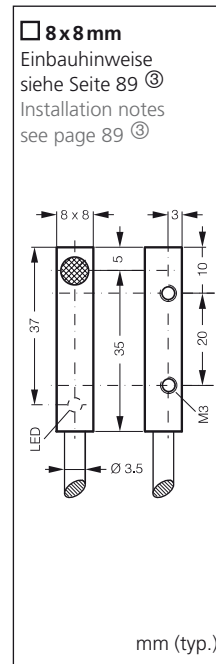
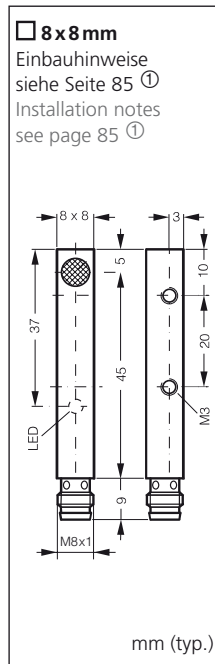
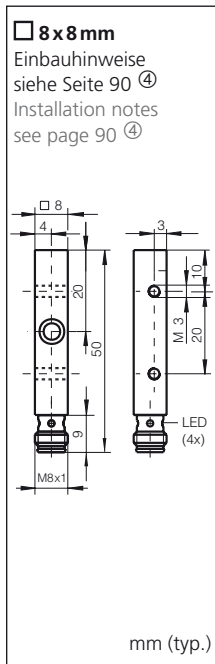
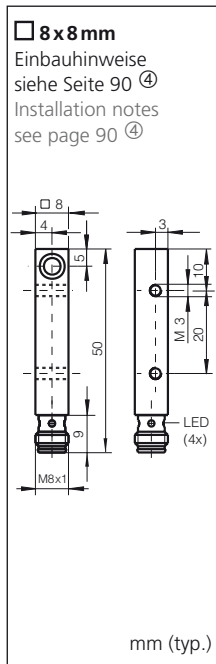
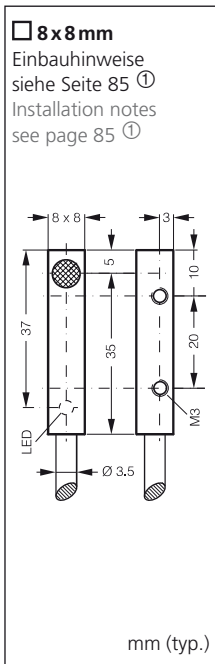
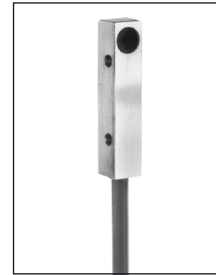

1,5mm	1,5mm	1,5mm	1,5mm	2mm	2mm
8x8x1mm	8x8x1mm	8x8x1mm	8x8x1mm	8x8x1mm	8x8x1mm
10...30VDC	10...35VDC	10...35VDC	10...30VDC	10...30VDC	10...30VDC
200mA	200mA	200mA	200mA	200mA	200mA
< 10mA	< 6mA	< 6mA	< 10mA	< 10mA	< 10mA
< 2,0 V	< 2,0 V	< 2,0 V	< 2,0 V	< 2,0 V	< 2,0 V
5.000Hz	2.000Hz	2.000Hz	5.000Hz	3.000Hz	3.000Hz
10%	3...15%	3...15%	5%	5%	5%
-25...+70°C	-25...+70°C	-25...+70°C	-25...+70°C	-25...+70°C	-25...+70°C
500 V	500 V	500 V	500 V	500 V	500 V
IP 67	IP 67	IP 67	IP 67	IP 67	IP 67
Ms	Al	Al	Ms	Ms	Ms
2.0m, PVC	-	-	-	2.0m, PVC	-

DCCQ 08 M 1.5 PSLK	DCQ 08 M 1.5 PSK-TSL	DCQZ 08 M 1.5 PSK-TSL	DCCQ 08 M 1.5 PSK-TSL	DCCQ 08 M 02 PSLK	DCCQ 08 M 02 PSK-TSL
DCCQ 08 M 1.5 POLK	-	-	DCCQ 08 M 1.5 POK-TSL	DCCQ 08 M 02 POLK	DCCQ 08 M 02 POK-TSL
-	-	-	-	-	-
-	-	-	-	-	-
-	-	-	-	-	-
-	-	-	-	-	-
-	-	-	-	-	-
-	TK...	TK...	TK...	-	TK...
-	-	-	-	-	-

Induktive Näherungsschalter | Inductive proximity switches

qb 3 mm

qb 3 mm

b 2 mm

b 2 mm

b 2 mm

b 2 mm

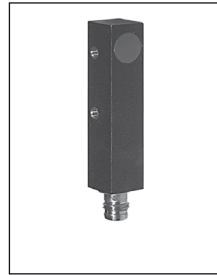
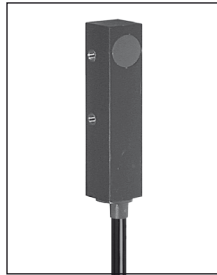

□ 8x8mm
Einbauhinweise
siehe Seite 87 ②
Installation notes
see page 87 ②

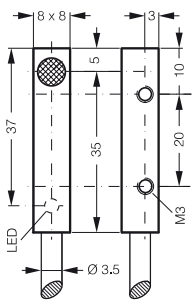

mm (typ.)

□ 8x8mm
Einbauhinweise
siehe Seite 87 ②
Installation notes
see page 87 ②

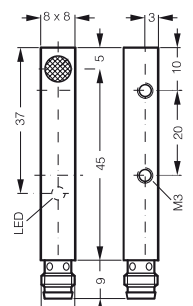

mm (typ.)

□ 12x12mm
Einbauhinweise
siehe Seite 90 ④
Installation notes
see page 90 ④

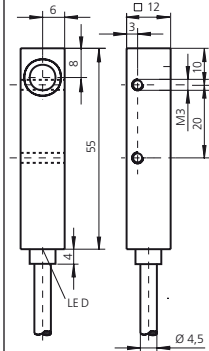

mm (typ.)

□ 12x12mm
Einbauhinweise
siehe Seite 90 ④
Installation notes
see page 90 ④

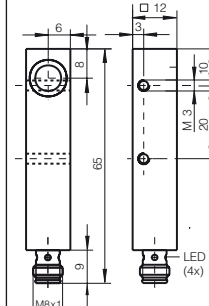

mm (typ.)

28x16x10mm
Einbauhinweise
siehe Seite 90 ④
Installation notes
see page 90 ④

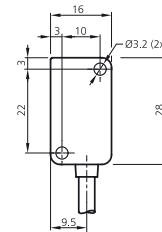

mm (typ.)

28x16x10mm
Einbauhinweise
siehe Seite 90 ④
Installation notes
see page 90 ④

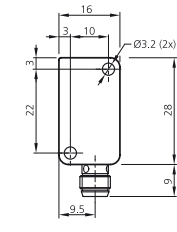

mm (typ.)

3mm	3mm	2mm	2mm	2mm	2mm
9x9x1 mm	9x9x1 mm	12x12x1 mm	12x12x1 mm	10x10x1 mm	10x10x1 mm
10...30VDC	10...30VDC	10...35VDC	10...35VDC	10...35VDC	10...35VDC
200mA	200mA	200mA	200mA	200mA	200mA
< 10mA	< 10mA	< 6mA	< 6mA	< 16mA	< 16mA
< 2,0 V	< 2,0 V	< 2,0 V	< 2,0 V	< 2,0 V	< 2,0 V
1.000Hz	1.000Hz	2.000Hz	2.000Hz	2.000Hz	2.000Hz
5%	5%	3...15%	3...15%	3...15%	3...15%
-25...+70°C	-25...+70°C	-25...+70°C	-25...+70°C	-25...+70°C	-25...+70°C
500 V	500 V	500 V	500 V	500 V	500 V
IP 67	IP 67	IP 67	IP 67	IP 67	IP 67
Ms	Ms	Al	Al	Ks	Ks
2.0m, PVC	-	2.0m, PUR	-	2.0m, PUR	-

DCCQ 08 M 03 PSLK	DCCQ 08 M 03 PSK-TSL	DCQ 12 M 02 PSLK	DCQ 12 M 02 PSK-TSL	DCR 30 K 02 PSLK	DCR 30 K 02 PSK-TSL
DCCQ 08 M 03 POLK	DCCQ 08 M 03 POK-TSL	DCQ 12 M 02 POLK	DCQ 12 M 02 POK-TSL	DCR 30 K 02 POLK	DCR 30 K 02 POK-TSL
-	-	-	-	-	-
-	-	-	-	-	-
-	-	-	-	-	-
-	-	-	-	-	-
-	-	-	-	-	-
-	-	-	-	-	-
-	TK...	-	TK...	-	TK...
-	-	-	-	-	-

b 1,5 mm

b 2 mm

b 2 mm

nb 4 mm

nb 4 mm

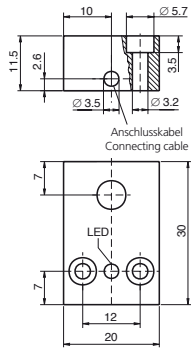

30 x 20 x 11,5 mm
Einbauhinweise
siehe Seite 90 ④
Installation notes
see page 90 ④

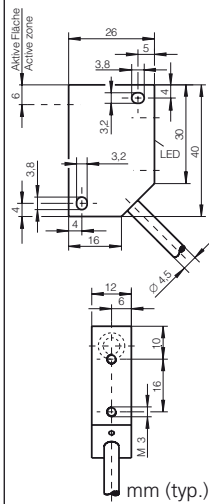

40 x 26 x 12 mm
Einbauhinweise
siehe Seite 90 ④
Installation notes
see page 90 ④

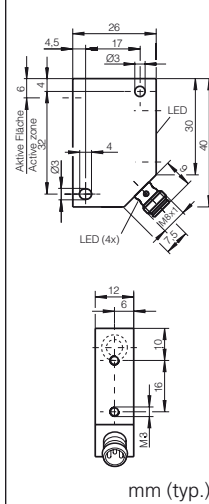

40 x 26 x 12 mm
Einbauhinweise
siehe Seite 90 ④
Installation notes
see page 90 ④



40 x 26 x 12 mm
Einbauhinweise
siehe Seite 90 ④
Installation notes
see page 90 ④

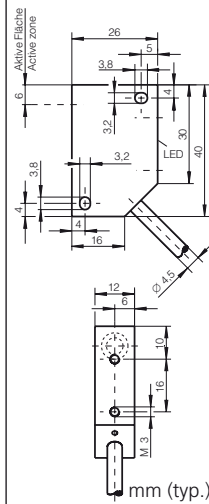

40 x 26 x 12 mm
Einbauhinweise
siehe Seite 90 ④
Installation notes
see page 90 ④

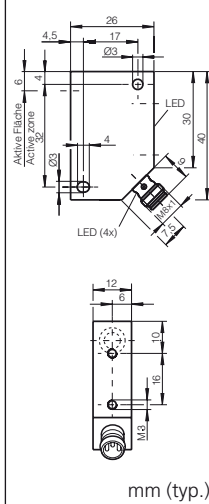

1,5 mm	2 mm	2 mm	4 mm	4 mm
10 x 10 x 1 mm	10 x 10 x 1 mm	10 x 10 x 1 mm	10 x 10 x 1 mm	10 x 10 x 1 mm
10 ... 35 VDC	10 ... 35 VDC	10 ... 35 VDC	10 ... 35 VDC	10 ... 35 VDC
200 mA	200 mA	200 mA	200 mA	200 mA
< 6 mA	< 6 mA	< 6 mA	< 6 mA	< 6 mA
< 2,0 V	< 2,0 V	< 2,0 V	< 2,0 V	< 2,0 V
3.000 Hz	2.000 Hz	2.000 Hz	2.000 Hz	2.000 Hz
3 ... 15 %	3 ... 15 %	3 ... 15 %	3 ... 15 %	3 ... 15 %
-25 ... +70 °C	-25 ... +70 °C	-25 ... +70 °C	-25 ... +70 °C	-25 ... +70 °C
500 V	500 V	500 V	500 V	500 V
IP 67	IP 67	IP 67	IP 67	IP 67
Al	Ks	Ks	Ks	Ks
0,3 m, PUR	2,0 m, PUR	–	2,0 m, PUR	–

DCR 20 M 1.5 PSK-K-TSL	DCR 40 K 02 PSLK	DCR 40 K 02 PSK-TSL	DCR 40 K 04 PSLK	DCR 40 K 04 PSK-TSL
–	DCR 40 K 02 POLK	DCR 40 K 02 POK-TSL	DCR 40 K 04 POLK	DCR 40 K 04 POK-TSL
–	–	–	–	–
–	–	–	–	–
–	–	–	–	–
–	–	–	–	–
–	–	–	–	–
–	–	–	–	–
TK...	–	TK...	–	TK...
–	–	–	–	–

Induktive Näherungsschalter | Inductive proximity switches

b 20 mm



nb 40 mm



b 20 mm



67 x 40 x 40 mm

Einbauhinweise
siehe Seite 85 ①
Installation notes
see page 85 ①

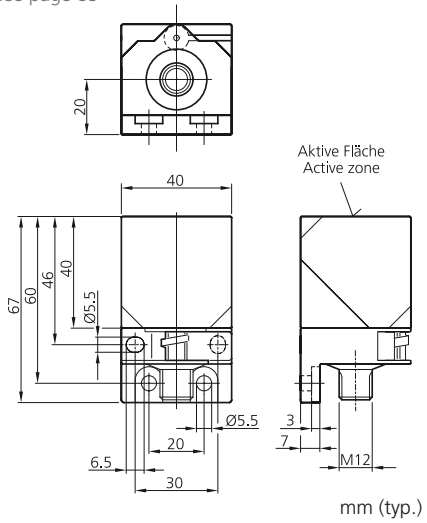

67 x 40 x 40 mm

Einbauhinweise
siehe Seite 85 ①
Installation notes
see page 85 ①

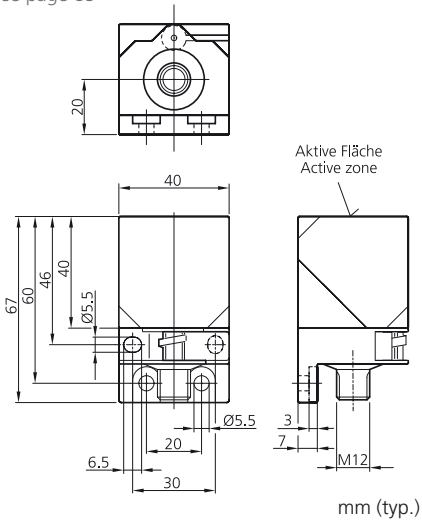

118 x 40 x 40 mm

Einbauhinweise
siehe Seite 85 ①
Installation notes
see page 85 ①

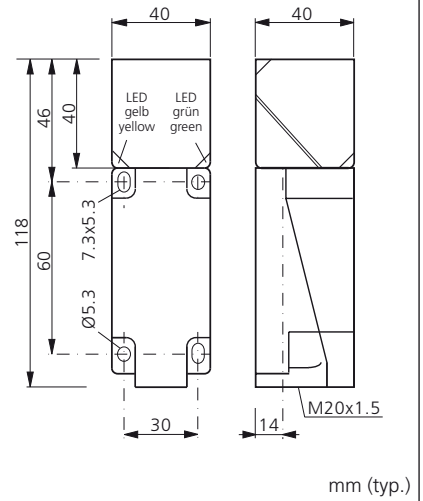

20 mm
60x60x1 mm
10 ... 30VDC
200 mA
< 20 mA
< 2,0 V
150 Hz
5 %
-25 ... +85 °C
4000 V
IP 69K
PA
-

40 mm
120x120x1 mm
10 ... 30VDC
200 mA
< 20 mA
< 2,0 V
100 Hz
5 %
-25 ... +85 °C
4000 V
IP 69K
PA
-

20 mm
60x60x1 mm
10 ... 30VDC
200 mA
< 20 mA
< 2,0 V
150 Hz
5 %
-25 ... +85 °C
IP 68, IP 69K
PA
-

DCCR 44 K 20 PSOL-IBS

DCCR 44 K 40 PSOL-IBS

DCCR 40 K 20 PSOL-KL

VK.../4

VK.../4

-

nb 40 mm

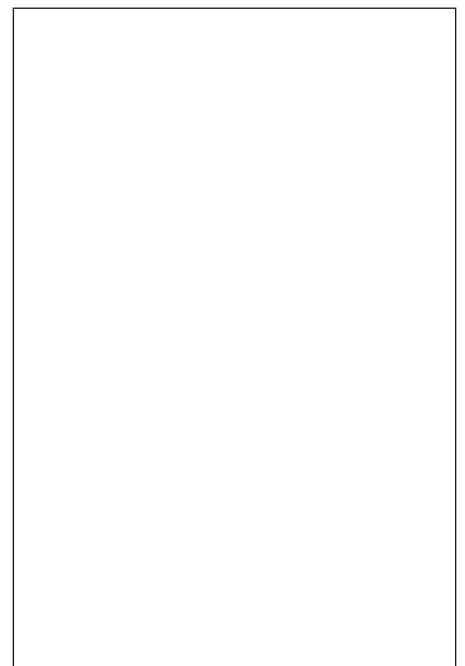
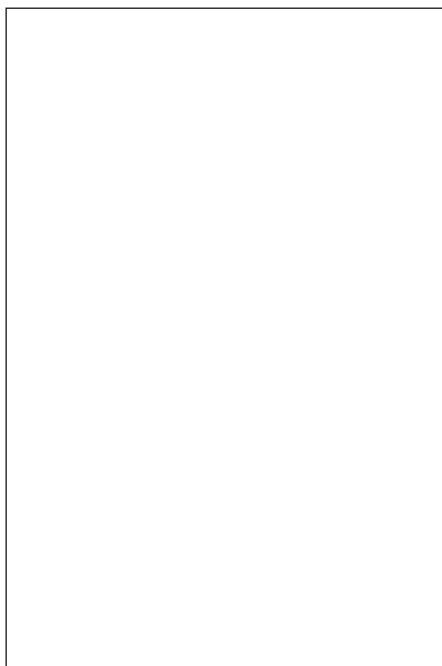
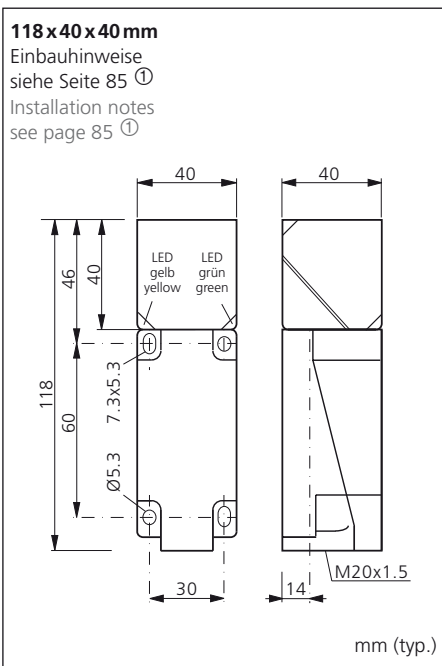

- 40 mm
- 120 x 120 x 1 mm
- 10 ... 30 VDC
- 200 mA
- < 20 mA
- < 2,0 V
- 150 Hz
- 5 %
- 25 ... +85 °C

IP 68, IP 69K
 PA

-

-

DCCR 40 K 40 PSOL-KL

-

-

-

-

-

-

Induktive Näherungsschalter mit geschlossener Ganzstahlhülse

Inductive proximity switches with all stainless steel housing

- 3-facher Normschaltabstand
- Gleicher Schaltabstand auf Stahl und Aluminium
- Gehäuse und aktive Fläche aus Edelstahl
- Unempfindlich gegen aggressive Reinigungsmittel, Umwelteinflüsse und heiße Späne
- 3-times the standard operating distance
- Same operating distance to steel and aluminium
- Housing and sensing face made of stainless steel
- Insensitive to cleaning agents, environmental influences and hot chips

qb 2 mm



Ø 6,5 mm
Druckfest bis 20 bar
 pressure resistant up to 20 bar
 Einbauhinweise siehe Seite 99 ¹⁴
 Installation notes see page 99 ¹⁴

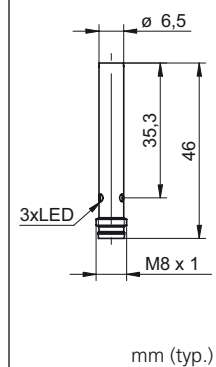

qb 2 mm



M8x1
Druckfest bis 20 bar
 pressure resistant up to 20 bar
 Einbauhinweise siehe Seite 99 ¹⁴
 Installation notes see page 99 ¹⁴

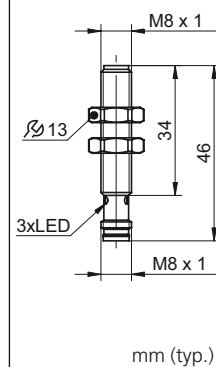

qb 2 mm

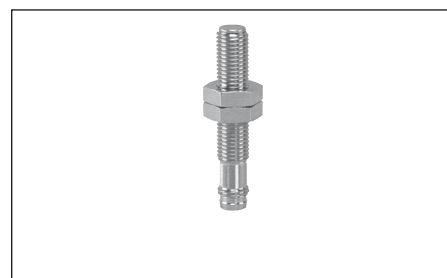

M8x1
Druckfest bis 20 bar/
 pressure resistant up to 20 bar
Schutzart IP 69K
 Protection class IP 69K
Umgebungstemperatur bis 100 °C
 Ambient temperature up to 100 °C
 Einbauhinweise siehe Seite 99 ¹⁴
 Installation notes see page 99 ¹⁴

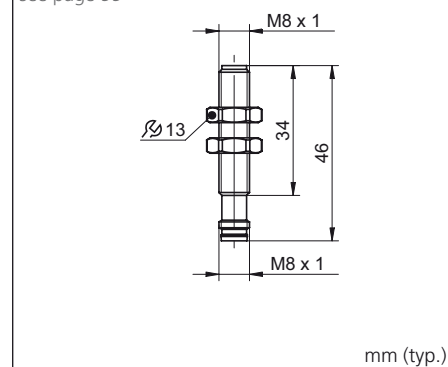

2 mm	2 mm	2 mm
12 x 12 x 1 mm	8 x 8 x 1 mm	8 x 8 x 1 mm
10 ... 30 VDC	10 ... 30 VDC	10 ... 30 VDC
200 mA	200 mA	100 mA
< 20 mA	< 20 mA	< 20 mA
< 2,0 V	< 2,0 V	< 2,0 V
150 Hz	150 Hz	150 Hz
2 ... 20 %	2 ... 20 %	2 ... 20 %
-25 ... +75 °C	-25 ... +75 °C	-25 ... +100 °C
500 V	500 V	500 V
IP 67	IP 67	IP 69K (aktive Fläche / active face)
VA	VA	VA
-	-	-

DCB 6.5 VG 02 PSK-TSL **DCB 08 VG 02 PSK-TSL** **DCB 08 VG 02 PSK-TS/100**
 DCB 6.5 VG 02 POK-TSL DCB 08 VG 02 POK-TSL DCB 08 VG 02 POK-TS/100

-	-	-
-	-	-
-	-	-
-	-	-
-	-	-
-	-	-
TK...	TK...	TK...
-	-	-

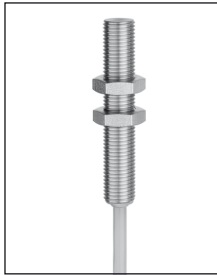
b 3 mm

b 3 mm

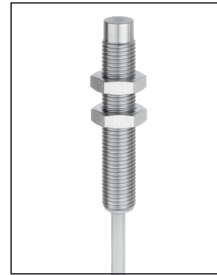
b 3 mm

nb 6 mm

nb 6 mm

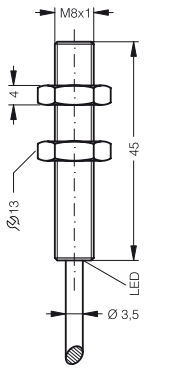
nb 6 mm

M8x1
Druckfest bis 100 bar
 pressure resistant up to 100 bar
 Einbauhinweise siehe Seite 91 ⑤
 Installation notes see page 91 ⑤



mm (typ.)

M8x1
Druckfest bis 100 bar
 pressure resistant up to 100 bar
 Einbauhinweise siehe Seite 91 ⑤
 Installation notes see page 91 ⑤

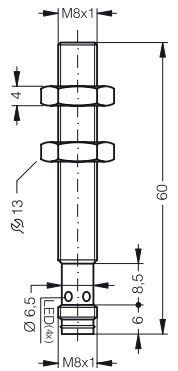

mm (typ.)

M8x1
Druckfest bis 100 bar
 pressure resistant up to 100 bar
 Einbauhinweise siehe Seite 91 ⑤
 Installation notes see page 91 ⑤

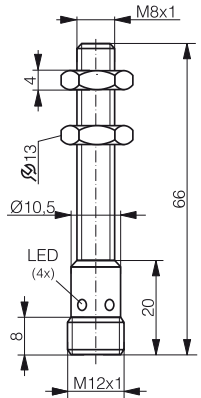

mm (typ.)

M8x1
Druckfest bis 100 bar
 pressure resistant up to 100 bar
 Einbauhinweise siehe Seite 91 ⑤
 Installation notes see page 91 ⑤

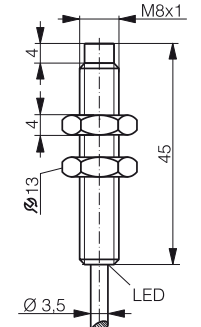

mm (typ.)

M8x1
Druckfest bis 100 bar
 pressure resistant up to 100 bar
 Einbauhinweise siehe Seite 91 ⑤
 Installation notes see page 91 ⑤

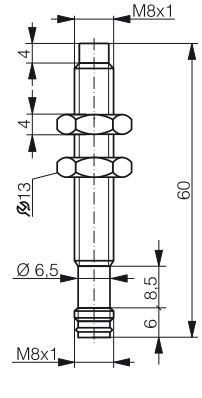

mm (typ.)

M8x1
Druckfest bis 100 bar
 pressure resistant up to 100 bar
 Einbauhinweise siehe Seite 91 ⑤
 Installation notes see page 91 ⑤

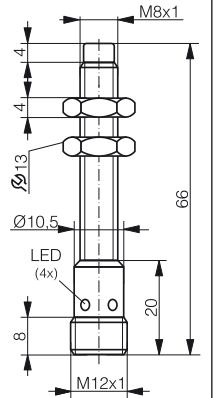

mm (typ.)

3 mm	3 mm	3 mm	6 mm	6 mm	6 mm
9x9x1 mm	9x9x1 mm	9x9x1 mm	18x18x1 mm	18x18x1 mm	18x18x1 mm
10...30VDC	10...30VDC	10...30VDC	10...30VDC	10...30VDC	10...30VDC
200 mA	200 mA	200 mA	200 mA	200 mA	200 mA
< 10 mA	< 10 mA	< 10 mA	< 10 mA	< 10 mA	< 10 mA
< 2,0 V	< 2,0 V	< 2,0 V	< 2,0 V	< 2,0 V	< 2,0 V
1.000 Hz	1.000 Hz	100 Hz	700 Hz	700 Hz	700 Hz
< 15 %	< 15 %	< 15 %	< 15 %	< 15 %	< 15 %
-25...+70°C	-25...+70°C	-25...+70°C	-25...+70°C	-25...+70°C	-25...+70°C
500 V	500 V	500 V	500 V	500 V	500 V
IP 68	IP 67	IP 67	IP 68	IP 67	IP 67
VA	VA	VA	VA	VA	VA
2.0 m, PUR	-	-	2.0 m, PUR	-	-

D7C 08 V 03 PSLK	D7C 08 V 03 PSK-TSL	D7C 08 V 03 PSK-IBSL	D7C 08 V 06 PSLK	D7C 08 V 06 PSK-TSL	D7C 08 V 06 PSK-IBSL
-	-	-	-	-	-
-	-	-	-	-	-
-	-	-	-	-	-
-	-	-	-	-	-
-	-	-	-	-	-
-	-	-	-	-	-
-	-	-	-	-	-
-	TK...	VK...	-	TK...	VK...
-	-	-	-	-	-

Induktive Näherungsschalter mit geschlossener Ganzstahlhülse

Inductive proximity switches with all stainless steel housing

b 2 mm

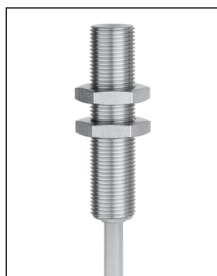

b 2 mm

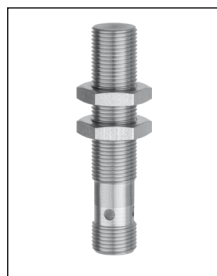

nb 4 mm

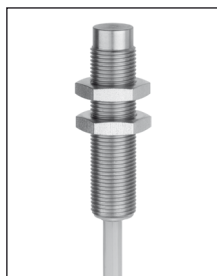

nb 4 mm

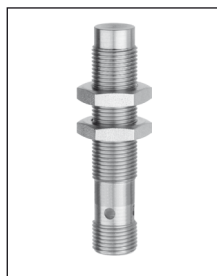

b 6 mm

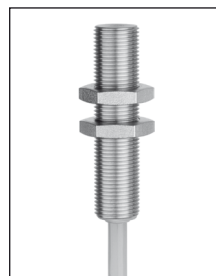

b 6 mm

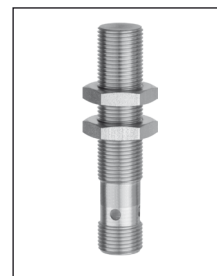

M12x1
Druckfest bis 80 bar
 pressure resistant up to 80 bar
 Einbauhinweise siehe Seite 97 ⑫
 Installation notes see page 97 ⑫

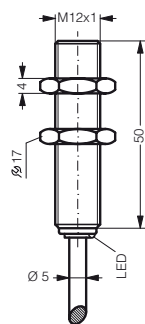

mm (typ.)

M12x1
Druckfest bis 80 bar
 pressure resistant up to 80 bar
 Einbauhinweise siehe Seite 97 ⑫
 Installation notes see page 97 ⑫

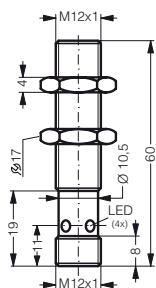

mm (typ.)

M12x1
Druckfest bis 80 bar
 pressure resistant up to 80 bar
 Einbauhinweise siehe Seite 97 ⑫
 Installation notes see page 97 ⑫

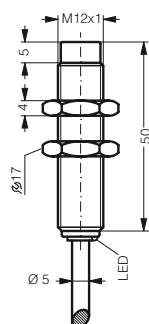

mm (typ.)

M12x1
Druckfest bis 80 bar
 pressure resistant up to 80 bar
 Einbauhinweise siehe Seite 97 ⑫
 Installation notes see page 97 ⑫

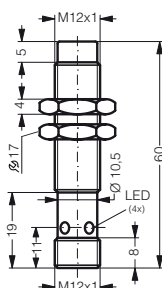

mm (typ.)

M12x1
Druckfest bis 80 bar
 pressure resistant up to 80 bar
 Einbauhinweise siehe Seite 91 ⑤
 Installation notes see page 91 ⑤

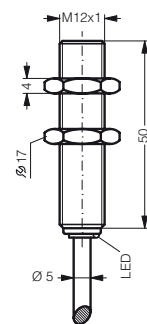

mm (typ.)

M12x1
Druckfest bis 80 bar
 pressure resistant up to 80 bar
 Einbauhinweise siehe Seite 91 ⑤
 Installation notes see page 91 ⑤

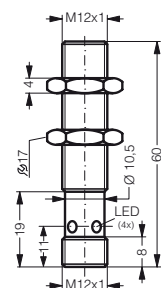

mm (typ.)

2 mm	2 mm	4 mm	4 mm	6 mm	6 mm
12 x 12 x 1 mm	12 x 12 x 1 mm	12 x 12 x 1 mm	12 x 12 x 1 mm	18 x 18 x 1 mm	18 x 18 x 1 mm
10 ... 30 VDC	10 ... 30 VDC	10 ... 30 VDC	10 ... 30 VDC	10 ... 30 VDC	10 ... 30 VDC
200 mA	200 mA	200 mA	200 mA	200 mA	200 mA
< 12 mA	< 12 mA	< 12 mA	< 12 mA	< 12 mA	< 12 mA
< 2,0 V	< 2,0 V	< 2,0 V	< 2,0 V	< 2,0 V	< 2,0 V
350 Hz	350 Hz	250 Hz	250 Hz	600 Hz	600 Hz
< 15 %	< 15 %	< 15 %	< 15 %	< 15 %	< 15 %
-25 ... +70 °C	-25 ... +70 °C	-25 ... +70 °C	-25 ... +70 °C	-25 ... +70 °C	-25 ... +70 °C
500 V	500 V	500 V	500 V	500 V	500 V
IP 69K	IP 68	IP 69K	IP 68	IP 69K	IP 68
VA	VA	VA	VA	VA	VA
2.0 m, PUR	-	2.0 m, PUR	-	2.0 m, PUR	-

D7C 12 V 02 PSLK

D7C 12 V 02 PSK-IBSL

D7C 12 V 04 PSLK

D7C 12 V 04 PSK-IBSL

D7C 12 V 06 PSLK

D7C 12 V 06 PSK-IBSL

-	-	-	-	D7C 12 V 06 POLK	D7C 12 V 06 POK-IBSL
-	-	-	-	-	-
-	-	-	-	-	-
-	-	-	-	-	-
-	-	-	-	-	-
-	-	-	-	-	-
-	-	-	-	-	-

- **VK...**

- **VK...**

- **VK...** (Schließer / NO)

- - **VK.../4** (Öffner / NC)

nb 10 mm



nb 10 mm

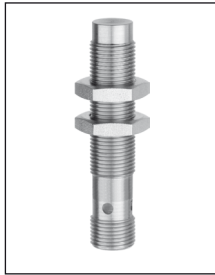

b 5 mm

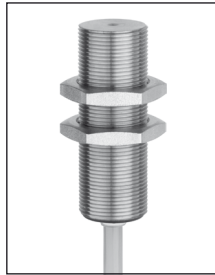

b 5 mm

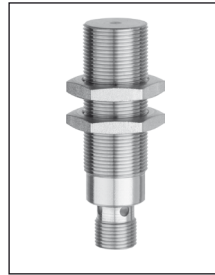

nb 8 mm

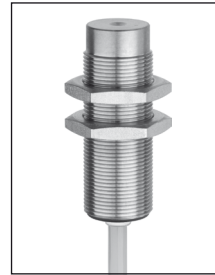

nb 8 mm



M12x1
Druckfest bis 80 bar
 pressure resistant up to 80 bar
 Einbauhinweise siehe Seite 91 ^⑤
 Installation notes see page 91 ^⑤

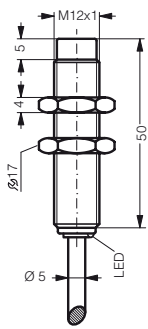

mm (typ.)

M12x1
Druckfest bis 80 bar
 pressure resistant up to 80 bar
 Einbauhinweise siehe Seite 91 ^⑤
 Installation notes see page 91 ^⑤

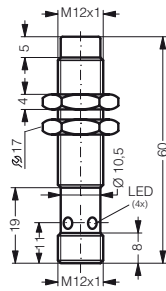

mm (typ.)

M18x1
Druckfest bis 60 bar
 pressure resistant up to 60 bar
 Einbauhinweise siehe Seite 97 ^⑫
 Installation notes see page 97 ^⑫

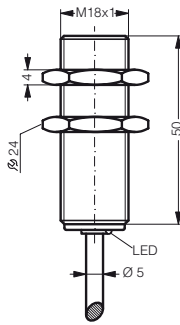

mm (typ.)

M18x1
Druckfest bis 60 bar
 pressure resistant up to 60 bar
 Einbauhinweise siehe Seite 97 ^⑫
 Installation notes see page 97 ^⑫

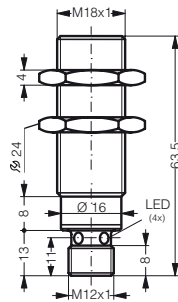

mm (typ.)

M18x1
Druckfest bis 60 bar
 pressure resistant up to 60 bar
 Einbauhinweise siehe Seite 97 ^⑫
 Installation notes see page 97 ^⑫

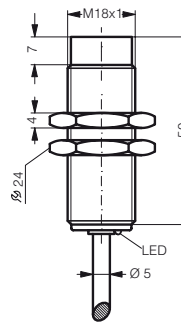

mm (typ.)

M18x1
Druckfest bis 60 bar
 pressure resistant up to 60 bar
 Einbauhinweise siehe Seite 97 ^⑫
 Installation notes see page 97 ^⑫

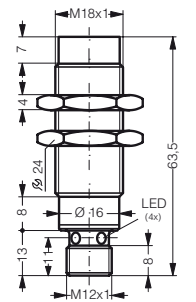

mm (typ.)

10 mm	10 mm	5 mm	5 mm	8 mm	8 mm
30x30x1 mm	30x30x1 mm	18x18x1 mm	18x18x1 mm	24x24x1 mm	24x24x1 mm
10 ... 30VDC	10 ... 30VDC	10 ... 30VDC	10 ... 30VDC	10 ... 30VDC	10 ... 30VDC
200 mA	200 mA	200 mA	200 mA	200 mA	200 mA
< 12 mA	< 12 mA	< 12 mA	< 12 mA	< 12 mA	< 12 mA
< 2,0 V	< 2,0 V	< 2,0 V	< 2,0 V	< 2,0 V	< 2,0 V
400 Hz	400 Hz	200 Hz	200 Hz	250 Hz	250 Hz
< 15 %	< 15 %	< 15 %	< 15 %	< 15 %	< 15 %
-25 ... +70 °C	-25 ... +70 °C	-25 ... +70 °C	-25 ... +70 °C	-25 ... +70 °C	-25 ... +70 °C
500 V	500 V	500 V	500 V	500 V	500 V
IP 69K	IP 68	IP 69K	IP 68	IP 69K	IP 68
VA	VA	VA	VA	VA	VA
2.0m, PUR	-	2.0m, PUR	-	2.0m, PUR	-

D7C 12 V 10 PSLK	D7C 12 V 10 PSK-IBSL	D7C 18 V 05 PSLK	D7C 18 V 05 PSK-IBSL	D7C 18 V 08 PSLK	D7C 18 V 08 PSK-IBSL
D7C 12 V 10 POLK	D7C 12 V 10 POK-IBSL	-	-	-	-
-	-	-	-	-	-
-	-	-	-	-	-
-	-	-	-	-	-
-	-	-	-	-	-
-	-	-	-	-	-
-	VK... (Schließer / NO)	-	VK...	-	VK...
-	VK.../4 (Öffner / NC)	-	-	-	-

Induktive Näherungsschalter mit geschlossener Ganzstahlhülse

Inductive proximity switches with all stainless steel housing

b 10 mm

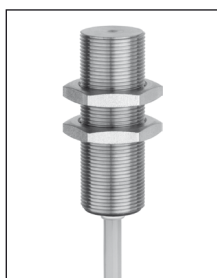

b 10 mm

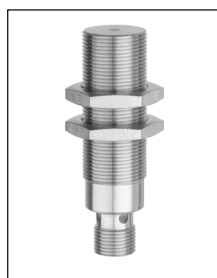

nb 20 mm

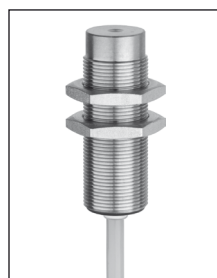

nb 20 mm

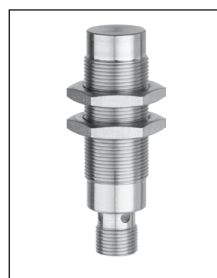

b 10 mm

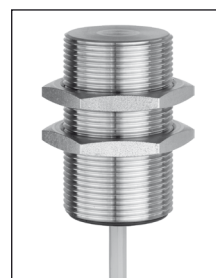

b 10 mm

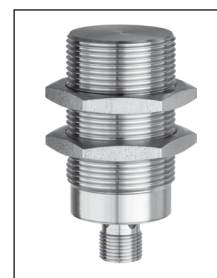

M18x1
Druckfest bis 60 bar
pressure resistant up to 60 bar
Einbauhinweise siehe Seite 91 ⑤
Installation notes see page 91 ⑤

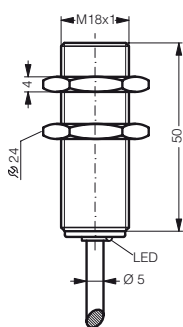

mm (typ.)

M18x1
Druckfest bis 60 bar
pressure resistant up to 60 bar
Einbauhinweise siehe Seite 91 ⑤
Installation notes see page 91 ⑤

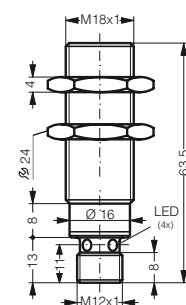

mm (typ.)

M18x1
Druckfest bis 60 bar
pressure resistant up to 60 bar
Einbauhinweise siehe Seite 91 ⑤
Installation notes see page 91 ⑤

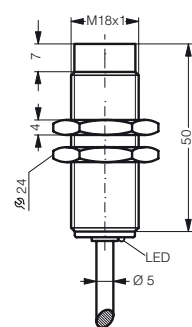

mm (typ.)

M18x1
Druckfest bis 60 bar
pressure resistant up to 60 bar
Einbauhinweise siehe Seite 91 ⑤
Installation notes see page 91 ⑤

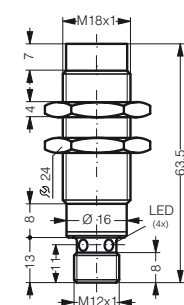

mm (typ.)

M30x1,5
Druckfest bis 40 bar
pressure resistant up to 40 bar
Einbauhinweise siehe Seite 97 ⑫
Installation notes see page 97 ⑫

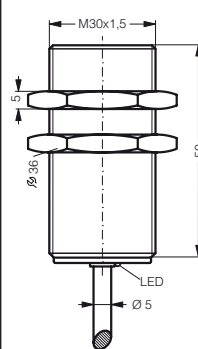

mm (typ.)

M30x1,5
Druckfest bis 40 bar
pressure resistant up to 40 bar
Einbauhinweise siehe Seite 97 ⑫
Installation notes see page 97 ⑫

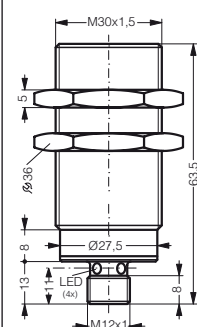

mm (typ.)

10 mm	10 mm	20 mm	20 mm	10 mm	10 mm
30x30x1 mm	30x30x1 mm	60x60x1 mm	60x60x1 mm	30x30x1 mm	30x30x1 mm
10...30VDC	10...30VDC	10...30VDC	10...30VDC	10...30VDC	10...30VDC
200 mA	200 mA	200 mA	200 mA	200 mA	200 mA
< 12 mA	< 12 mA	< 12 mA	< 12 mA	< 12 mA	< 12 mA
< 2,0 V	< 2,0 V	< 2,0 V	< 2,0 V	< 2,0 V	< 2,0 V
200 Hz	200 Hz	200 Hz	200 Hz	75 Hz	75 Hz
< 15 %	< 15 %	< 15 %	< 15 %	< 15 %	< 15 %
-25...+70°C	-25...+70°C	-25...+70°C	-25...+70°C	-25...+70°C	-25...+70°C
500 V	500 V	500 V	500 V	500 V	500 V
IP 69K	IP 68	IP 69K	IP 68	IP 69K	IP 68
VA	VA	VA	VA	VA	VA
2.0 m, PUR	-	2.0 m, PUR	-	2.0 m, PUR	-

D7C 18 V 10 PSLK	D7C 18 V 10 PSK-IBSL	D7C 18 V 20 PSLK	D7C 18 V 20 PSK-IBSL	D7C 30 V 10 PSLK	D7C 30 V 10 PSK-IBSL
D7C 18 V 10 POLK	D7C 18 V 10 POK-IBSL	D7C 18 V 20 POLK	D7C 18 V 20 POK-IBSL	-	-
-	-	-	-	-	-
-	-	-	-	-	-
-	-	-	-	-	-
-	-	-	-	-	-
-	-	-	-	-	-
-	-	-	-	-	-
-	VK... (Schließer / NO)	-	VK... (Schließer / NO)	-	VK...
-	VK.../4 (Öffner / NC)	-	VK.../4 (Öffner / NC)	-	-

nb 15 mm

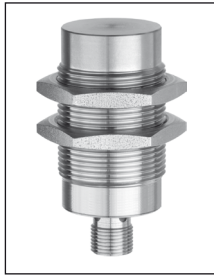
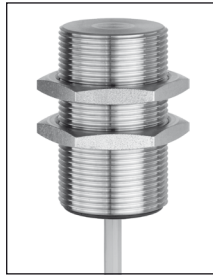
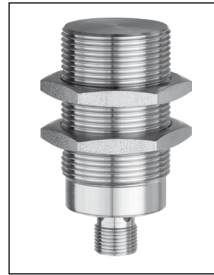
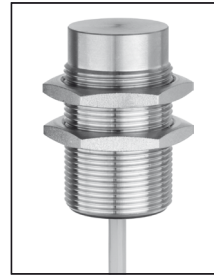
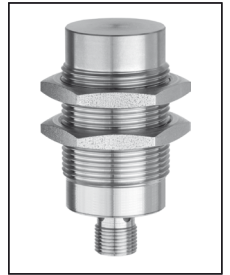
nb 15 mm

b 20 mm

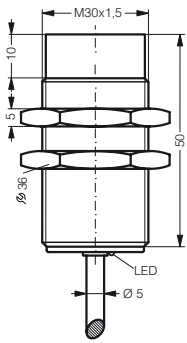
b 20 mm

nb 40 mm

nb 40 mm

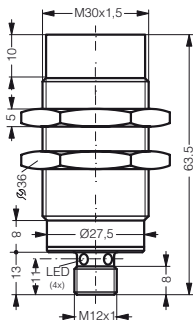
M30 x 1,5
Druckfest bis 40 bar
 pressure resistant up to 40 bar
 Einbauhinweise siehe Seite 97 ⑫
 Installation notes see page 97 ⑫



mm (typ.)

M30 x 1,5
Druckfest bis 40 bar
 pressure resistant up to 40 bar
 Einbauhinweise siehe Seite 97 ⑫
 Installation notes see page 97 ⑫



mm (typ.)

M30 x 1,5
Druckfest bis 40 bar
 pressure resistant up to 40 bar
 Einbauhinweise siehe Seite 91 ⑤
 Installation notes see page 91 ⑤

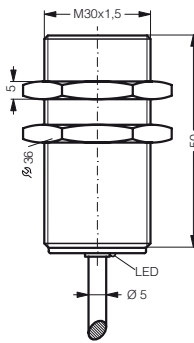

mm (typ.)

M30 x 1,5
Druckfest bis 40 bar
 pressure resistant up to 40 bar
 Einbauhinweise siehe Seite 91 ⑤
 Installation notes see page 91 ⑤

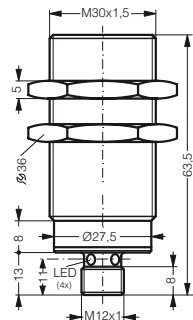

mm (typ.)

M30 x 1,5
Druckfest bis 40 bar
 pressure resistant up to 40 bar
 Einbauhinweise siehe Seite 91 ⑤
 Installation notes see page 91 ⑤

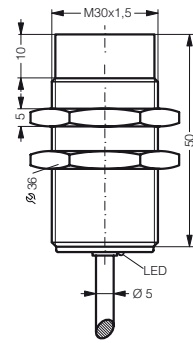

mm (typ.)

M30 x 1,5
Druckfest bis 40 bar
 pressure resistant up to 40 bar
 Einbauhinweise siehe Seite 91 ⑤
 Installation notes see page 91 ⑤

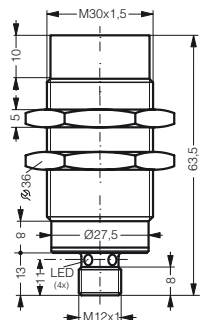

mm (typ.)

15 mm	15 mm	20 mm	20 mm	40 mm	40 mm
45x45x1 mm	45x45x1 mm	60x60x1 mm	60x60x1 mm	120x120x1 mm	120x120x1 mm
10...30VDC	10...30VDC	10...30VDC	10...30VDC	10...30VDC	10...30VDC
200mA	200mA	200mA	200mA	200mA	200mA
< 12 mA	< 12 mA	< 12 mA	< 12 mA	< 12 mA	< 12 mA
< 2,0 V	< 2,0 V	< 2,0 V	< 2,0 V	< 2,0 V	< 2,0 V
75 Hz	75 Hz	100 Hz	100 Hz	90 Hz	90 Hz
< 15 %	< 15 %	< 15 %	< 15 %	< 15 %	< 15 %
-25...+70°C	-25...+70°C	-25...+70°C	-25...+70°C	-25...+70°C	-25...+70°C
500 V	500 V	500 V	500 V	500 V	500 V
IP 69K	IP 68	IP 69K	IP 68	IP 69K	IP 68
VA	VA	VA	VA	VA	VA
2.0m, PUR	-	2.0m, PUR	-	2.0m, PUR	-

D7C 30 V 15 PSLK	D7C 30 V 15 PSK-IBSL	D7C 30 V 20 PSLK	D7C 30 V 20 PSK-IBSL	D7C 30 V 40 PSLK	D7C 30 V 40 PSK-IBSL
-	-	D7C 30 V 20 POLK	D7C 30 V 20 POK-IBSL	D7C 30 V 40 POLK	D7C 30 V 40 POK-IBSL
-	-	-	-	-	-
-	-	-	-	-	-
-	-	-	-	-	-
-	-	-	-	-	-
-	-	-	-	-	-
-	VK...	-	VK... (Schließer / NO)	-	VK... (Schließer / NO)
-	-	-	VK.../4 (Öffner / NC)	-	VK.../4 (Öffner / NC)

Induktive Näherungsschalter in lebensmittelechter und meerwasserfester Ausführung Inductive proximity switches, food-safe and seawater resistant

- Für die Lebensmittelindustrie
- Für Meerwasseranwendungen
- Großer Schaltabstand auf Stahl und Aluminium
- Geschlossene Ganzstahlhülse
- Schutzart IP 68 und IP 69K
- Anschlusskabel aus TPE-S

- For food industry
- For seawater applications
- Large sensing range to steel and aluminium
- All stainless steel housing
- Protection class IP 68 and IP 69K
- Connecting cable made of TPE-S

b 6 mm

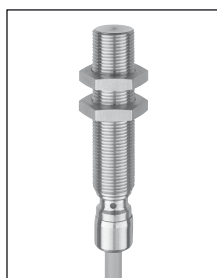

b 6 mm

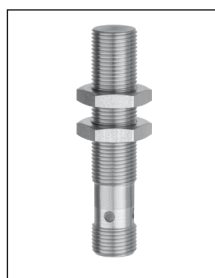

nb 10 mm

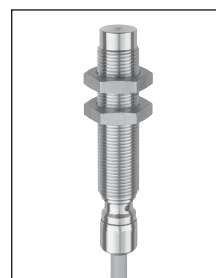

nb 10 mm

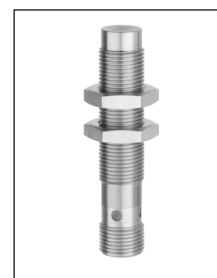

M12x1 / 80 bar
Einbauhinweise
siehe Seite 101 ⁽¹⁶⁾
Installation notes
see page 101 ⁽¹⁶⁾

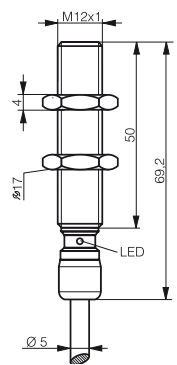

mm (typ.)

M12x1 / 80 bar
Einbauhinweise
siehe Seite 101 ⁽¹⁶⁾
Installation notes
see page 101 ⁽¹⁶⁾

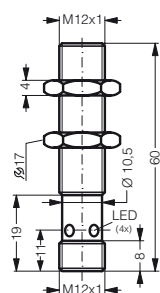

mm (typ.)

M12x1 / 80 bar
Einbauhinweise
siehe Seite 101 ⁽¹⁶⁾
Installation notes
see page 101 ⁽¹⁶⁾

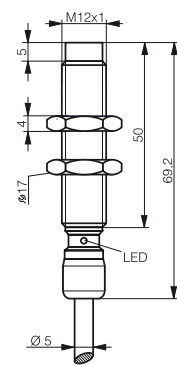

mm (typ.)

M12x1 / 80 bar
Einbauhinweise
siehe Seite 101 ⁽¹⁶⁾
Installation notes
see page 101 ⁽¹⁶⁾

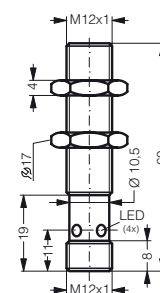

mm (typ.)

6 mm	6 mm	10 mm	10 mm
18x18x1 mm	18x18x1 mm	30x30x1 mm	30x30x1 mm
10 ... 30VDC	10 ... 30VDC	10 ... 30VDC	10 ... 30VDC
200 mA	200 mA	200 mA	200 mA
< 10 mA	< 10 mA	< 10 mA	< 10 mA
< 2,0 V	< 2,0 V	< 2,0 V	< 2,0 V
600 Hz	600 Hz	400 Hz	400 Hz
< 15 %	< 15 %	< 15 %	< 15 %
-25 ... +85 °C	-25 ... +85 °C	-25 ... +85 °C	-25 ... +85 °C
500 V	500 V	500 V	500 V
IP 68 + IP 69K	IP 68 + IP 69K	IP 68 + IP 69K	IP 68 + IP 69K
1.4435	1.4435	1.4435	1.4435
2,0 m, TPE-S	–	2,0 m, TPE-S	–

DCC 12 VL 06 PSLK	DCC 12 VL 06 PSK-IBSL	DCC 12 VL 10 PSLK	DCC 12 VL 10 PSK-IBSL
DCC 12 VL 06 POLK	DCC 12 VL 06 POK-IBSL	DCC 12 VL 10 POLK	DCC 12 VL 10 POK-IBSL
–	–	–	–
–	–	–	–
–	–	–	–
–	–	–	–
–	–	–	–
–	VK... (Schließer / NO)	–	VK... (Schließer / NO)
–	VK.../4 (Öffner / NC)	–	VK.../4 (Öffner / NC)

b 10 mm

b 10 mm

nb 20 mm

nb 20 mm

b 20 mm

b 20 mm

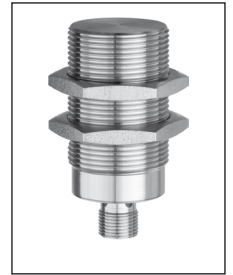
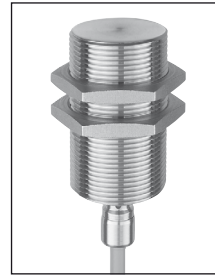
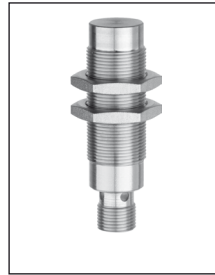
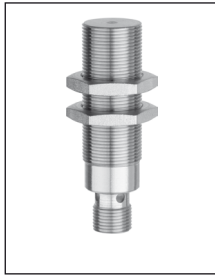
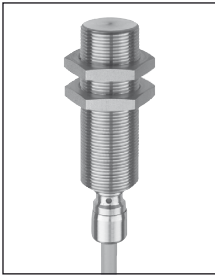

M18x1 / 60 bar
Einbauhinweise
siehe Seite 101 ⁽¹⁶⁾
Installation notes
see page 101 ⁽¹⁶⁾

mm (typ.)

M18x1 / 60 bar
Einbauhinweise
siehe Seite 101 ⁽¹⁶⁾
Installation notes
see page 101 ⁽¹⁶⁾

mm (typ.)

M18x1 / 60 bar
Einbauhinweise
siehe Seite 101 ⁽¹⁶⁾
Installation notes
see page 101 ⁽¹⁶⁾

mm (typ.)

M18x1 / 60 bar
Einbauhinweise
siehe Seite 101 ⁽¹⁶⁾
Installation notes
see page 101 ⁽¹⁶⁾

mm (typ.)

M30x1,5 / 40 bar
Einbauhinweise
siehe Seite 101 ⁽¹⁶⁾
Installation notes
see page 101 ⁽¹⁶⁾

mm (typ.)

M30x1,5 / 40 bar
Einbauhinweise
siehe Seite 101 ⁽¹⁶⁾
Installation notes
see page 101 ⁽¹⁶⁾

mm (typ.)

10 mm	10 mm	20 mm	20 mm	20 mm	20 mm
30x30x1 mm	30x30x1 mm	60x60x1 mm	60x60x1 mm	60x60x1 mm	60x60x1 mm
10 ... 30VDC	10 ... 30VDC	10 ... 30VDC	10 ... 30VDC	10 ... 30VDC	10 ... 30VDC
200 mA	200 mA	200 mA	200 mA	200 mA	200 mA
< 10 mA	< 10 mA	< 10 mA	< 10 mA	< 10 mA	< 10 mA
< 2,0 V	< 2,0 V	< 2,0 V	< 2,0 V	< 2,0 V	< 2,0 V
300 Hz	300 Hz	200 Hz	200 Hz	100 Hz	100 Hz
< 15 %	< 15 %	< 15 %	< 15 %	< 15 %	< 15 %
-25 ... +85 °C	-25 ... +85 °C	-25 ... +85 °C	-25 ... +85 °C	-25 ... +85 °C	-25 ... +85 °C
500 V	500 V	500 V	500 V	500 V	500 V
IP 68 + IP 69K	IP 68 + IP 69K	IP 68 + IP 69K	IP 68 + IP 69K	IP 68 + IP 69K	IP 68 + IP 69K
1.4435	1.4435	1.4435	1.4435	1.4435	1.4435
2,0 m, TPE-S	-	2,0 m, TPE-S	-	2,0 m, TPE-S	-

DCC 18 VL 10 PSLK	DCC 18 VL 10 PSK-IBSL	DCC 18 VL 20 PSLK	DCC 18 VL 20 PSK-IBSL	DCC 30 VL 20 PSLK	DCC 30 VL 20 PSK-IBSL
DCC 18 VL 10 POLK	DCC 18 VL 10 POK-IBSL	DCC 18 VL 20 POLK	DCC 18 VL 20 POK-IBSL	DCC 30 VL 20 POLK	DCC 30 VL 20 POK-IBSL
-	-	-	-	-	-
-	-	-	-	-	-
-	-	-	-	-	-
-	-	-	-	-	-
-	-	-	-	-	-
-	VK... (Schließer / NO)	-	VK... (Schließer / NO)	-	VK... (Schließer / NO)
-	VK.../4 (Öffner / NC)	-	VK.../4 (Öffner / NC)	-	VK.../4 (Öffner / NC)

Induktive Näherungsschalter in lebensmittelechter und meerwasserfester Ausführung Inductive proximity switches, food-safe and seawater resistant

nb 40 mm

nb 40 mm

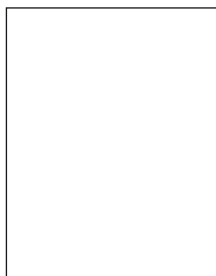

M30x1,5 / 40 bar
Einbauhinweise
siehe Seite 101 ¹⁶
Installation notes
see page 101 ¹⁶

mm (typ.)

M30x1,5 / 40 bar
Einbauhinweise
siehe Seite 101 ¹⁶
Installation notes
see page 101 ¹⁶

mm (typ.)

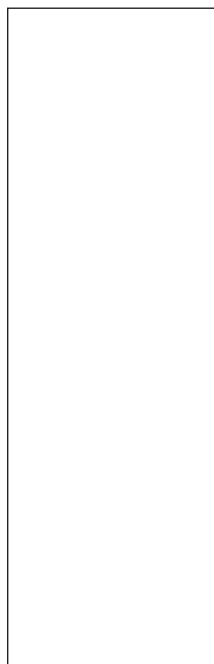
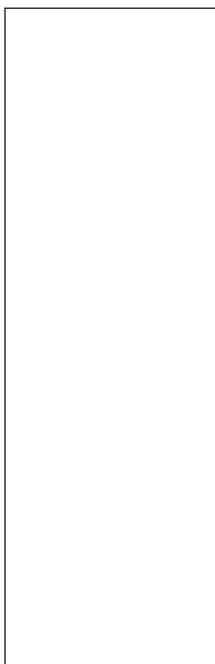

40 mm	40 mm
120x120x1 mm	120x120x1 mm
10...30VDC	10...30VDC
200mA	200mA
< 10mA	< 10mA
< 2,0 V	< 2,0 V
90Hz	90Hz
< 15 %	< 15 %
-25...+85°C	-25...+85°C
500 V	500 V
IP 68 + IP 69K	IP 68 + IP 69K
1.4435	1.4435
2,0 m, TPE-S	-

DCC 30 VL 40 PSLK	DCC 30 VL 40 PSK-IBSL
DCC 30 VL 40 POLK	DCC 30 VL 40 POK-IBSL
-	-
-	-
-	-
-	-
-	-
-	-
-	VK... (Schließer / NO)
-	VK.../4 (Öffner / NC)

A series of horizontal light blue lines spanning the width of the page, intended for taking notes.

Induktive Näherungsschalter, druckfest | Inductive proximity switches, pressure resistant

- Druckfeste Ausführung bis 20 bar
 - Hochdruckfeste Ausführung bis 500 bar
 - Hochtemperaturfeste Ausführung bis 100°C Dauertemperatur
 - Edelstahl-Gehäuse
 - Aktive Fläche Saphir, ZrO₂- oder Edelstahl
-
- Pressure resistant version up to 20 bar
 - High-pressure resistant version up to 500 bar
 - High-temperature resistant version up to 100°C permanent temperature
 - Stainless steel housing
 - Active zone sapphire, ZrO₂- or stainless steel

b 0,6 mm

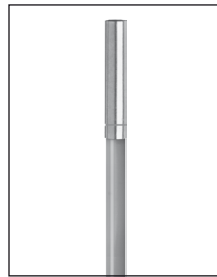

b 0,6 mm



b 2,5 mm

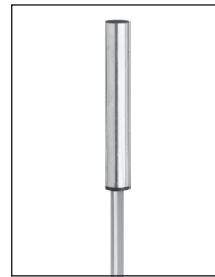

b 2,5 mm



Ø 4 mm
20 bar, IP 68
 Einbauhinweise siehe Seite 92 ⑥
 Installation notes see page 92 ⑥

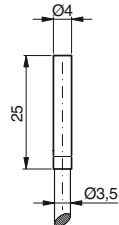

mm (typ.)

M5x0,5
20 bar, IP 68
 Einbauhinweise siehe Seite 92 ⑥
 Installation notes see page 92 ⑥

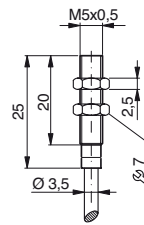

mm (typ.)

Ø 6,5 mm
20 bar, IP 68
 Einbauhinweise siehe Seite 92 ⑥
 Installation notes see page 92 ⑥

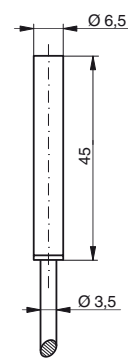

mm (typ.)

M8x1
20 bar, IP 68
 Einbauhinweise siehe Seite 92 ⑥
 Installation notes see page 92 ⑥

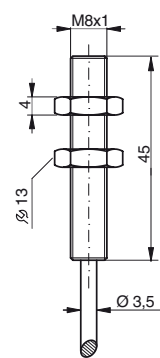

mm (typ.)

0,6 mm	0,6 mm	2,5 mm	2,5 mm
4x4x1 mm	5x5x1 mm	7,5x7,5x1 mm	7,5x7,5x1 mm
10 ... 30VDC	10 ... 30VDC	10 ... 30VDC	10 ... 30VDC
200 mA	200 mA	200 mA	200 mA
< 10 mA	< 10 mA	< 10 mA	< 10 mA
< 2,0 V	< 2,0 V	< 2,0 V	< 2,0 V
5.000 Hz	5.000 Hz	1.000 Hz	1.000 Hz
5 %	5 %	5 %	5 %
-25 ... +70 °C	-25 ... +70 °C	-25 ... +70 °C	-25 ... +70 °C
500 V	500 V	500 V	500 V
IP 68	IP 68	IP 68	IP 68
VA / Saphir	VA / Saphir	VA / ZrO ₂ -Keramik	VA / ZrO ₂ -Keramik
2.0 m, PUR	2.0 m, PUR	2.0 m, PUR	2.0 m, PUR

DCC 4.0 V 0.6 PSLK-E	DCC 05 V 0.6 PSLK-E	DCC 6.5 V 2.5 PSLK-E	DCC 08 V 2.5 PSLK-E
-	-	-	-
-	-	-	-
-	-	-	-
-	-	-	-
-	-	-	-
-	-	-	-
-	-	-	-
-	-	-	-
-	-	-	-
-	-	-	-

b 2,0 mm

b 2,0 mm

b 2,0 mm

b 2,0 mm

M12x1
500 bar, IP 68, IP 69K
 Einbauhinweise
 siehe Seite 93
 Installation notes
 see page 93

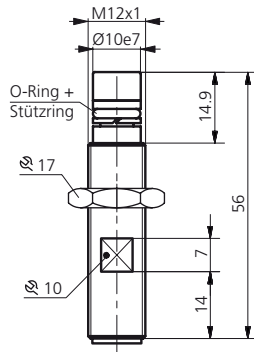

mm (typ.)

M12x1
500 bar, IP 68, IP 69K
 Einbauhinweise
 siehe Seite 93
 Installation notes
 see page 93

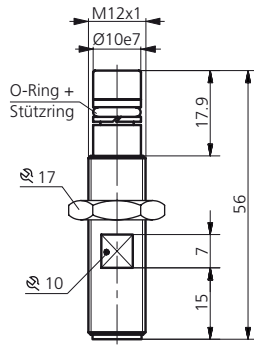

mm (typ.)

M12x1
500 bar, IP 68, IP 69K
 Einbauhinweise
 siehe Seite 93
 Installation notes
 see page 93

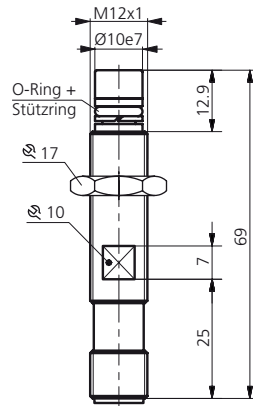

mm (typ.)

M12x1
500 bar, IP 68, IP 69K
 Einbauhinweise
 siehe Seite 93
 Installation notes
 see page 93

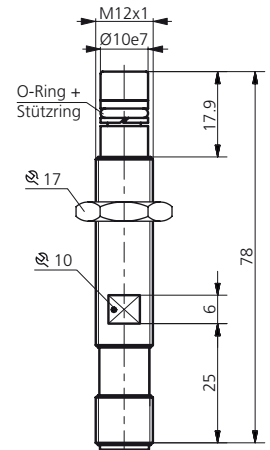

mm (typ.)

2,0mm	2,0mm	2,0mm	2,0mm
10x10x1 mm	10x10x1 mm	10x10x1 mm	10x10x1 mm
10...30VDC	10...30VDC	10...30VDC	10...30VDC
200 mA	200 mA	200 mA	200 mA
< 10 mA	< 10 mA	< 10 mA	< 10 mA
< 2,4 V	< 2,4 V	< 2,4 V	< 2,4 V
400 Hz	400 Hz	400 Hz	400 Hz
15 %	15 %	15 %	15 %
-25...+100°C	-25...+100°C	-25...+100°C	-25...+100°C
500 V	500 V	500 V	500 V
IP 68, IP 69K	IP 68, IP 69K	IP 68, IP 69K	IP 68, IP 69K
V2A	V2A	V2A	V2A
-	-	-	-

DCC 12 VHD 2 PS-B3-56-4	DCC 12 VHD 2 PS-B3-56-7	DCC 12 VHD 2 PS-B3-69-2	DCC 12 VHD 2 PS-B3-78-7
-	-	-	-
-	-	-	-
-	-	-	-
-	-	-	-
-	-	-	-
-	-	-	-
-	-	-	-
VK...	VK...	VK...	VK...
-	-	-	-

Induktive Näherungsschalter, druckfest | Inductive proximity switches, pressure resistant

b 2,0 mm



b 2,0 mm



b 2,0 mm



b 1,5 mm

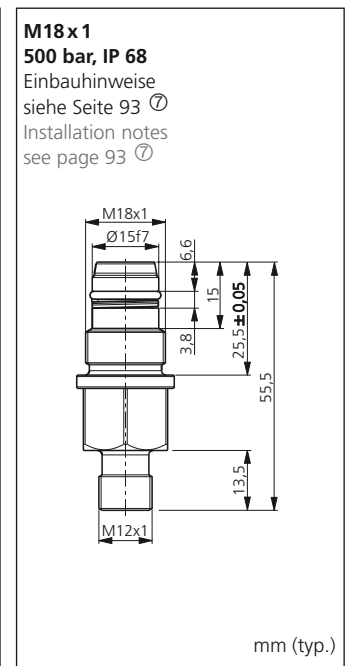
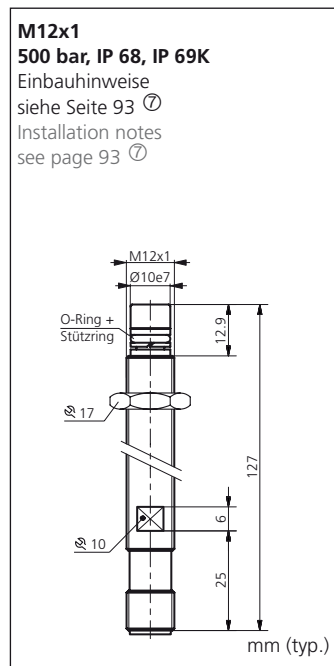
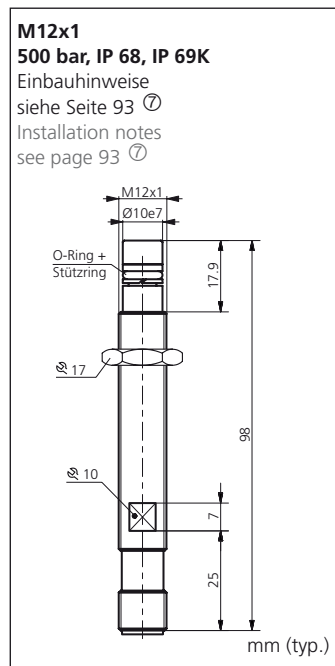
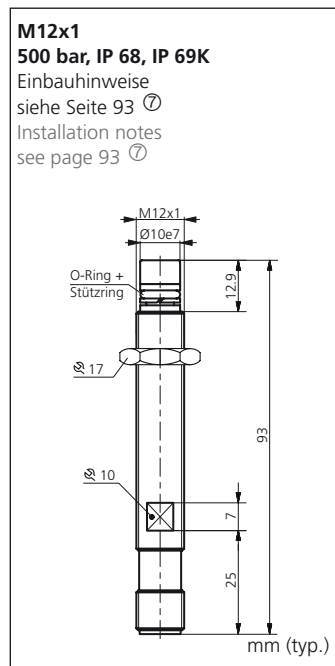

2,0 mm	2,0 mm	2,0 mm	1,5 mm
10x10x1 mm	10x10x1 mm	10x10x1 mm	15x15x1 mm
10 ... 30VDC	10 ... 30VDC	10 ... 30VDC	10 ... 30VDC
200 mA	200 mA	200 mA	200 mA
< 10 mA	< 10 mA	< 10 mA	< 10 mA
< 2,4 V	< 2,4 V	< 2,4 V	< 2,0 V
400 Hz	400 Hz	400 Hz	800 Hz
15 %	15 %	15 %	10 %
-25 ... +100 °C	-25 ... +100 °C	-25 ... +100 °C	-25 ... +80 °C
500 V	500 V	500 V	500 V
IP 68, IP 69K	IP 68, IP 69K	IP 68, IP 69K	IP 68
V2A	V2A	V2A	VA / ZrO ₂ -Keramik
-	-	-	-

DCC 12 VHD 2 PS-B3-93-2	DCC 12 VHD 2 PS-B3-98-7	DCC 12 VHD 2 PS-B3-127-2	DCC 18 V 1.5 PSK-IBSL 500
-	-	-	-
-	-	-	-
-	-	-	-
-	-	-	-
-	-	-	-
-	-	-	-
VK...	VK...	VK...	VK...
-	-	-	-

Induktive Näherungsschalter, hochtemperaturfest

Inductive proximity switches, high-temperature resistant

b 2 mm

nb 4 mm

b 5 mm

nb 7 mm

- Hochtemperaturfeste Ausführung bis 160°C Dauertemperatur
- Klimawechselfeste Ausführung bis 120°C Dauertemperatur und druckfest bis 10 bar
- Edelstahl-Gehäuse
- Aktive Fläche PTFE

- High-temperature resistant version up to 160°C permanent temperature
- Climatic cycle resistant version up to 120°C permanent temperature and pressure resistant up to 10 bar
- Stainless steel housing
- Sensing surface PTFE

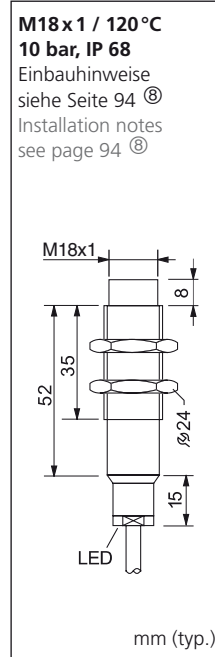
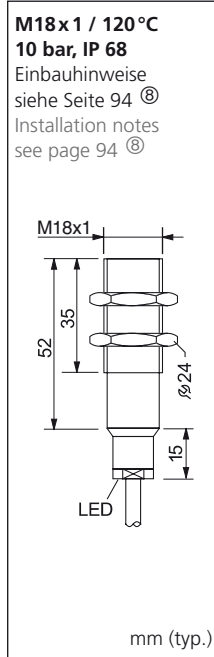
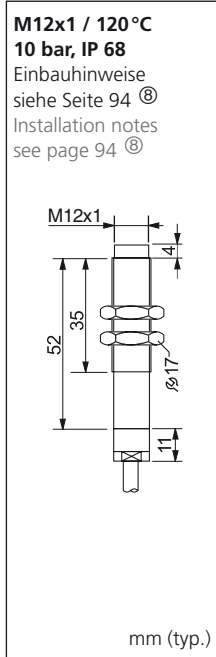
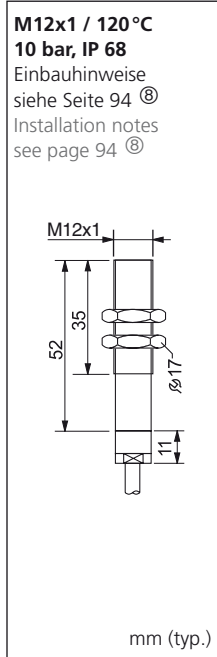
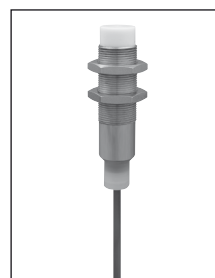
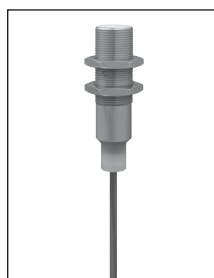
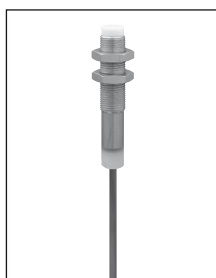
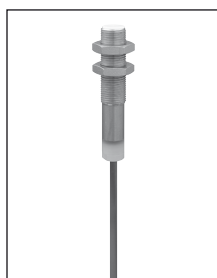

2 mm	4 mm	5 mm	7 mm
12 x 12 x 1 mm	12 x 12 x 1 mm	18 x 18 x 1 mm	21 x 21 x 1 mm
10 ... 33 VDC	10 ... 33 VDC	10 ... 33 VDC	10 ... 33 VDC
200 mA	200 mA	200 mA	200 mA
< 4 mA	< 4 mA	< 4 mA	< 4 mA
< 2,0 V	< 2,0 V	< 2,0 V	< 2,0 V
250 Hz	200 Hz	400 Hz	400 Hz
10 %	10 %	10 %	10 %
-25 ... +120°C	-25 ... +120°C	-25 ... +120°C	-25 ... +120°C
500 V	500 V	500 V	500 V
IP 68	IP 68	IP 68	IP 68
1.4571 / PTFE	1.4571 / PTFE	1.4571 / PTFE	1.4571 / PTFE
2,0 m, PTFE	2,0 m, PTFE	2,0 m, PTFE	2,0 m, PTFE

DCE 12 VH 02 PSK	DCE 12 VH 04 PSK	DCE 18 VH 05 PSLK	DCE 18 VH 07 PSLK
-	-	-	-
-	-	-	-
-	-	-	-
-	-	-	-
-	-	-	-
-	-	-	-
-	-	-	-
-	-	-	-
-	-	-	-
-	-	-	-
-	-	-	-

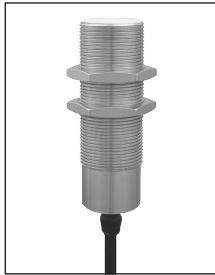
b 5 mm
b 10 mm

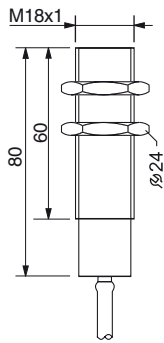
**M18x1 / 160°C
IP 65**

 Einbauhinweise
siehe Seite 94 [®]
Installation notes
see page 94 [®]

mm (typ.)

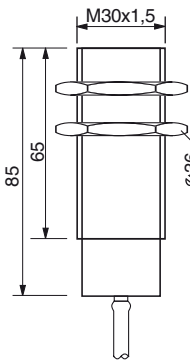
**M30x1,5 / 160°C
IP 65**

 Einbauhinweise
siehe Seite 94 [®]
Installation notes
see page 94 [®]

mm (typ.)

**Diagramme Strombelastbarkeit
in Abhängigkeit von der Umgebungstemperatur**
Diagrams maximum rating
depending on the ambient temperature

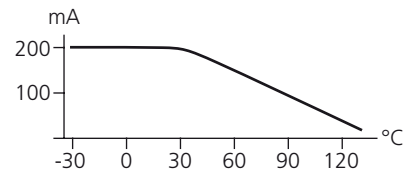
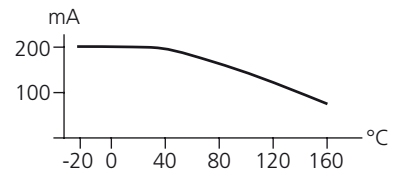
**DCE 12 VH 02 PSK
DCE 12 VH 04 PSK
DCE 18 VH 05 PSLK
DCE 18 VH 07 PSLK**

**DCE 18 VH 05 PSK
DCE 30 VH 10 PSK**

5 mm	10 mm
18x18x1 mm	30x30x1 mm
10...33VDC	10...33VDC
200 mA	200 mA
< 7 mA	< 7 mA
< 2,0 V	< 2,0 V
200 Hz	200 Hz
15 %	15 %
-25...+160°C	-25...+160°C
500 V	500 V
IP 65	IP 65
1.4571 / PTFE	1.4571 / PTFE
2,0 m, PTFE	2,0 m, PTFE

DCE 18 VH 05 PSK	DCE 30 VH 10 PSK
-	-
-	-
-	-
-	-
-	-
-	-
-	-
-	-
-	-
-	-

Induktive Näherungsschalter, hochtemperaturfest Inductive proximity switches, high-temperature resistant

- Hochtemperaturfeste Ausführung bis 230 °C Dauertemperatur (mit externem Verstärker)
- Edelstahl-Gehäuse
- Aktive Fläche LCP
- Kabelmaterial PTFE

- High temperature resistant versions up to 230 °C permanent temperature (with external amplifier)
- Stainless steel housing
- Active zone LCP
- Cable material PTFE

b 2 mm

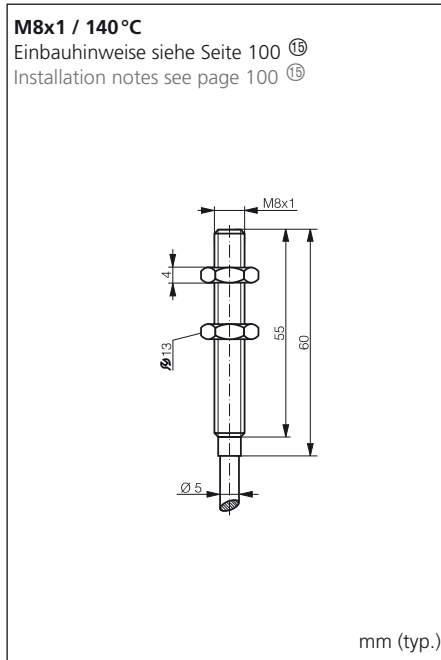

b 3 mm

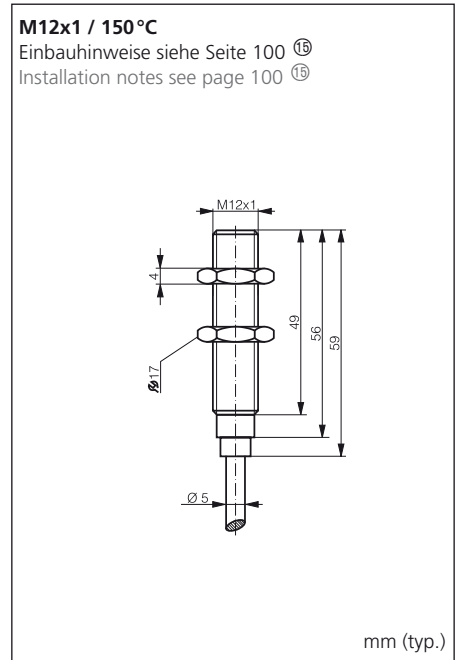

2 mm	3 mm
8x8x1 mm	12x12x1 mm
10...30VDC	10...30VDC
120 mA (80 mA > 100 °C)	120 mA (70 mA > 100 °C)
< 10 mA	< 10 mA
< 2,0 V	< 2,0 V
600 Hz	500 Hz
3...15 %	3...15 %
0...+140 °C	0...+150 °C
500 V	500 V
IP 67	IP 67
VA / LCP	VA / LCP
2,0 m, Silikon / silicone	2,0 m, Silikon / silicone

DCC 08 VH 02 PSK/140

-
-
-
-
-
-
-
-
-
-

DCC 12 VH 03 PSK/150

-
-
-
-
-
-
-
-
-
-

b 5 mm

b 5 mm

nb 8 mm

M18x1 / 180°C
Einbauhinweise siehe Seite 100 ⁽¹⁵⁾
Installation notes see page 100 ⁽¹⁵⁾

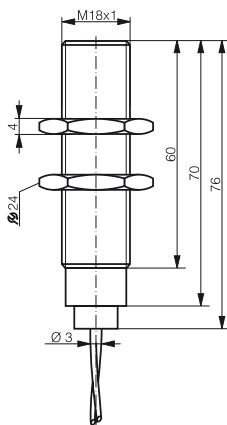

mm (typ.)

M18x1 / 230°C
Externer Kabel-Verstärker
external cable amplifier
Einbauhinweise siehe Seite 100 ⁽¹⁵⁾
Installation notes see page 100 ⁽¹⁵⁾

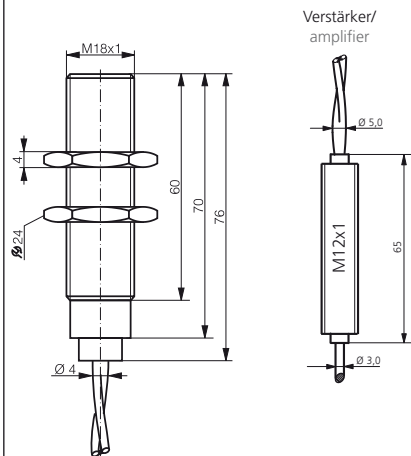

mm (typ.)

M18x1 / 180°C
Einbauhinweise siehe Seite 100 ⁽¹⁵⁾
Installation notes see page 100 ⁽¹⁵⁾

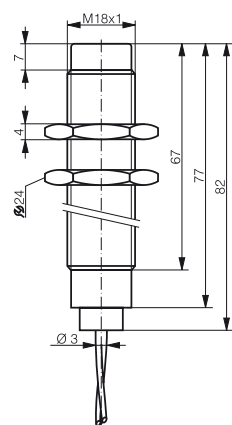

mm (typ.)

	Sensor	Verstärker/amplifier	
5 mm	5 mm	–	8 mm
18x18x1 mm	18x18x1 mm	–	24x24x1 mm
10...30VDC	–	10...30VDC	10...30VDC
150 mA	–	200 mA	150 mA
< 10 mA	–	< 5 mA	< 10 mA
< 2,0 V	–	< 2,0 V	< 2,0 V
400 Hz	–	300 Hz	400 Hz
2...20 %	–	3...15 %	3...15 %
0...+180°C	0...+230°C	0...+70°C	0...+180°C
500 V	500 V	500 V	500 V
IP 67	IP 67	IP 67	IP 67
VA / LCP	VA / LCP	VA	VA / LCP
2,0 m, PTFE	3,0 m, PTFE	2,0 m, PUR	2,0 m, PTFE

DCC 18 VH 05 PSK/180	DCC 18 VH 05 PSK/230/V	DCC 18 VH 08 PSK/180
–	–	–
–	–	–
–	–	–
–	–	–
–	–	–
–	–	–
–	–	–
–	–	–
–	–	–
–	–	–
–	–	–

Induktive Näherungsschalter, hochtemperaturfest Inductive proximity switches, high-temperature resistant

b 10 mm



b 10 mm



nb 15 mm



M30x1,5 / 180°C
Einbauhinweise siehe Seite 100 ⁽¹⁵⁾
Installation notes see page 100 ⁽¹⁵⁾

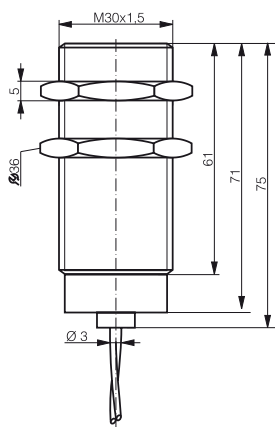

mm (typ.)

M30x1,5 / 230°C
Externer Kabel-Verstärker
external cable amplifier
Einbauhinweise siehe Seite 100 ⁽¹⁵⁾
Installation notes see page 100 ⁽¹⁵⁾

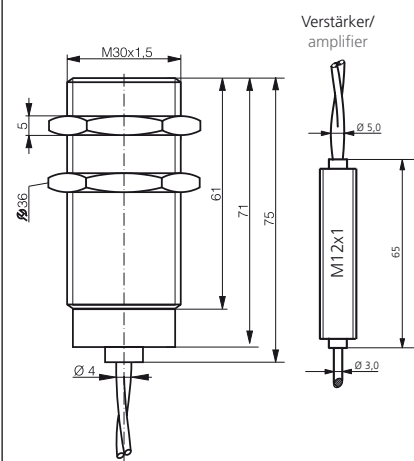

mm (typ.)

M30x1,5 / 180°C
Einbauhinweise siehe Seite 100 ⁽¹⁵⁾
Installation notes see page 100 ⁽¹⁵⁾

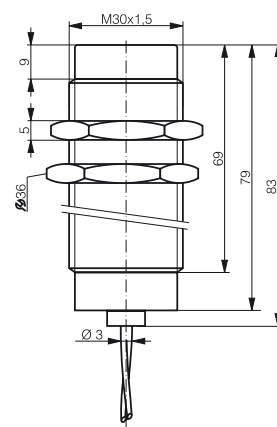

mm (typ.)

	Sensor	Verstärker/amplifier	
10 mm	10 mm	-	15 mm
30x30x1 mm	30x30x1 mm	-	45x45x1 mm
10...30VDC	-	10...30VDC	10...30VDC
150mA	-	200mA	150mA
< 10mA	-	< 5mA	< 10mA
< 2,0 V	-	< 2,0 V	< 2,0 V
200Hz	-	200Hz	200Hz
3... 15%	-	3... 15%	3... 15%
0...+180°C	0...+230°C	0...+70°C	0...+180°C
500 V	500 V	500 V	500 V
IP 67	IP 67	IP 67	IP 67
VA / LCP	VA / LCP	VA	VA / LCP
2,0 m, PTFE	3,0 m, PTFE	2,0m, PUR	2,0 m, PTFE

DCC 30 VH 10 PSK/180

-
-
-
-
-
-
-
-
-
-

DCC 30 VH 10 PSK/230/V

-
-
-
-
-
-
-
-
-
-

DCC 30 VH 15 PSK/180

-
-
-
-
-
-
-
-
-
-

nb 15 mm

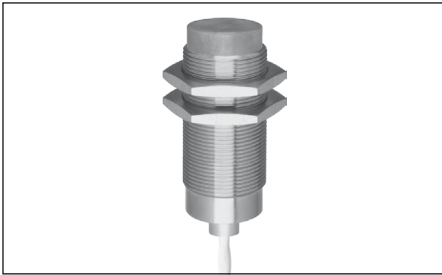

qb 20 mm

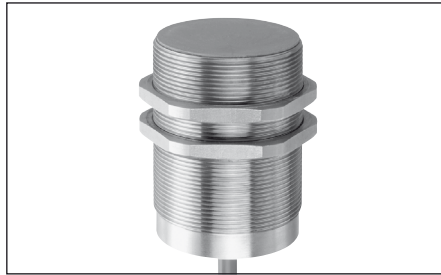

qb 20 mm

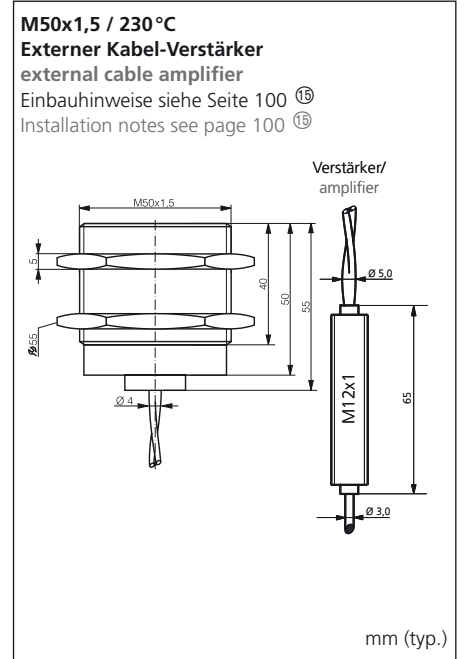
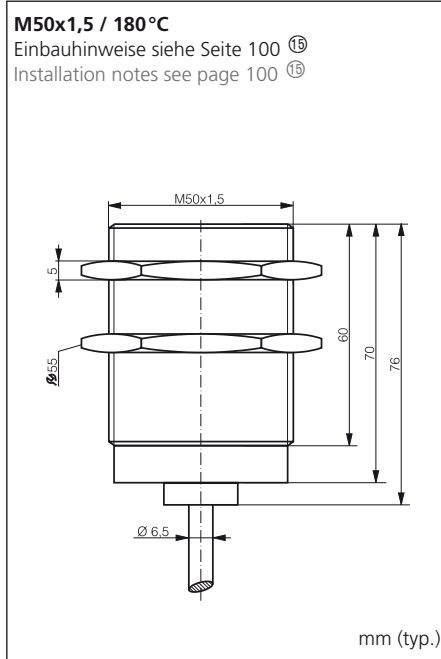
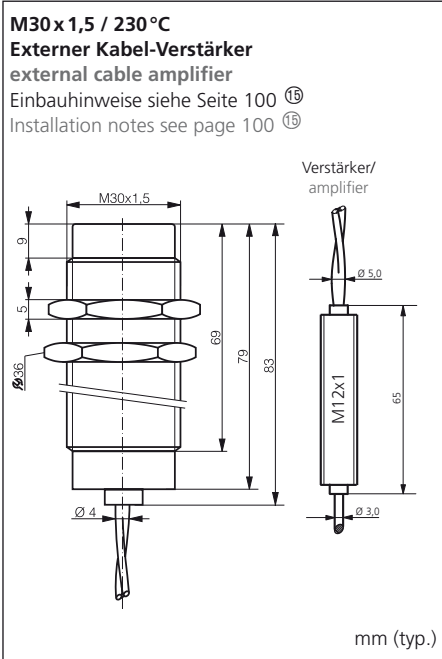
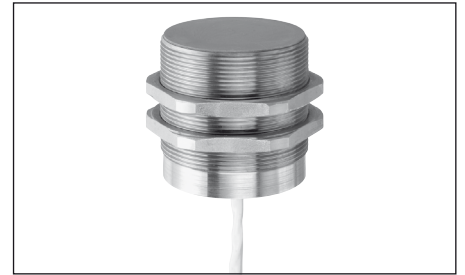

Sensor	Verstärker/amplifier	Sensor	Verstärker/amplifier
15 mm	-	20 mm	-
45x45x1 mm	-	60x60x1 mm	-
-	10 ... 30VDC	-	10 ... 30VDC
-	200mA	-	200mA
-	< 5 mA	-	< 5 mA
-	< 2,0 V	-	< 2,0 V
-	150Hz	-	150Hz
-	3 ... 15 %	-	3 ... 15 %
0 ... +230°C	0 ... +70°C	0 ... +180°C	0 ... +70°C
500 V	500 V	500 V	500 V
IP 67	IP 67	IP 67	IP 67
VA / LCP	VA	VA / LCP	VA
3,0 m, PTFE	2,0 m, PUR	2,0 m, Silikon / silicone	3,0 m, PTFE
DCC 30 VH 15 PSK/230/V		DCC 50 VH 20 PSK/180	
-	-	-	-
-	-	-	-
-	-	-	-
-	-	-	-
-	-	-	-
-	-	-	-
-	-	-	-
-	-	-	-
-	-	-	-
-	-	-	-
-	-	-	-
-	-	-	-
-	-	-	-

Induktive Näherungsschalter, hochtemperaturfest Inductive proximity switches, high-temperature resistant

nb 25 mm

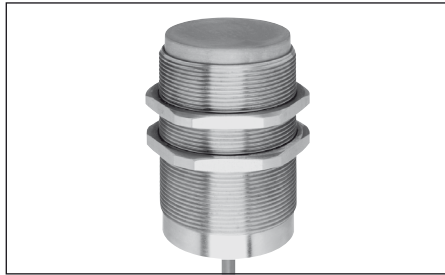

nb 25 mm

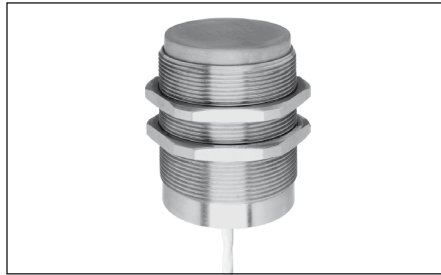

M50x1,5 / 180°C
Einbauhinweise siehe Seite 100 ⁽¹⁵⁾
Installation notes see page 100 ⁽¹⁵⁾

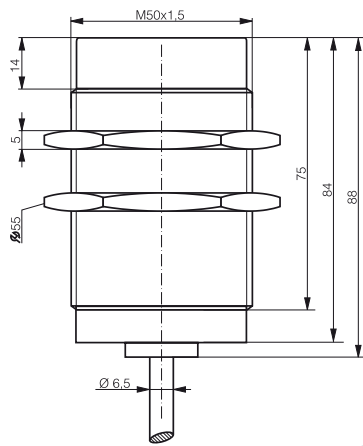

mm (typ.)

M50x1,5 / 230°C
**Externer Kabel-Verstärker/
external cable amplifier**
Einbauhinweise siehe Seite 100 ⁽¹⁵⁾
Installation notes see page 100 ⁽¹⁵⁾

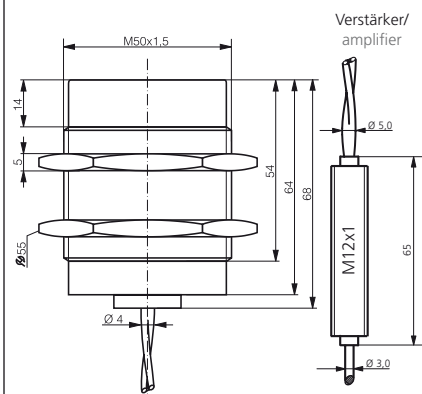

mm (typ.)

	Sensor	Verstärker/amplifier
25 mm	25 mm	-
75x75x1 mm	75x75x1 mm	-
10...30VDC	-	10...30VDC
150mA	-	200mA
< 10mA	-	< 5mA
< 2,0 V	-	< 2,0 V
100 Hz	-	150 Hz
2...20 %	-	3...15 %
0...+180°C	0...+230°C	0...+70°C
500 V	500 V	500 V
IP 67	IP 67	IP 67
VA / LCP	VA / LCP	VA
2,0 m, Silikon / silicone	3,0 m, PTFE	2.0m, PUR

DCC 50 VH 25 PSK/180

-
-
-
-
-
-
-
-
-
-

DCC 50 VH 25 PSK/230/V

-
-
-
-
-
-
-
-
-
-

A series of horizontal light blue lines spanning the width of the page, intended for taking notes.

Induktive Näherungsschalter, tieftemperaturfest

Inductive proximity switches, low-temperature resistant

- Tieftemperaturfeste Ausführung bis -55°C Dauertemperatur
- Schutzart IP 68 und IP 69K (strahlwasserfest)
- Edelstahl-Gehäuse
- Aktive Fläche PTFE
- Low-temperature resistant version down to -55°C permanent temperature
- Protection class IP 68 and IP 69K (hose water proof)
- Stainless steel housing
- Sensing surface PTFE

b 2 mm

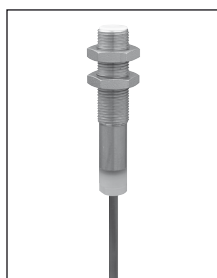

nb 4 mm



b 5 mm

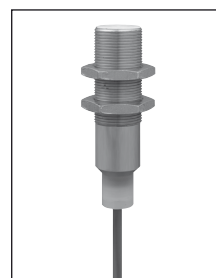

nb 7 mm

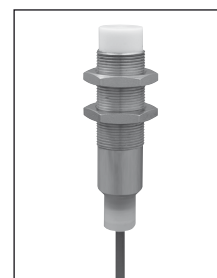

M12x1
Einbauhinweise
siehe Seite 94 ⑧
Installation notes
see page 94 ⑧

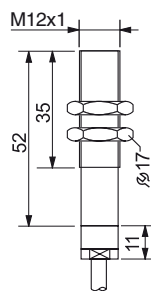

mm (typ.)

M12x1
Einbauhinweise
siehe Seite 94 ⑧
Installation notes
see page 94 ⑧

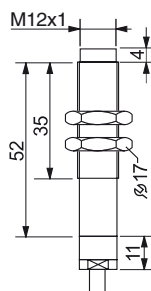

mm (typ.)

M18x1
Einbauhinweise
siehe Seite 94 ⑧
Installation notes
see page 94 ⑧

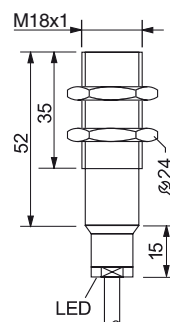

mm (typ.)

M18x1
Einbauhinweise
siehe Seite 94 ⑧
Installation notes
see page 94 ⑧

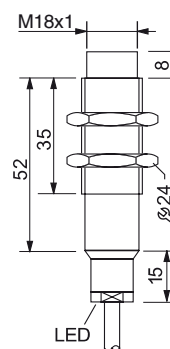

mm (typ.)

2 mm	4 mm	5 mm	7 mm
12 x 12 x 1 mm	12 x 12 x 1 mm	18 x 18 x 1 mm	21 x 21 x 1 mm
10 ... 33 VDC	10 ... 33 VDC	10 ... 33 VDC	10 ... 33 VDC
200 mA	200 mA	200 mA	200 mA
< 4 mA	< 4 mA	< 4 mA	< 4 mA
< 2,0 V	< 2,0 V	< 2,0 V	< 2,0 V
1.000 Hz	1.000 Hz	1.000 Hz	1.000 Hz
10 %	10 %	10 %	10 %
-55 ... +60 °C	-55 ... +60 °C	-55 ... +60 °C	-55 ... +60 °C
500 V	500 V	500 V	500 V
IP 68 (IP 69K)	IP 68 (IP 69K)	IP 68 (IP 69K)	IP 68 (IP 69K)
1.4571 / PTFE	1.4571 / PTFE	1.4571 / PTFE	1.4571 / PTFE
2,0 m, PTFE	2,0 m, PTFE	2,0 m, PTFE	2,0 m, PTFE

DCE 12 VT 02 PSK	DCE 12 VT 04 PSK	DCE 18 VT 05 PSLK	DCE 18 VT 07 PSLK
-	-	-	-
-	-	-	-
-	-	-	-
-	-	-	-
-	-	-	-
-	-	-	-
-	-	-	-
-	-	-	-
-	-	-	-
-	-	-	-
-	-	-	-

A series of horizontal light blue lines spanning the width of the page, intended for taking notes.

Induktive Näherungsschalter mit Analogausgang

Inductive proximity switches with analog output

qb 0...4 mm

qb 0...4 mm

qb 0...4 mm

qb 0...6 mm

■ Analoger Spannungsausgang
0...10 V

■ Analoger Stromausgang
4...20 mA

■ Analog voltage output
0...10 V

■ Analog current output
4...20 mA

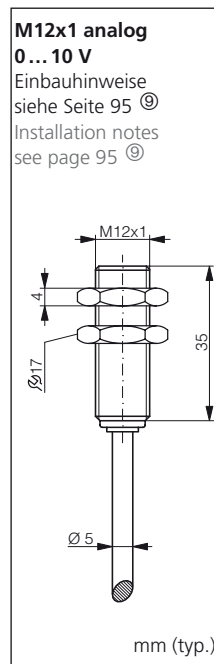
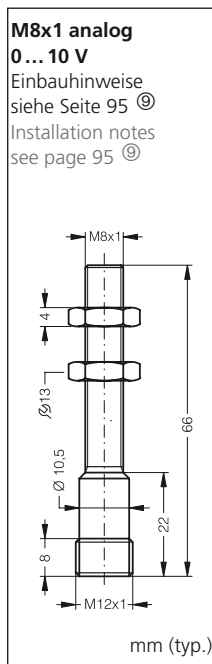
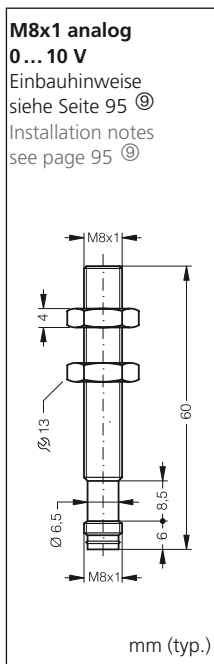
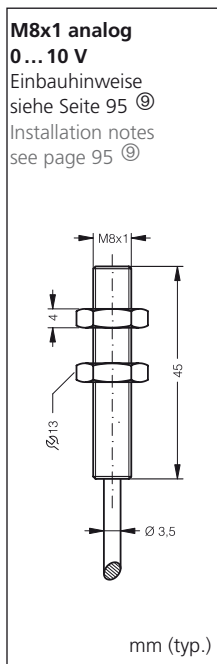
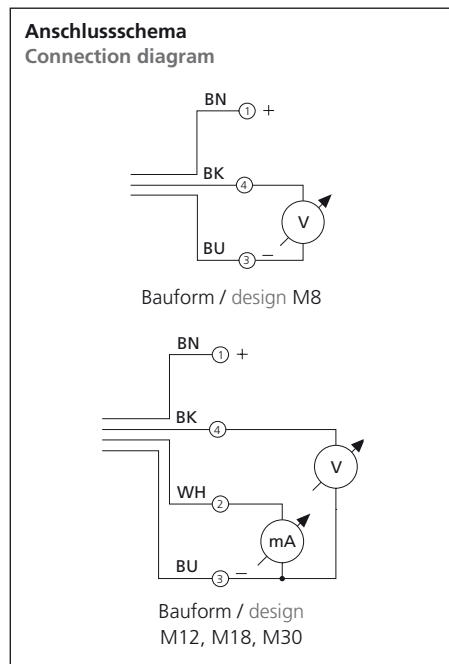
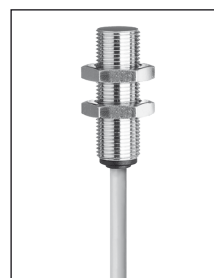
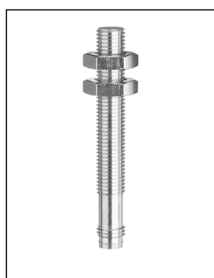
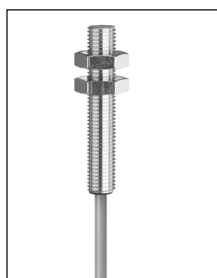

0...4 mm	0...4 mm	0...4 mm	0...6 mm
12x12x1 mm	12x12x1 mm	12x12x1 mm	18x18x1 mm
15...30VDC	15...30VDC	15...30VDC	15...30VDC
-	-	-	-
< 10 mA	< 10 mA	< 10 mA	< 12 mA
-	-	-	-
1.600 Hz	1.600 Hz	1.600 Hz	1.000 Hz
-	-	-	-
-25...+70 °C	-25...+70 °C	-25...+70 °C	-25...+45 °C
500 V	500 V	500 V	500 V
IP 67	IP 67	IP 67	IP 67
Ms	Ms	Ms	Ms
2.0 m, PUR	-	-	2.0 m, PUR

DCC 08 M 04/10 AK DCC 08 M 04/10 AK-TSL DCC 08 M 04/10 AK-IBS DCC 12 M 06/10 AK

TK...

VK...

qb 0...6 mm

qb 0...6 mm

qb 0...6 mm

qb 0...10 mm

qb 0...10 mm

qb 0...10 mm

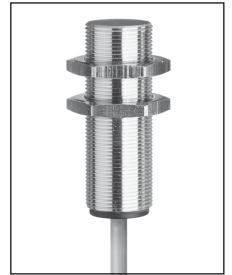
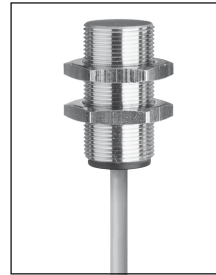
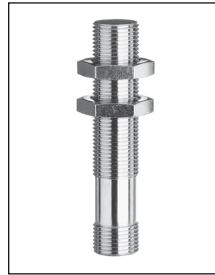
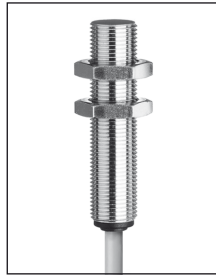

M12x1 analog
0...10 V

Einbauhinweise
siehe Seite 95 ⑨
Installation notes
see page 95 ⑨

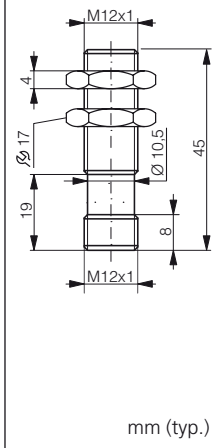

M12x1 analog
0...10 V / 4...20 mA

Einbauhinweise
siehe Seite 95 ⑨
Installation notes
see page 95 ⑨

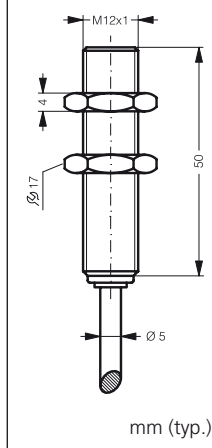

M12x1 analog
0...10 V / 4...20 mA

Einbauhinweise
siehe Seite 95 ⑨
Installation notes
see page 95 ⑨

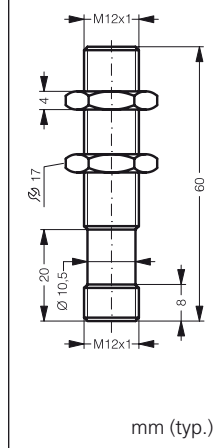

M18x1 analog
0...10 V / 4...20 mA

Einbauhinweise
siehe Seite 95 ⑨
Installation notes
see page 95 ⑨

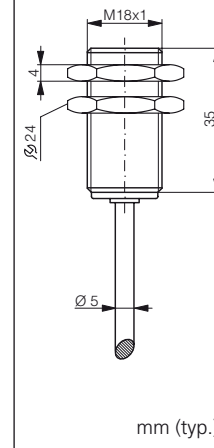

M18x1 analog
0...10 V / 4...20 mA

Einbauhinweise
siehe Seite 95 ⑨
Installation notes
see page 95 ⑨

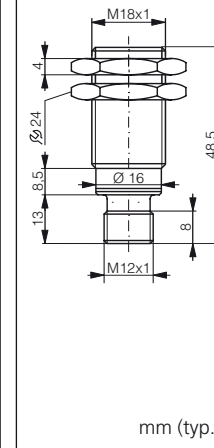

M18x1 analog
0...10 V / 4...20 mA

Einbauhinweise
siehe Seite 95 ⑨
Installation notes
see page 95 ⑨

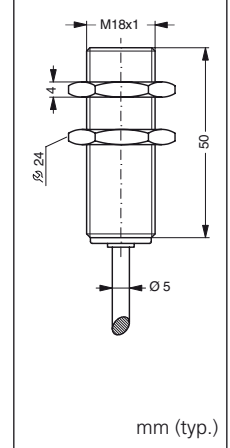

0...6 mm	0...6 mm	0...6 mm	0...10 mm	0...10 mm	0...10 mm
18x18x1 mm	18x18x1 mm	18x18x1 mm	30x30x1 mm	30x30x1 mm	30x30x1 mm
15...30VDC	15...30VDC	15...30VDC	15...30VDC	15...30VDC	15...30VDC
-	-	-	-	-	-
< 12 mA	< 12 mA	< 12 mA	< 12 mA	< 12 mA	< 12 mA
-	-	-	-	-	-
1.000 Hz	1.000 Hz	1.000 Hz	500 Hz	500 Hz	500 Hz
-	-	-	-	-	-
-25...+45°C	-25...+45°C	-25...+45°C	-25...+45°C	-25...+45°C	-25...+45°C
500 V	500 V	500 V	500 V	500 V	500 V
IP 67	IP 67	IP 67	IP 67	IP 67	IP 67
Ms	Ms	Ms	Ms	Ms	Ms
-	2.0 m, PUR	-	2.0 m, PUR	-	2.0 m, PUR

-	-	-	-	-	-
-	-	-	-	-	-
-	-	-	-	-	-
-	-	-	-	-	-
DCC 12 M 06/10 AK-IBS	DCC 12 M 06/10 AIK	DCC 12 M 06/10 AIK-IBS	DCC 18 M 10/10 AIK	DCC 18 M 10/10 AIK-IBS	DCC 18 M 10/10 AIK
-	-	-	-	-	-
-	-	-	-	-	-
-	-	-	-	-	-
VK...	-	VK.../4	-	VK.../4	-
-	-	-	-	-	-

Induktive Näherungsschalter mit Analogausgang

Inductive proximity switches with analog output

qb 0 ... 10 mm qb 0 ... 20 mm qb 0 ... 20 mm nb 0 ... 40 mm qb 0 ... 20 mm qb 0 ... 20 mm

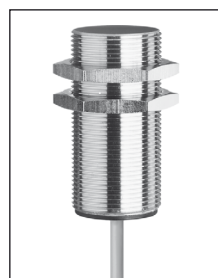
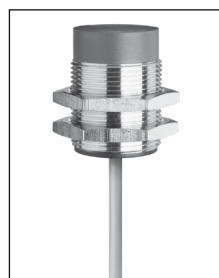

analog
0 ... 10 V / 4 ... 20 mA
Einbauhinweise
siehe Seite 95 ⓘ
Installation notes
see page 95 ⓘ

mm (typ.)

M30 x 1,5 analog
0 ... 10 V / 4 ... 20 mA
Einbauhinweise
siehe Seite 95 ⓘ
Installation notes
see page 95 ⓘ

mm (typ.)

M30 x 1,5 analog
0 ... 10 V / 4 ... 20 mA
Einbauhinweise
siehe Seite 95 ⓘ
Installation notes
see page 95 ⓘ

mm (typ.)

M30 x 1,5 analog
0 ... 10 V / 4 ... 20 mA
Einbauhinweise
siehe Seite 95 ⓘ
Installation notes
see page 95 ⓘ

mm (typ.)

M30 x 1,5 analog
0 ... 10 V / 4 ... 20 mA
Einbauhinweise
siehe Seite 95 ⓘ
Installation notes
see page 95 ⓘ

mm (typ.)

M30 x 1,5 analog
0 ... 10 V / 4 ... 20 mA
Einbauhinweise
siehe Seite 95 ⓘ
Installation notes
see page 95 ⓘ

mm (typ.)

0 ... 10 mm	0 ... 20 mm	0 ... 20 mm	0 ... 40 mm	0 ... 20 mm	0 ... 20 mm
30x30x1 mm	60x60x1 mm	60x60x1 mm	120x120x1 mm	60x60x1 mm	60x60x1 mm
15 ... 30VDC	15 ... 30VDC	15 ... 30VDC	15 ... 30VDC	15 ... 30VDC	15 ... 30VDC
-	-	-	-	-	-
< 12 mA	< 12 mA	< 12 mA	< 12 mA	< 12 mA	< 12 mA
-	-	-	-	-	-
500 Hz	500 Hz	500 Hz	100 Hz	500 Hz	500 Hz
-	-	-	-	-	-
-25 ... +45 °C	-25 ... +45 °C	-25 ... +45 °C	-25 ... +70 °C	-25 ... +45 °C	-25 ... +45 °C
500 V	500 V	500 V	500 V	500 V	500 V
IP 67	IP 67	IP 67	IP 67	IP 67	IP 67
Ms	Ms	Ms	Ms	Ms	Ms
-	2.0m, PUR	-	2.0m, PUR	2.0m, PUR	-
-	-	-	-	-	-
-	-	-	-	-	-
-	-	-	-	-	-
-	-	-	-	-	-
DCC 18 M 10/10 AIK-IBS	DCCK 30 M 20/10 AIK	DCCK 30 M 20/10 AIK-IBS	DCCK 30 M 40/10 AIK	DCC 30 M 20/10 AIK	DCC 30 M 20/10 AIK-IBS
-	-	-	-	-	-
-	-	-	-	-	-
-	-	-	-	-	-
VK .../4	-	VK .../4	-	-	VK .../4
-	-	-	-	-	-

qb 0...4 mm

qb 0...4 mm

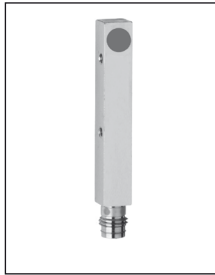

Ansprechdiagramm (Beispiel)
Response diagram (example)

0... 10 V / 4...20mA

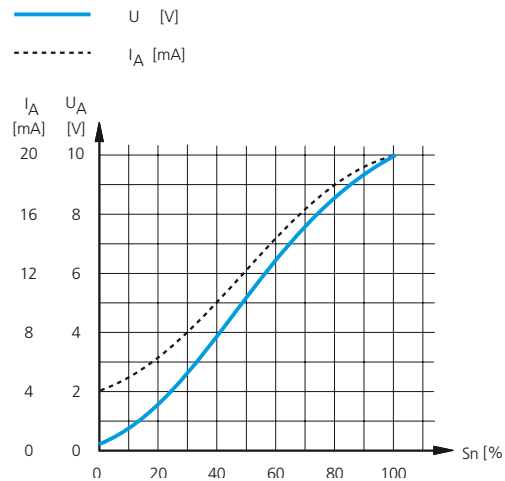

□ 8x8mm analog
0... 10 V
 Einbauhinweise
 siehe Seite 95 ⑨
 Installation notes
 see page 95 ⑨

mm (typ.)

□ 8x8mm analog
0... 10 V
 Einbauhinweise
 siehe Seite 95 ⑨
 Installation notes
 see page 95 ⑨

mm (typ.)

0... 4 mm	0... 4 mm	Spannungsausgang	Voltage output	0... 10 V, 10 mA max.
12 x 12 x 1 mm	12 x 12 x 1 mm	Stromausgang	Current output	4... 20 mA
15... 30VDC	15... 30VDC	Last Stromausgang	Load current output	
–	–	bei 4... 20 mA	at 4... 20 mA	500 Ω bei / at 15 V
< 10 mA	< 10 mA			1.000 Ω bei / at 30 V
–	–	Kabellänge	Cable length	< 300 m
1.600 Hz	1.600 Hz			
–	–			
-25... +70 °C	-25... +70 °C			
500 V	500 V			
IP 67	IP 67			
Ms	Ms			
2.0 m, PUR	–			
–	–			
–	–			
–	–			
–	–			
DCCQ 08 M 04/10 AK	DCCQ 08 M 04/10 AK-TSL			
–	–			
–	–			
–	–			
–	TK...			
–	–			

Induktive Näherungsschalter nach NAMUR | Inductive proximity switches acc. to NAMUR

- Ausführung gemäß NAMUR (DIN 19234)
- Betriebsspannung 5...30VDC
- Ausgangsstrom < 1 mA bei bedämpfem Näherungsschalter
- Ausgangsstrom > 2,2 mA bei unbedämpfem Näherungsschalter
- Versions in accordance with NAMUR (DIN 19234)
- Service voltage 5...30VDC
- Output current < 1 mA with energized proximity switch
- Output current > 2,2 mA with de-energized proximity switch

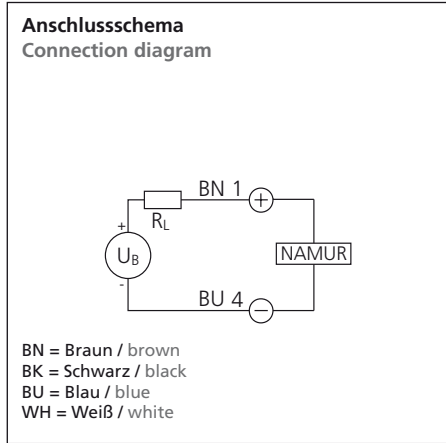

b 1,5 mm



Ø 6,5 mm
Einbauhinweise siehe Seite 85 ①
Installation notes see page 85 ①

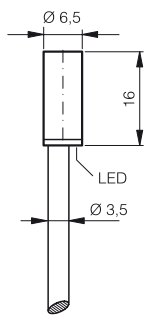

mm (typ.)

b 1,5 mm



Ø 6,5 mm
Einbauhinweise siehe Seite 85 ①
Installation notes see page 85 ①

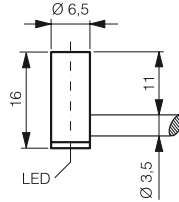

mm (typ.)

b 1,5 mm

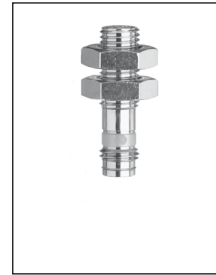

M8x1
Einbauhinweise siehe Seite 85 ①
Installation notes see page 85 ①

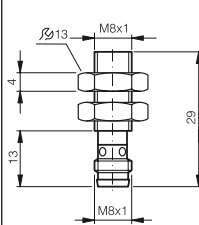

mm (typ.)

b 1,5 mm

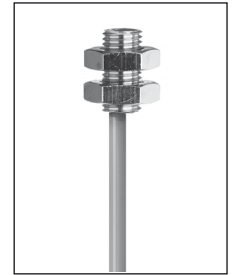

M8x1
Einbauhinweise siehe Seite 85 ①
Installation notes see page 85 ①

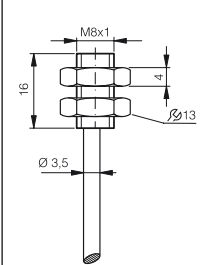

mm (typ.)

	1,5 mm	1,5 mm	1,5 mm	1,5 mm
nach NAMUR	6,5x6,5x1 mm	6,5x6,5x1 mm	8x8x1 mm	8x8x1 mm
bedämpft / unbedämpft	7,7...9VDC	7,7...9VDC	7,7...9VDC	7,7...9VDC
	< 1 mA / > 2,2 mA	< 1 mA / > 2,2 mA	< 1 mA / > 2,2 mA	< 1 mA / > 2,2 mA
	–	–	–	–
	10.000 Hz	10.000 Hz	10.000 Hz	10.000 Hz
	–	–	–	–
	-25...+70 °C	-25...+70 °C	-25...+70 °C	-25...+70 °C
	500 V	500 V	500 V	500 V
	IP 67	IP 67	IP 67	IP 67
	VA	VA	VA	VA
	2.0 m, PVC	2.0 m, PVC	–	2.0 m, PVC
	–	–	–	–
	–	–	–	–
	–	–	–	–
	–	–	–	–
	–	–	–	–
	DCCK 6.5 V 1.5 NAMUR	DCCKR 6.5 V 1.5 NAMUR	DCC 08 V 1.5 TSL NAMUR	DCC 08 V 1.5 NAMUR
	–	–	–	–
	–	–	–	–
	–	–	TK...	–
	–	–	–	–

Übertragungsfunktion
Transfer function

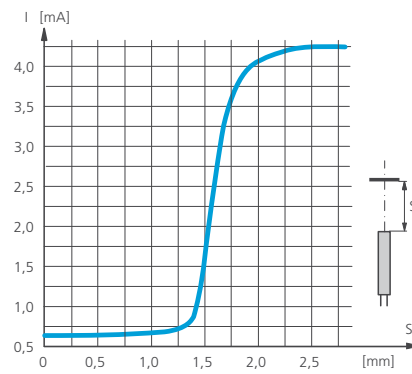

Arbeitswiderstand nach NAMUR
Leitungslängemax.

1.000 Ω
300 m

Induktive Näherungsschalter für Allspannung Inductive proximity switches, NO/NC

- Betriebsspannung 20 ... 250 V AC/DC
- Schutzart IP 67

- Service voltage 20 ... 250 V AC/DC
- Protection class IP 67

b 2 mm

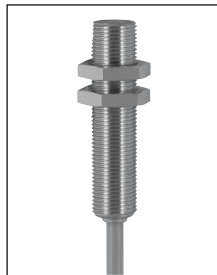

b 2 mm

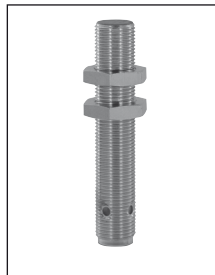

nb 4 mm

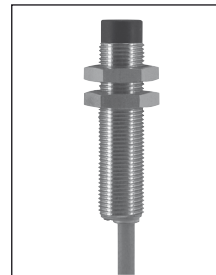

nb 4 mm



M12x1

Einbauhinweise
siehe Seite 85 ①
Installation notes
see page 85 ①

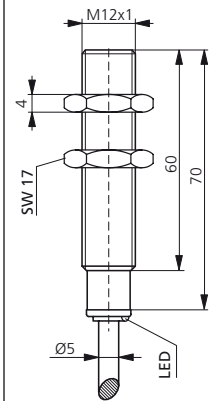

mm (typ.)

M12x1

Einbauhinweise
siehe Seite 85 ①
Installation notes
see page 85 ①

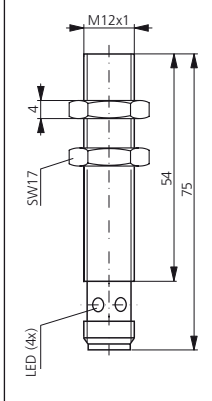

mm (typ.)

M12x1

Einbauhinweise
siehe Seite 85 ①
Installation notes
see page 85 ①

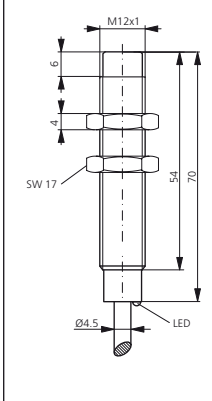

mm (typ.)

M12x1

Einbauhinweise
siehe Seite 85 ①
Installation notes
see page 85 ①

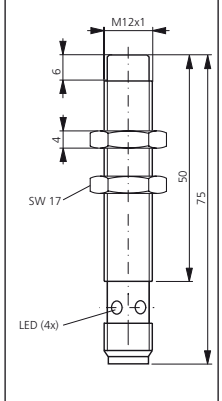

mm (typ.)

2 mm	2 mm	4 mm	4 mm
12 x 12 x 1 mm	12 x 12 x 1 mm	12 x 12 x 1 mm	12 x 12 x 1 mm
20 ... 250 V AC/DC	20 ... 250 V AC/DC	20 ... 250 V AC/DC	20 ... 250 V AC/DC
300 mA	300 mA	300 mA	300 mA
< 2,0 mA	< 2,0 mA	< 2,0 mA	< 2,0 mA
< 5,0 V	< 5,0 V	< 5,0 V	< 5,0 V
30 Hz	30 Hz	30 Hz	30 Hz
< 15 %	< 15 %	< 15 %	< 15 %
-25 ... +70 °C	-25 ... +70 °C	-25 ... +70 °C	-25 ... +70 °C
500 V	500 V	500 V	500 V
IP 67	IP 67	IP 67	IP 67
Ms	Ms	Ms	Ms
2 m, PVC	–	2 m, PVC	–

–

–

–

–

–

–

–

–

–

–

–

–

–

–

–

–

UCC 12 M 02 SL
UCC 12 M 02 OL

UCC 12 M 02 S-IBSL
UCC 12 M 02 O-IBSL*

UCC 12 M 04 SL
UCC 12 M 04 OL

UCC 12 M 04 S-IBSL
UCC 12 M 04 O-IBSL*

–

VK ...
VK .../4*

–

VK ...
VK .../4*

–

–

–

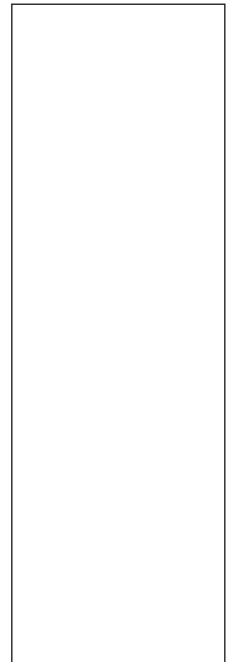
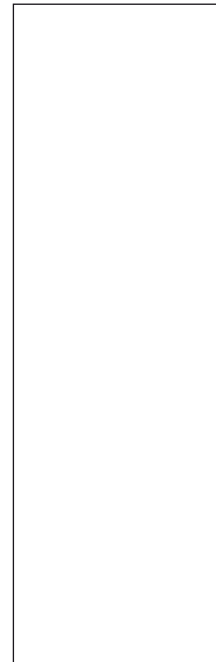
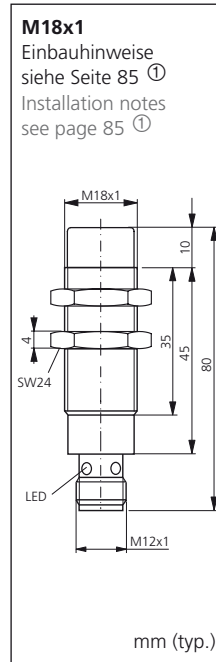
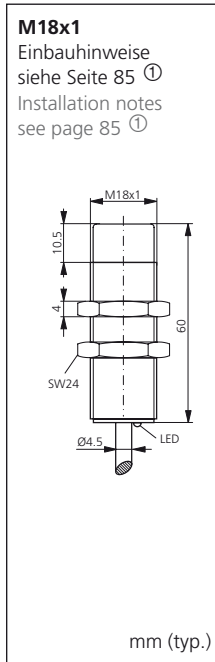
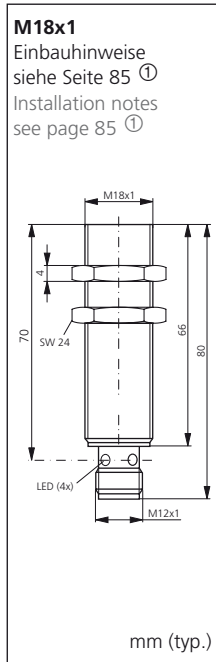
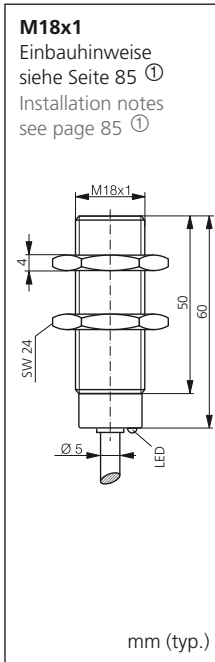
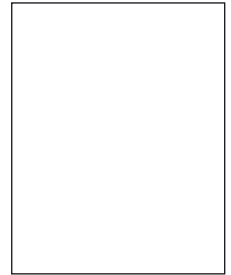
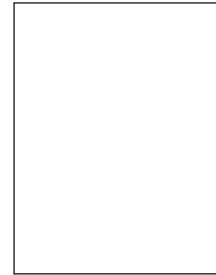
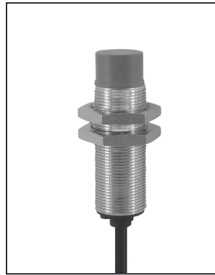
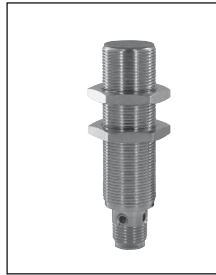
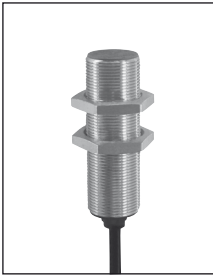
b 5 mm
b 5 mm
nb 8 mm
nb 8 mm

5 mm	8 mm	8 mm	8 mm
18x18x1 mm	18x18x1 mm	24x24x1 mm	24x24x1 mm
20...250 V AC/DC	20...250 V AC/DC	20...250 V AC/DC	20...250 V AC/DC
300 mA	300 mA	300 mA	300 mA
< 2,0mA	< 2,0mA	< 2,0mA	< 2,0mA
< 5,0 V	< 5,0 V	< 5,0 V	< 5,0 V
30Hz	30Hz	30Hz	30Hz
< 15 %	< 15 %	< 15 %	< 15 %
-25...+70 °C	-25...+70 °C	-25...+70 °C	-25...+70 °C

IP 67	IP 67	IP 67	IP 67
Ms	Ms	Ms	Ms
2 m, PVC	–	2 m, PVC	–

–	–	–	–
–	–	–	–
–	–	–	–
–	–	–	–
–	–	–	–

UCC 18 M 05 SL	UCC 18 M 05 S-IBSL	UCC 18 M 08 SL	UCC 18 M 08 S-IBSL
UCC 18 M 05 OL	UCC 18 M 05 O-IBSL	UCC 18 M 08 OL	UCC 18 M 08 O-IBSL

–	VK ...	–	VK ...
–	VK.../4*	–	VK.../4*

Induktive Näherungsschalter für Allspannung

Inductive proximity switches, NO/NC

- Betriebsspannung 20 ... 250 V AC/DC
- Schutzart IP 67

- Service voltage 20 ... 250 V AC/DC
- Protection class IP 67

b 10 mm



b 10 mm



M30x1

Einbauhinweise
siehe Seite 85 ①
Installation notes
see page 85 ①

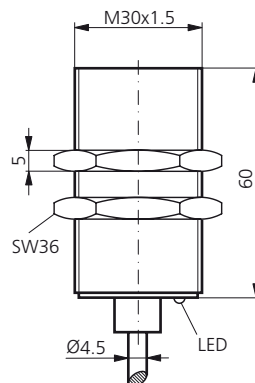

mm (typ.)

M30x1

Einbauhinweise
siehe Seite 85 ①
Installation notes
see page 85 ①

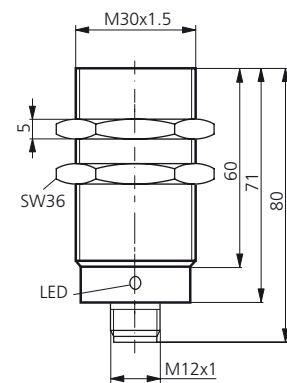

mm (typ.)

10 mm
30x30x1 mm
20 ... 250 V AC/DC
300 mA
< 2,0 mA
< 5,0 V
30 Hz
< 15 %
-25 ... +70 °C
500 V
IP 67
Ms
2 m, PVC

10 mm
30x30x1 mm
20 ... 250 V AC/DC
300 mA
< 2,0 mA
< 5,0 V
30 Hz
< 15 %
-25 ... +70 °C
500 V
IP 67
Ms
-

UCC 30 M 10 SL
UCC 30 M 10 OL

UCC 30 M 10 S-IBSL
UCC 30 M 10 O-IBSL

VK ...
VK .../4*

nb 15 mm

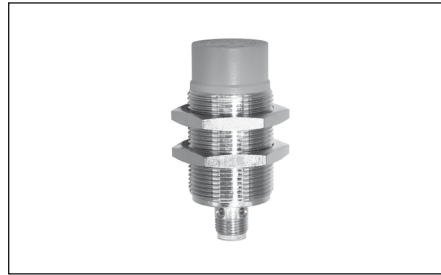
nb 15 mm

b 20 mm

M30x1

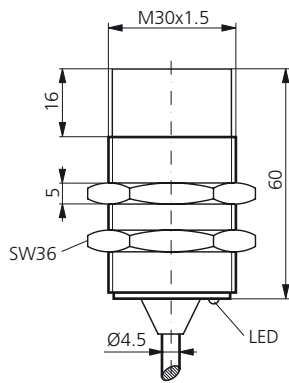
Einbauhinweise
siehe Seite 85 ①
Installation notes
see page 85 ①



mm (typ.)

M30x1

Einbauhinweise
siehe Seite 85 ①
Installation notes
see page 85 ①

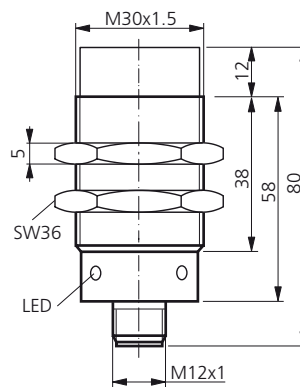

mm (typ.)

120x40x40 mm

Einbauhinweise
siehe Seite 85 ①
Installation notes
see page 85 ①

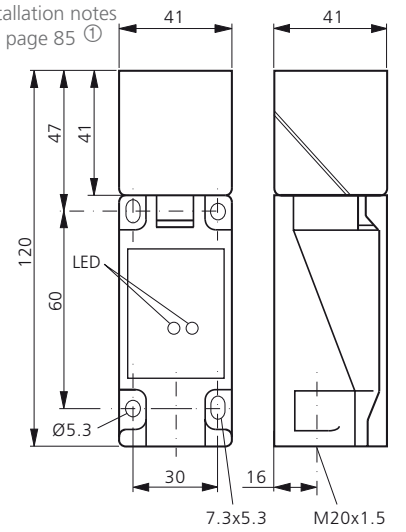

mm (typ.)

15 mm

45x45x1 mm

20...250 V AC/DC

300 mA

< 2,0 mA

< 5,0 V

30 Hz

< 15 %

-25...+70 °C

500 V

IP 67

Ms

2 m, PVC

15 mm

45x45x1 mm

20...250 V AC/DC

300 mA

< 2,0 mA

< 5,0 V

30 Hz

< 15 %

-25...+70 °C

500 V

IP 67

Ms

-

20 mm

60x60x1 mm

20...250 V AC/DC

400 mA

≤ 2 mA

< 5,0 V

15 Hz

< 15 %

-25...+70 °C

500 V

IP 67

PA 6.6

-

UCC 30 M 15 SL

UCC 30 M 15 OL

UCC 30 M 15 S-IBSL

UCC 30 M 15 O-IBSL

VK ...

VK.../4*

UCCR 40 K 20 SO-KL

Kapazitive Näherungsschalter | Capacitive proximity switches

- Erfassung von elektrisch leitenden und elektrisch nicht leitenden Materialien
- Erfassung von flüssigen, pulverförmigen und festen Materialien
- Erfassung durch Behälterwandungen oder Verpackungen möglich
- Durch verschiedenste Gehäusematerialien für fast alle Anwendungsgebiete geeignet
- Empfindlichkeit einstellbar
- Selbstanpassende Sensoren verfügbar (typabhängig)
- Detection of electrically conductive and non-conductive materials
- Detection of liquids, powdery and solid materials
- Detection possible even through containers and packages
- Suitable for multiple purposes thanks to diverse housing materials
- Adjustable sensitivity
- Self-adjusting sensors available (depending on model)

b 1,5 mm



b 1,5 mm



nb 3 mm

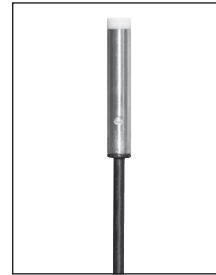

nb 3 mm



Ø 6,5 mm
Einbauhinweise
siehe Seite 103 ¹⁰
Installation notes
see page 103 ¹⁰

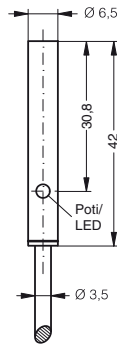

mm (typ.)

Ø 6,5 mm
Einbauhinweise
siehe Seite 103 ¹⁰
Installation notes
see page 103 ¹⁰

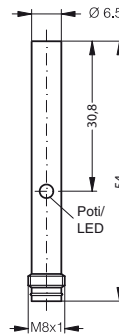

mm (typ.)

Ø 6,5 mm
Einbauhinweise
siehe Seite 103 ¹⁰ (A)
Installation notes
see page 103 ¹⁰ (A)

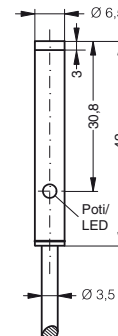

mm (typ.)

Ø 6,5 mm
Einbauhinweise
siehe Seite 103 ¹⁰ (A)
Installation notes
see page 103 ¹⁰ (A)

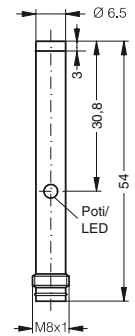

mm (typ.)

1,5 mm, einstellb./adjust.

1,5 mm, einstellb./adjust.

3 mm, einstellb. / adjust.

3 mm, einstellb. / adjust.

11 ... 30 VDC

11 ... 30 VDC

11 ... 30 VDC

11 ... 30 VDC

50 mA

50 mA

50 mA

50 mA

< 10 mA

< 10 mA

< 10 mA

< 10 mA

< 2,0 V

< 2,0 V

< 2,0 V

< 2,0 V

100 Hz

100 Hz

100 Hz

100 Hz

15 %

15 %

15 %

15 %

-10 ... +70 °C

-10 ... +70 °C

-10 ... +70 °C

-10 ... +70 °C

500 V

500 V

500 V

500 V

IP 65

IP 65

IP 65

IP 65

VA

VA

VA

VA

2.0 m, PUR

-

2.0 m, PUR

-

KDC 6.5 V 1.5 PSLK

KDC 6.5 V 1.5 PSK-TSL

KDC 6.5 V 03 PSLK

KDC 6.5 V 03 PSK-TSL

KDC 6.5 V 1.5 POLK

KDC 6.5 V 1.5 POK-TSL

KDC 6.5 V 03 POLK

KDC 6.5 V 03 POK-TSL

-

-

-

-

-

-

-

-

-

-

-

-

-

-

-

-

-

-

-

-

-

-

-

-

-

TK...

-

TK...

-

-

-

-

b 1,5 mm

b 1,5 mm

nb 3 mm

nb 3 mm

b 4 mm

b 4 mm



M8x1
Einbauhinweise
siehe Seite 103 ¹⁰
Installation notes
see page 103 ¹⁰

mm (typ.)

M8x1
Einbauhinweise
siehe Seite 103 ¹⁰
Installation notes
see page 103 ¹⁰

mm (typ.)

M8x1
Einbauhinweise
siehe Seite 103 ¹⁰ ^B
Installation notes
see page 103 ¹⁰ ^B

mm (typ.)

M8x1
Einbauhinweise
siehe Seite 103 ¹⁰ ^B
Installation notes
see page 103 ¹⁰ ^B

mm (typ.)

M12x1
Einbauhinweise
siehe Seite 103 ¹⁰
Installation notes
see page 103 ¹⁰

mm (typ.)

M12x1
Einbauhinweise
siehe Seite 103 ¹⁰
Installation notes
see page 103 ¹⁰

mm (typ.)

1,5 mm, einstellb./adjust.	1,5 mm, einstellb./adjust.	3 mm, einstellb. / adjust.	3 mm, einstellb. / adjust.	4 mm, einstellb. / adjust.	4 mm, einstellb. / adjust.
–	–	–	–	–	–
10 ... 30VDC	10 ... 30VDC	10 ... 30VDC	10 ... 30VDC	10 ... 35VDC	10 ... 35VDC
50 mA	50 mA	50 mA	50 mA	200 mA	200 mA
< 10 mA	< 10 mA	< 10 mA	< 10 mA	< 10 mA	< 10 mA
< 1,0 V	< 1,0 V	< 1,0 V	< 1,0 V	< 1,0 V	< 1,0 V
100 Hz	100 Hz	100 Hz	100 Hz	100 Hz	100 Hz
15 %	15 %	15 %	15 %	15 %	15 %
-10 ... +70 °C	-10 ... +70 °C	-10 ... +70 °C	-10 ... +70 °C	-30 ... +70 °C	-30 ... +70 °C
500 V	500 V	500 V	500 V	500 V	500 V
IP 65	IP 65	IP 65	IP 65	IP 65	IP 65
VA	VA	VA	VA	VA	VA
2.0m, PUR	–	2.0m, PUR	–	2.0m, PUR	–

KDC 08 V 1.5 PSLK	KDC 08 V 1.5 PSK-TSL	KDC 08 V 03 PSLK	KDC 08 V 03 PSK-TSL	KDC 12 M 04 PSLK	KDC 12 M 04 PSK-IBSL
KDC 08 V 1.5 POLK	KDC 08 V 1.5 POK-TSL	KDC 08 V 03 POLK	KDC 08 V 03 POK-TSL	KDC 12 M 04 POLK	KDC 12 M 04 POK-IBSL
–	–	–	–	–	–
–	–	–	–	–	–
–	–	–	–	–	–
–	–	–	–	–	–
v	–	–	–	–	–
–	–	–	–	–	–
–	TK...	–	TK...	–	VK...
–	–	–	–	–	–

Kapazitive Näherungsschalter | Capacitive proximity switches

nb 8 mm



nb 8 mm



b 8 mm

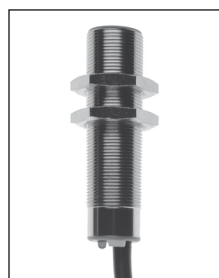

b 8 mm



nb 15 mm

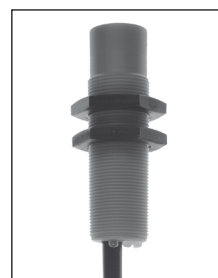

nb 15 mm



M12x1
Einbauhinweise
siehe Seite 103 ⁽¹⁰⁾ ^(A)
Installation notes
see page 103 ⁽¹⁰⁾ ^(A)

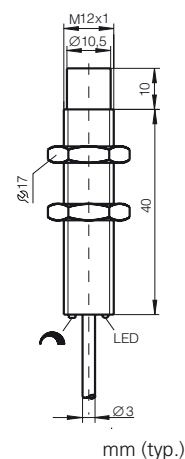

M12x1
Einbauhinweise
siehe Seite 103 ⁽¹⁰⁾
Installation notes
see page 103 ⁽¹⁰⁾

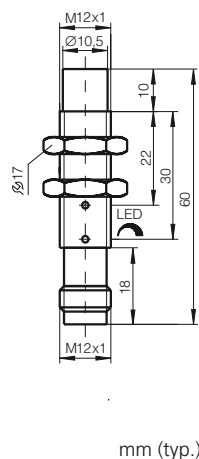

M18x1
Einbauhinweise
siehe Seite 103 ⁽¹⁰⁾
Installation notes
see page 103 ⁽¹⁰⁾

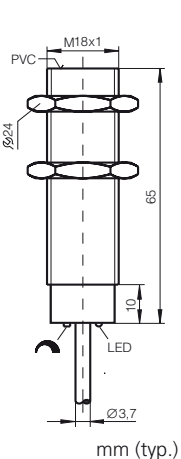

M18x1
Einbauhinweise
siehe Seite 103 ⁽¹⁰⁾
Installation notes
see page 103 ⁽¹⁰⁾

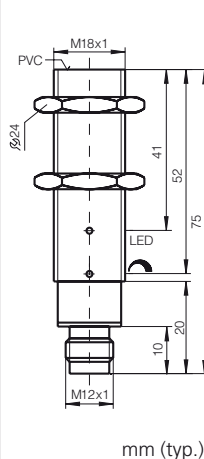

M18x1
Einbauhinweise
siehe Seite 103 ⁽¹⁰⁾ ^(A)
Installation notes
see page 103 ⁽¹⁰⁾ ^(A)

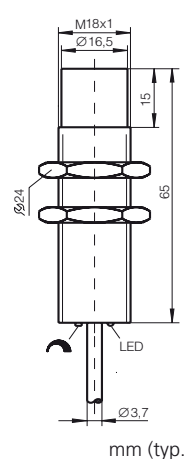

M18x1
Einbauhinweise
siehe Seite 103 ⁽¹⁰⁾ ^(A)
Installation notes
see page 103 ⁽¹⁰⁾ ^(A)

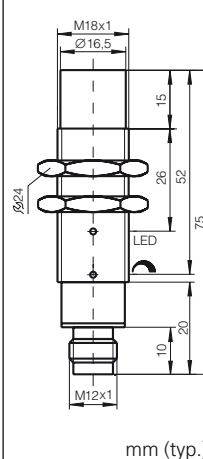

8 mm, einstellb. / adjust.

8 mm, einstellb. / adjust.

8 mm, einstellb. / adjust.

8 mm, einstellb. / adjust.

15 mm, einstellb. / adjust.

15 mm, einstellb. / adjust.

10 ... 35VDC

10 ... 35VDC

10 ... 35VDC

10 ... 35VDC

10 ... 35VDC

10 ... 35VDC

200 mA

200 mA

200 mA

200 mA

200 mA

200 mA

< 10 mA

< 10 mA

< 10 mA

< 10 mA

< 10 mA

< 10 mA

< 1,0 V

< 1,0 V

< 1,0 V

< 1,0 V

< 1,0 V

< 1,0 V

100 Hz

100 Hz

100 Hz

100 Hz

100 Hz

100 Hz

15 %

15 %

15 %

15 %

15 %

15 %

-30 ... +70 °C

-30 ... +70 °C

-30 ... +70 °C

-30 ... +70 °C

-30 ... +70 °C

-30 ... +70 °C

500 V

500 V

500 V

500 V

500 V

500 V

IP 65

IP 65

IP 67 *

IP 67 *

IP 67 *

IP 67 *

Ks

Ks

VA

VA

Ks

Ks

2.0m, PUR

-

2.0m, PVC

-

2.0m, PVC

-

KDC 12 K 08 PSLK

KDC 12 K 08 POLK

KDC 12 K 08 PSK-IBSL

KDC 12 K 08 POK-IBSL

KDC 18 M 08 PSLK

KDC 18 M 08 POLK

KDC 18 M 08 PSK-IBSL

KDC 18 M 08 POK-IBSL

KDC 18 K 15 PSLK

KDC 18 K 15 POLK

KDC 18 K 15 PSK-IBSL

KDC 18 K 15 POK-IBSL

-

-

-

-

-

-

-

-

-

-

-

-

-

-

-

-

-

-

-

-

-

-

-

-

-

-

-

-

-

-

-

-

-

-

-

-

-

-

-

-

-

-

-

VK...

-

VK...

-

VK...

-

-

-

-

-

-

* IP 67 nur bei aufgeschraubter Schutzschraube / IP 67 only with protection screw screwed-on

b 20 mm

b 20 mm

nb 30 mm

M30x1,5

Einbauhinweise
siehe Seite 103 [ⓐ]
Installation notes
see page 103 [ⓐ]

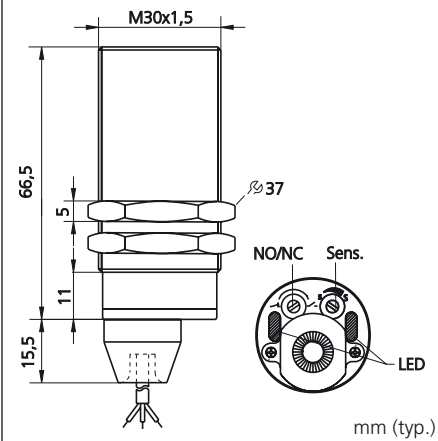
M30x1,5

Einbauhinweise
siehe Seite 103 [ⓐ]
Installation notes
see page 103 [ⓐ]

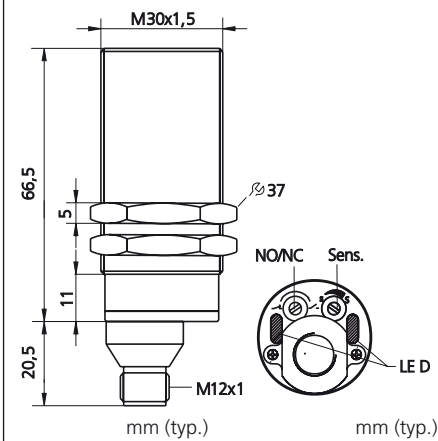
M30x1,5

Einbauhinweise
siehe Seite 103 [ⓐ]
Installation notes
see page 103 [ⓐ]

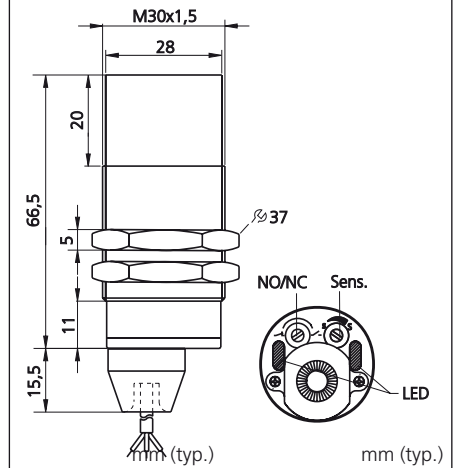

20 mm, einstellbar / adjustable

20 mm, einstellbar / adjustable

30 mm, einstellbar / adjustable

10 ... 35VDC

10 ... 35VDC

10 ... 35VDC

300 mA, NO/NC

300 mA, NO/NC

300 mA, NO/NC

< 10 mA

< 10 mA

< 10 mA

< 1,8 V

< 1,8 V

< 1,8 V

100 Hz

100 Hz

100 Hz

15 %

15 %

15 %

-30 ... +70 °C

-30 ... +70 °C

-30 ... +70 °C

500 V

500 V

500 V

IP 67 (frontseitig / front), IP 64 (rückseitig / rear)

IP 67 (frontseitig / front), IP 64 (rückseitig / rear)

IP 68 (frontseitig / front), IP 64 (rückseitig / rear)

VA

VA

Ks

2.0m, PVC

2.0m, PVC

KDC 30 M 20 PSOLK

KDC 30 M 20 PSOK-BSL

KDC 30 K 30 PSOLK

VK...

Kapazitive Näherungsschalter | Capacitive proximity switches

nb 30 mm



b 25 mm



b 25 mm

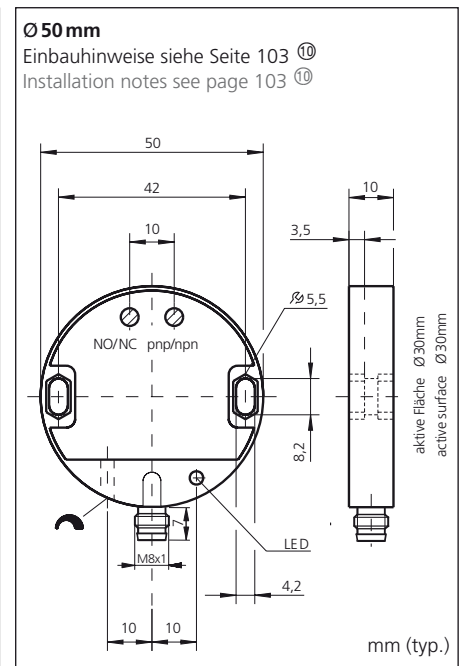
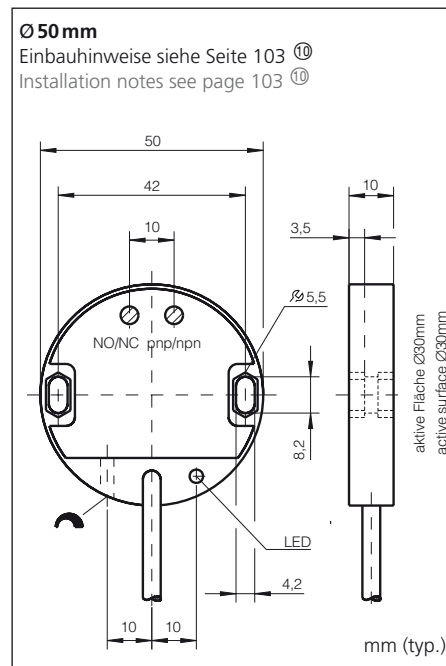
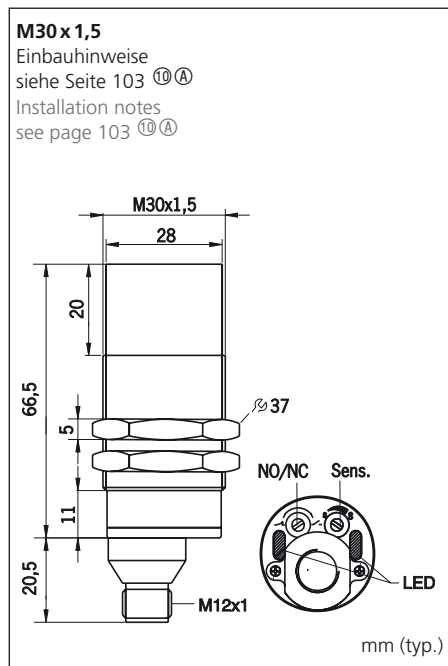

30 mm, einstellbar / adjustable

25 mm, einstellbar / adjustable

25 mm, einstellbar / adjustable

10 ... 35 VDC

10 ... 30 VDC

10 ... 30 VDC

300 mA, NO/NC

150 mA, NO/NC

150 mA, NO/NC

< 10 mA

< 15 mA

< 15 mA

< 1,8 V

< 2 V

< 2 V

100 Hz

50 Hz

50 Hz

15 %

3 ... 20 %

3 ... 20 %

-30 ... +70 °C

-30 ... +70 °C

-30 ... +70 °C

500 V

500 V

500 V

IP 68 (frontseitig / front), IP 64 (rückseitig / rear)

IP 67

IP 65

Ks

Ks

Ks

-

2.0 m, PUR

-

KDC 30 K 30 PSOK-BSL

KDC 50 K 25 PMSOLK (pnp / npn)

KDC 50 K 25 PMSOK-TSL (pnp / npn)

VK...

TK...

nb 25 mm

einstellbar, selbstkompensierend
adjustable, self-compensating



Ø 50 mm

Einbauhinweise siehe Seite 103 ¹⁰
Installation notes see page 103 ¹⁰

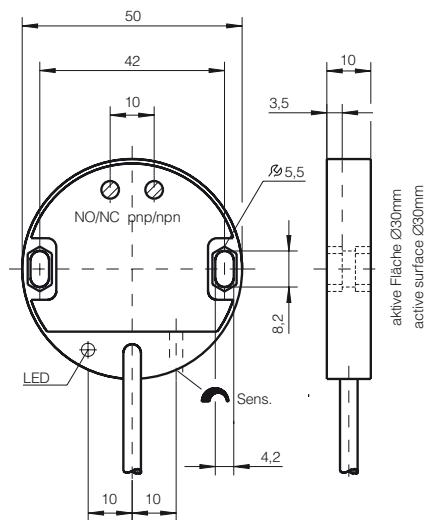

mm (typ.)

einstellbar, selbstkompensierend / adjustable, self-compensating

-
- 10 ... 35 VDC
- 300 mA, NO/NC
- < 20 mA
- < 1,8 V
- 2 Hz
-
- 10 ... +60 °C
- 500 V
- IP 67
- Ks (POM)
- 2.0m, PVC

-
-
-

KDC 50 K 25S PSOLK

-
-
-
-
-
-

Kapazitive Näherungsschalter | Capacitive proximity switches

b 8 mm



b 8 mm



34 x 16 x 8 mm

Einbauhinweise siehe Seite 103 ¹⁰
 Installation notes see page 103 ¹⁰

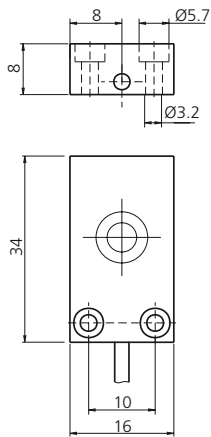

mm (typ.)

34 x 16 x 8 mm

Einbauhinweise siehe Seite 103 ¹⁰
 Installation notes see page 103 ¹⁰

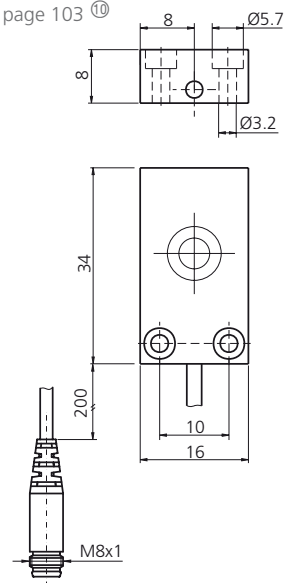

mm (typ.)

8 mm, einstellbar / adjustable

-
- 12 ... 30VDC
- 50 mA
- < 10 mA
- < 1,5 V
- 100 Hz
- 15 %
- 30 ... +70 °C
- 500 V
- IP 67
- Ks (PP)
- 2.0 m, PUR

KDCR 16 K 08 PSLK
 KDCR 16 K 08 POLK

-
-
-
-
-
-
-
-

8 mm, einstellbar / adjustable

-
- 12 ... 30VDC
- 50 mA
- < 10 mA
- < 1,5 V
- 100 Hz
- 15 %
- 30 ... +70 °C
- 500 V
- IP 67
- Ks (PP)
- 0,2 m, PUR

KDCR 16 K 08 PSK-K-TSL
 KDCR 16 K 08 POK-K-TSL

-
-
-
-
-
-
-
-
- TK...**
-

nb 8 mm

einstellbar, selbstkompensierend
adjustable, self-compensating



nb 8 mm

einstellbar, selbstkompensierend
adjustable, self-compensating



34 x 16 x 8 mm

Einbauhinweise siehe Seite 103 ¹⁰
Installation notes see page 103 ¹⁰

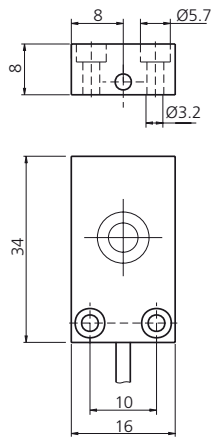

mm (typ.)

34 x 16 x 8 mm

Einbauhinweise siehe Seite 103 ¹⁰
Installation notes see page 103 ¹⁰

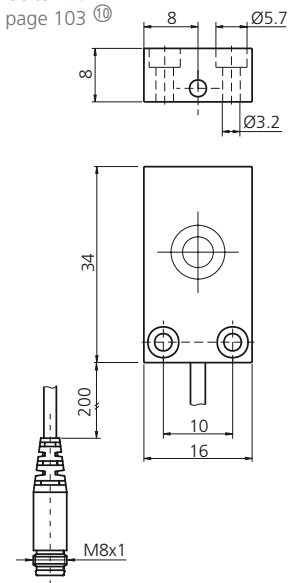

mm (typ.)

einstellbar, selbstkompensierend / adjustable, self-compensating

–

12 ... 30 VDC

50 mA

< 10 mA

< 1,5 V

2 Hz

–

-30 ... +70 °C

500 V

IP 67

Ks (PP)

2.0 m, PUR

KDCR 16 K 08S PSLK

KDCR 16 K 08S POLK

–

–

–

–

–

–

–

–

einstellbar, selbstkompensierend / adjustable, self-compensating

–

12 ... 30 VDC

50 mA

< 10 mA

< 1,5 V

2 Hz

–

-30 ... +70 °C

500 V

IP 67

Ks (PP)

0,2 m, PUR

KDCR 16 K 08S PSK-K-TSL

KDCR 16 K 08S POK-K-TSL

–

–

–

–

–

–

–

TK...

–

Zubehör | Accessories

Sensorhalter für zylindrische Sensoren mit Ø3 mm bis M30 / Mounting bracket for cylindrical sensors with Ø3 mm up to M30

Sensorhalter Mounting bracket	Type Model
Ø A = 3 mm	SH 3
ohne Festanschlag / without limit stop	
Ø A = 4 mm	SH 4
ohne Festanschlag / without limit stop	
Ø A = 5 mm	SH 5
ohne Festanschlag / without limit stop	
Ø A = 6,5 mm	SH 6.5
ohne Festanschlag / without limit stop	
Ø A = 8 mm	SH 8
ohne Festanschlag / without limit stop	
Ø A = 8 mm	SH 8 A
mit Festanschlag / with limit stop	

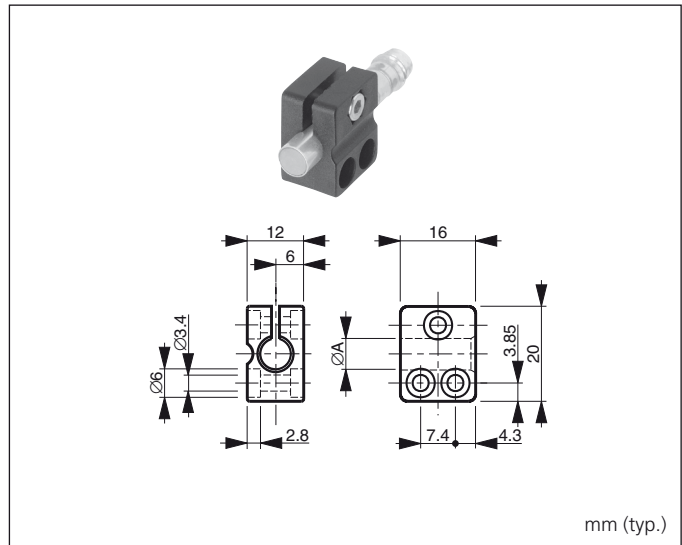

Sensorhalter Mounting bracket	Type Model
Ø 12 mm	SH 12
ohne Festanschlag / without limit stop	
Ø 12 mm	SH 12 A
mit Festanschlag / with limit stop	

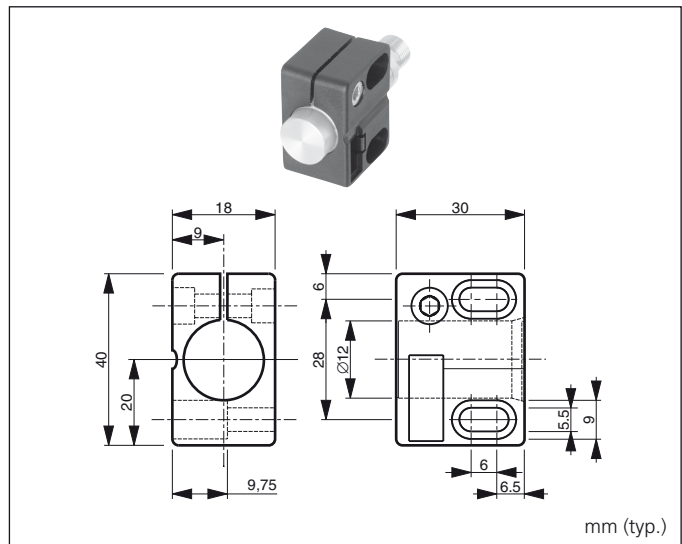

Sensorhalter Mounting bracket	Type Model
Ø 18 mm	SH 18
ohne Festanschlag / without limit stop	
Ø 18 mm	SH 18 A
mit Festanschlag / with limit stop	

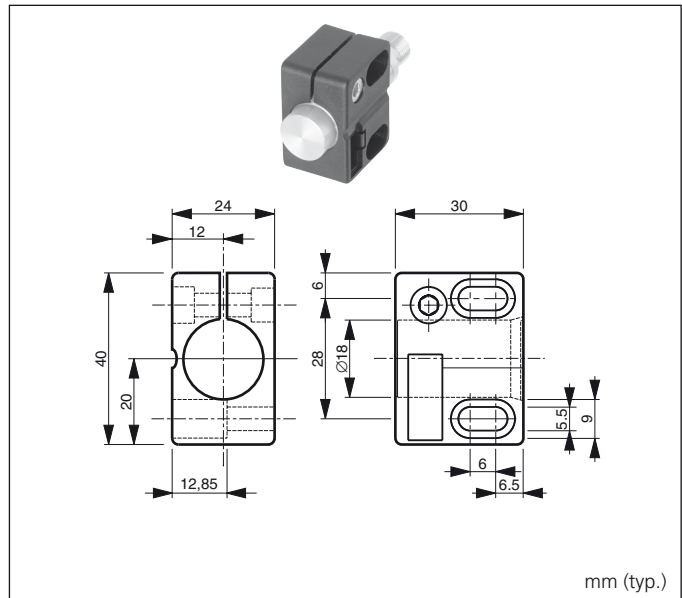

Weitere Montagesysteme in Datenblatt D 105
Further assembly systems at data sheet in D 105

Sensorhalter	Type
Mounting bracket	Model
Ø 30 mm	SH 30
ohne Festanschlag / without limit stop	
Ø 30 mm	SH 30 A
mit Festanschlag / with limit stop	

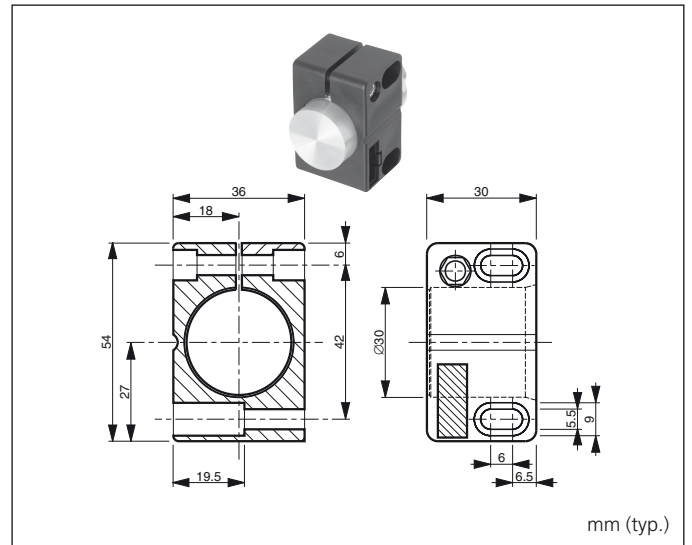

Unterteil horizontal für Sensorhalter	Type
Bottom part horizontal for mounting bracket	Model
SH 12 / SH 12 A / SH 18 / SH 18 A	SHUW 12/18

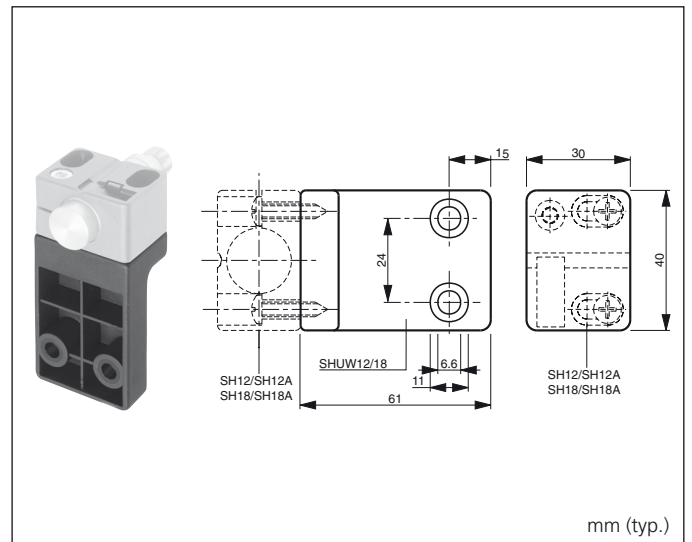

Unterteil vertikal für Sensorhalter	Type
Bottom part vertical for mounting bracket	Model
SH 12 / SH 12 A / SH 18 / SH 18 A	SHUF 12/18

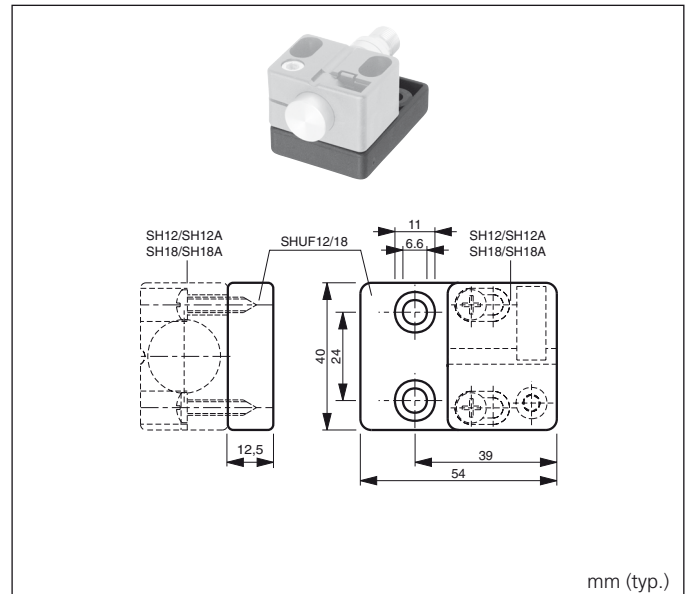

Weitere Montagesysteme in Datenblatt D 105
Further assembly systems at data sheet in D 105

Induktive Näherungsschalter | Inductive proximity switches

Begriffserklärungen

Funktion

Mit induktiven Näherungsschaltern können Objekte aus leitenden Materialien (Metalle) erfasst werden. Der Schaltabstand ist dabei wesentlich vom Material des zu erkennenden Objektes, der Einbautart und der Größe der aktiven Sensorfläche abhängig.

Bündiger Einbau

Diese Näherungsschalter können in alle Materialien (Metalle/Nichtmetalle) so eingebaut werden, dass die aktive Sensorfläche frontseitig bündig mit dem umgebenden Material abschließt. Sie besitzen folgende Vorteile:

- Bündiger Einbau in leitende Materialien (Metalle).
- Schutz der aktiven Fläche vor mechanischen Beschädigungen.
- Geringerer Einfluss äußerer Störfelder.
- Geringerer seitlicher Abstand zum nächsten Näherungsschalter.

Quasi bündiger Einbau

Diese Näherungsschalter besitzen einen höheren Schaltabstand als Näherungsschalter für bündigen Einbau. Sie dürfen aber in leitende Materialien nur quasi bündig, d. h. nicht ganz bündig, eingebaut werden. Die Näherungsschalter müssen um ein geringes Maß aus der Einbaufäche hervorstehen (siehe Einbauhinweise). Der bündige Einbau in nichtleitende Materialien ist zulässig.

Nichtbündiger Einbau

Diese Näherungsschalter dürfen in leitende Materialien nicht bündig eingebaut werden. Sie besitzen den größtmöglichen Schaltabstand. Für diese Näherungsschalter gelten besondere Einbauvorschriften. Der bündige Einbau in nichtleitende Materialien ist zulässig.

Schaltabstand

Der Schaltabstand S_n wird gemäß EN 50010 mit einer sich in axialer Richtung annähernden quadratischen Messplatte (St37, 1 mm stark) bestimmt. Die Kantenlänge der Messplatte muss dem Durchmesser der aktiven Fläche oder $3 \times S_n$, wenn dieser Wert größer ist als der Durchmesser der aktiven Fläche, entsprechen. Der Schaltabstand S_n ist der Abstand, bei dem die Messplatte einen Signalwechsel am Ausgang des Näherungsschalters hervorruft.

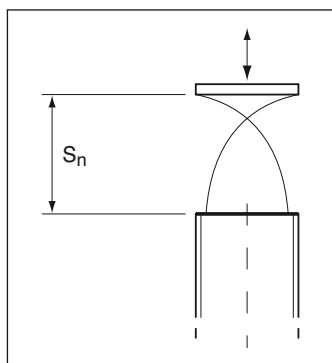

Reduktionsfaktor

Der angegebene Schaltabstand S_n ist auf eine quadratische Messplatte (St37, 1 mm stark) nach EN 50010 bezogen. Bei anderen Metallen als St37 ergeben sich reduzierte Schaltabstände (siehe Einbauhinweise). Diese Korrekturfaktoren sind nur Anhaltswerte. Bei unterschiedlichen Legierungen differieren diese Werte.

nnp-Ausgang

Die Last wird zwischen positiver Versorgungsspannung und dem Ausgang des Näherungsschalters angeschlossen. Der nnp-Transistor des Näherungsschalters schaltet die Last gegen 0 Volt.

pnp-Ausgang

Die Last wird zwischen dem Ausgang des Näherungsschalters und 0 Volt angeschlossen. Der pnp-Transistor des Näherungsschalters schaltet die Last gegen die positive Versorgungsspannung.

Schließer, NO

Im Normalzustand (kein Metall vor der aktiven Sensorfläche) ist der Ausgangstransistor gesperrt (ausgeschaltet). Befindet sich Metall innerhalb des Schaltabstandes vor der aktiven Sensorfläche, ist der Ausgangstransistor leitend (eingeschaltet).

Öffner, NC

Im Normalzustand (kein Metall vor der aktiven Sensorfläche) ist der Ausgangstransistor leitend (eingeschaltet). Befindet sich Metall innerhalb des Schaltabstandes vor der aktiven Fläche, ist der Ausgangstransistor gesperrt (ausgeschaltet).

Explanations

Function

Inductive proximity switches are used for detecting objects that consist of conductive (metallic) materials. The operating distance depends primarily on the material of the object to be detected, the kind of mounting and the size of the sensing face.

Flush mounting

These proximity switches can be mounted in all materials (metallic/non-metallic), so that the sensing face is flush with the front of the surrounding material. They have the following advantages:

- Flush mounting (see installation notes) in conductive materials (metals).
- Protection of the active zone from mechanical damage.
- Lower influence of external interference fields.
- Lower lateral distance to the next proximity switch.

Quasi-flush mounting

These proximity switches possess a higher operating distance than proximity switches for flush-mounting. They may be mounted into conductive materials only quasi-flush mounted, i.e. not completely flush mounted. The proximity switches must exceed a little bit over the installation surface (see installation notes). Flush mounting in non-conductive materials is permissible.

Non-flush mounting

These proximity switches must not be flush-mounted with the surface of conductive materials. They have the greatest possible operating distance. Special installation notes are applicable for these proximity switches. Flush mounting in non-conductive materials is permissible.

Operating distance

The operating distance S_n is determined in accordance with EN 50010 with a square measuring plate (St 37, 1 mm thick) approaching in axial direction. The edge length of the measuring plate must be equivalent to the diameter of the sensing face, or $3 \times S_n$, if this value is greater than the diameter of the sensing face. The operating distance S_n is the distance at which the measuring plate causes a signal change at the output of the proximity switch.

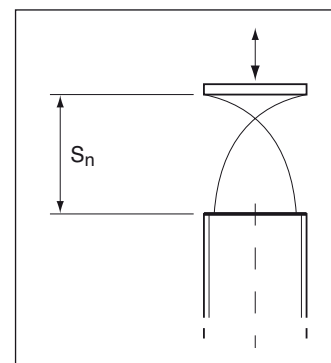

Reduction factor

The indicated operating distance S_n refers to a square measuring plate (St37, 1 mm thick), according to EN 50010. For other metals than St37, reduced operating distances are to be considered (see installation notes).

nnp-output

The load is connected between the positive supply voltage and the output of the proximity switch. The npn transistor of the proximity switch connects the load to 0 Volt.

pnp-output

The load is connected between the output of the proximity switch and 0 Volt. The pnp transistor of the proximity switch connects the load to the positive supply voltage.

NO contact (normally open)

In the normal condition (no metal in front of the sensing face), the output transistor is inhibited (switched off). If metal is located within the operating distance in front of the sensing face, the output transistor is conductive (switched on).

NC contact (normally closed)

In the normal condition (no metal in front of the sensing face), the output transistor is conductive (switched on). If metal is located within the operating distance in front of the sensing face, the output transistor is inhibited (switched off).

Einbauhinweise ①

Maximale Einschraubängen

Durch die in DIN 13 festgelegten Gewindedemaße und Toleranzen ergeben sich folgende maximale Einschraubängen:

M4	5 mm
M5	5 mm
M8	8 mm
M12	8 mm
M18	8 mm
M30	16 mm

Längere Gewinde sind entsprechend freizubohren.

Leitungsführung

Um eine sichere und zuverlässige Funktion zu gewährleisten, muss Folgendes beachtet werden:

- Anschlussleitungen der Näherungsschalter nicht zusammen mit Leitungen höherer Spannungen oder mit Anschlussleitungen hoher induktiver Lasten (Schütze, Ventile usw.) verlegen. Sicherheitsabstände einhalten.
- Auf der Versorgungsspannung dürfen keine Spannungsspitzen auftreten. Nicht geregelte Spannungsversorgungen mit einem Kondensator puffern.

Anzugsmomente

Durch zu hohe Anzugsmomente der Muttern können Näherungsschalter beschädigt werden.

Die maximal zulässigen Anzugsmomente beachten:

M4	0,8 Nm
M5	1,5 Nm
M8	4 Nm
M12	10 Nm
M18	20 Nm
M30	40 Nm

Bündiger Einbau (b)

Bei bündigem Einbau bzw. bei Parallelmontage sind folgende Abstände einzuhalten:

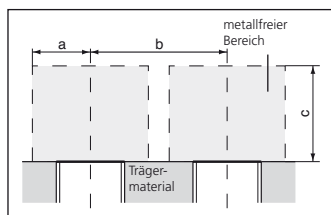

Bauform	Abstand [mm]		
	a	b	c
Ø3	2	3	1,8
M4	2	4	1,8
Ø4	2	4	2,4
□5	3,3	5	2,4
M5	3,3	5	2,4
Ø6,5	5	9,5	4,5
□8	5,5	10	4,5
M8	5,5	10	4,5
M12	8	18	6
M18	14	32	15
M30	25	60	30
DCCR 44 K 20	30	80	40
DCCR 40	30	80	40

Nichtbündiger Einbau (nb)

Bei nicht bündigem Einbau bzw. bei Parallelmontage sind folgende Abstände einzuhalten:

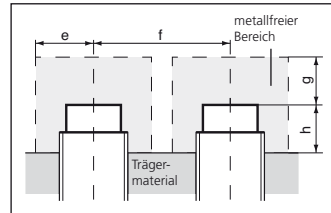

Bauform	Abstand [mm]			
	e	f	g	h
M8	9	16	7,5	8
M12	12	28	12	6
M18	20	50	24	10
M30	30	75	40	15
DCCR 44	80	160	90	40
DCCR 40	90	180	100	40

Normmessplatten und Faktoren

Bauform	Normmessplatte [mm]
Ø3	3x3x1
M4	4x4x1
Ø4	4x4x1
□5	5x5x1
M5	5x5x1
Ø6,5	6,5x6,5x1
□8	8x8x1
M8	8x8x1
M12	12x12x1
M18 b	18x18x1
M18 nb	24x24x1
M30 b	30x30x1
M30 nb	45x45x1
DCCR 44 b	45x45x1
DCCR 44 nb	105x105x1
DCCR 44 K 20	60x60x1

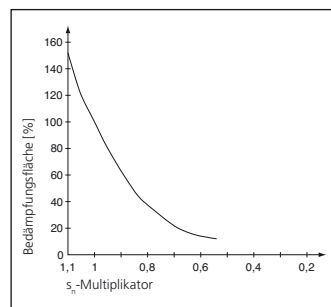

Geometrieinfluss

Bei Folien ist eine Verringerung des Schaltabstandes zu erwarten.

Installation notes ①

Maximum screw-in length

Due to the thread dimensions and tolerances stipulated in DIN 13, the following maximum screw-in lengths are valid:

M4	5 mm
M5	5 mm
M8	8 mm
M12	8 mm
M18	8 mm
M30	16 mm

Clearance drilling is required for longer threads.

Cable routing

To ensure a secure and reliable function, the following must be taken into account:

- Do not route the connection cables of the proximity switches together with the proximity switches together with higher voltage cables or with connection cables of higher inductive loads (contactors, valves, etc.) maintain safety distances.
- No peaks may occur in the power supply. Use a capacitor to buffer uncontrolled power supplies.

Tightening torque

Proximity switches can be damaged by an excessive tightening torque of the nuts. Please note the maximum permissible tightening torques:

M4	0,8 Nm
M5	1,5 Nm
M8	4 Nm
M12	10 Nm
M18	20 Nm
M30	40 Nm

Flush mounting (b)

In case of flush mounting or parallel mounting the following distances should be observed:

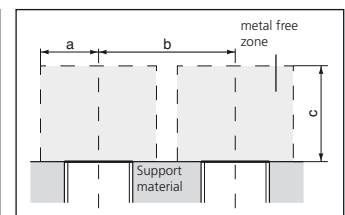

Design	Distance [mm]		
	a	b	c
Ø3	2	3	1,8
M4	2	4	1,8
Ø4	2	4	2,4
□5	3,3	5	2,4
M5	3,3	5	2,4
Ø6,5	5	9,5	4,5
□8	5,5	10	4,5
M8	5,5	10	4,5
M12	6	12	6
M18	14	32	15
M30	25	60	30
DCCR 44 K 20	30	80	40
DCCR 40	30	80	40

Non-flush mounting (nb)

In case of non-flush mounting or parallel mounting the following distances should be observed:

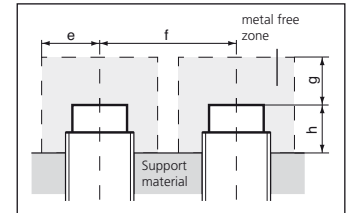

Design	Distance [mm]			
	e	f	g	h
M8	9	16	7,5	8
M12	12	28	12	6
M18	20	50	24	10
M30	30	75	40	15
DCCR 44	80	160	90	40
DCCR 40	90	180	100	40

Standard meas. plates and factors

Design	Measuring plate [mm]	
	Design	Measuring plate [mm]
Ø3	3x3x1	3x3x1
M4	4x4x1	4x4x1
Ø4	4x4x1	4x4x1
□5	5x5x1	5x5x1
M5	5x5x1	5x5x1
Ø6,5	6,5x6,5x1	6,5x6,5x1
□8	8x8x1	8x8x1
M8	8x8x1	8x8x1
M12	12x12x1	12x12x1
M18 b	18x18x1	18x18x1
M18 nb	24x24x1	24x24x1
M30 b	30x30x1	30x30x1
M30 nb	45x45x1	45x45x1
DCCR 44 b	45x45x1	45x45x1
DCCR 44 nb	105x105x1	105x105x1
DCCR 44 K 20	60x60x1	60x60x1

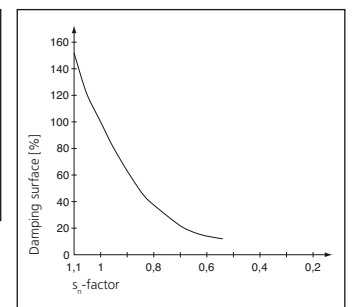

Geometric influence

When using foils, a decrease in the usable operating distance can be expected.

Induktive Näherungsschalter | Inductive proximity switches

Reduktionsfaktor Reduction factor					
	Schaltabstand / Operating distance (mm)				
Materialeinfluss Messplatte Material influence meas. plate	Stahl FE 360 Steel FE 360	Edelstahl Stainless steel	Messing Brass	Aluminium Aluminium	Kupfer Copper
Typ / Model					
DCC 3.0 V 0.6 ... DCC 04 M 0.6 ...	1,0	0,80	0,65	0,55	0,50
DCC 4.0 V 0.8 ... DCC 05 M 0.8 ...	1,0	0,8	0,55	0,50	0,45
DCCQ 05 M 0.8 ...	1,0	0,85	0,70	0,60	0,6
DCCK 6.5 V 1.5 ... DCCK 08 M 1.5 ...	1,0	0,80	0,50	0,45	0,40
DCC 6.5 V 1.5 ... DCC 8.0 V 1.5 ... DCC 08 M 1.5 ... DCC 08 M 2.5 ... DCC 08 V 2.5 ...	1,0	0,70	0,35	0,25	0,20
DCCQ 08 M 1.5 ...	1,0	0,80	0,55	0,50	0,50
DCC 12 M 02 ... DCCK 12 M 02 ...	1,0	0,60	0,50	0,40	0,30
DCC 12 M 04 ... DCCK 12 M 04 ...	1,0	0,90	0,60	0,50	0,50
DCC 18 M 05 ... DCCK 18 M 05 ...	1,0	0,80	0,50	0,40	0,40
DCC 18 M 08 ... DCCK 18 M 08 ...	1,0	0,80	0,50	0,50	0,40
DCC 30 M 10 ... DCCK 30 M 10 ...	1,0	0,70	0,40	0,40	0,30
DCC 30 M 15 ... DCCK 30 M 15 ...	1,0	0,75	0,50	0,40	0,40
DCCR 44 K 15 ... DCCR 44 K 35 ...	1,0	0,85	0,25	0,20	0,10
DCCR 44 K 20 ...	1,0	0,70	0,30	0,30	0,30

Einbauhinweise ②

Maximale Einschraubängen

Durch die in DIN 13 festgelegten Gewindedemaße und Toleranzen ergeben sich folgende maximale Einschraubängen:

M5	5 mm
M8	8 mm
M12	8 mm
M18	8 mm
M30	16 mm

Längere Gewinde sind entsprechend freizubohren.

Leitungsführung

Um eine sichere und zuverlässige Funktion zu gewährleisten, muss Folgendes beachtet werden:

- Anschlussleitungen der Näherungsschalter nicht zusammen mit Leitungen höherer Spannungen oder mit Anschlussleitungen hoher induktiver Lasten (Schütze, Ventile usw.) verlegen. Sicherheitsabstände einhalten.
- Auf der Versorgungsspannung dürfen keine Spannungsspitzen auftreten. Nicht geregelte Spannungsversorgungen mit einem Kondensator puffern.

Anzugsmomente

Durch zu hohe Anzugsmomente der Muttern können Näherungsschalter beschädigt werden.

Die maximal zulässigen Anzugsmomente beachten:

M5	1,5 Nm
M8	4 Nm
M12	10 Nm
M18	25 Nm
M30	70 Nm

Bündiger Einbau (b)

Bei bündigem Einbau bzw. bei Parallelmontage sind folgende Abstände einzuhalten:

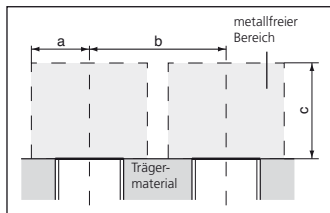

Bauform	Abstand [mm]		
	a	b	c
M5	4,5	10	7,5

Quasi bündiger Einbau (qb)

Bei quasi bündigem Einbau bzw. bei Parallelmontage sind folgende Abstände einzuhalten:

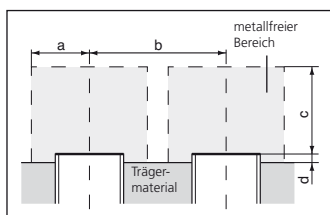

Bauform	Abstand [mm]			
	a	b	c	d
Ø6,5	6	16	9	1
□8	6	16	9	1
M5	6	16	9	1
M8	12	30	18	2
M12	12	30	18	2
M18	18	44	36	4
M30	37	80	66	6

Nichtbündiger Einbau (nb)

Bei nicht bündigem Einbau bzw. bei Parallelmontage sind folgende Abstände einzuhalten.

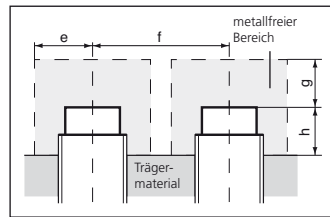

Bauform	Abstand [mm]			
	e	f	g	h
M8	12	28	18	8
M12	16	42	30	10
M18	30	78	60	20
M30	55	150	120	20

Maßx in Aluminium	25
Maßx in Stahl	35
Maßx in Messing	25
Maßx in Edelstahl	20

Normmessplatten und Faktoren

Bauform	Normmessplatte [mm]
M5 b	7,5x7,5x1
Ø6,5 qb	9x9x1
□8 qb	9x9x1
M8 qb	9x9x1
M8 nb	18x18x1
M12 qb	18x18x1
M12 nb	30x30x1
M18 qb	36x36x1
M18 nb	60x60x1
M30 qb	66x66x1
M30 nb	120x120x1

Geometrieinfluss

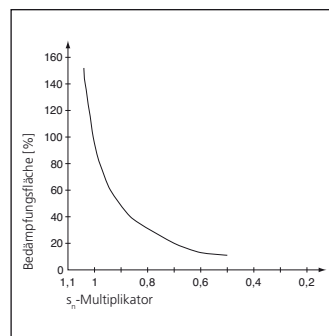

Bei Folien ist eine Verringerung des Schaltabstandes zu erwarten.

Installation notes ②

Maximum screw-in length

Due to the thread dimensions and tolerances stipulated in DIN 13, the following maximum screw-in lengths are valid:

M5	5 mm
M8	8 mm
M12	8 mm
M18	8 mm
M30	16 mm

Clearance drilling is required for longer threads.

Cable routing

To ensure a secure and reliable function, the following must be taken into account:

- Do not route the connection cables of the proximity switches together with higher voltage cables or with connection cables of higher inductive loads (contactors, valves, etc.) maintain safety distances.
- No peaks may occur in the power supply. Use a capacitor to buffer uncontrolled power supplies.

Tightening torque

Proximity switches can be damaged by an excessive tightening torque of the nuts. Please note the maximum permissible tightening torques:

M5	1,5 Nm
M8	4 Nm
M12	10 Nm
M18	25 Nm
M30	70 Nm

Flush mounting (b)

In case of flush mounting or parallel mounting the following distances should be observed:

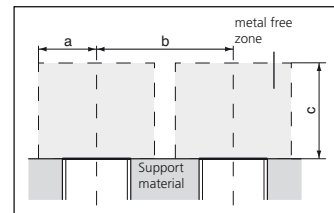

Design	Distance [mm]		
	a	b	c
M5	4,5	10	7,5

Quasi-flush mounting (qb)

In case of quasi-flush mounting or parallel mounting the following distances should be observed:

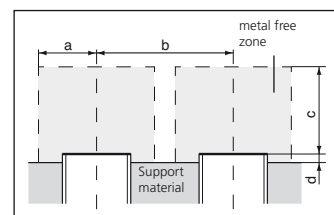

Design	Distance [mm]			
	a	b	c	d
Ø6,5	6	16	9	1
□8	6	16	9	1
M8	6	16	9	1
M12	12	30	18	2
M18	18	44	36	4
M30	37	80	66	6

Non-flush mounting (nb)

In case of non-flush mounting or parallel mounting the following distances should be observed:

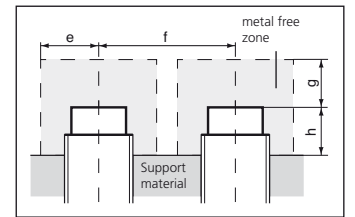

Design	Distance [mm]			
	e	f	g	h
M8	12	28	18	8
M12	16	42	30	10
M18	30	78	60	20
M30	55	150	120	20

Dim. x in aluminium	25
Dim. x in steel	35
Dim. x in brass	25
Dim. x in stainless steel	20

Standard measuring plates and factors

Design	Measuring plate [mm]
M5 b	7,5x7,5x1
Ø6,5 qb	9x9x1
□8 qb	9x9x1
M8 qb	9x9x1
M8 nb	18x18x1
M12 qb	18x18x1
M12 nb	30x30x1
M18 qb	36x36x1
M18 nb	60x60x1
M30 qb	66x66x1
M30 nb	120x120x1

Geometric influence

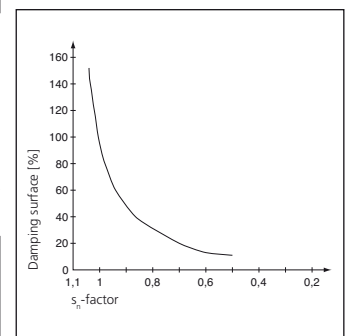

When using foils, a decrease in the usable operating distance can be expected.

Induktive Näherungsschalter | Inductive proximity switches

Reduktionsfaktor Reduction factor					
	Schaltabstand / Operating distance (mm)				
Materialeinfluss Messplatte Material influence meas. plate	Stahl FE 360 Steel FE 360	Edelstahl Stainless steel	Messing Brass	Aluminium Aluminium	Kupfer Copper
Typ / Model					
DCC 05 M 2,5 ...	1,0	0,95	0,37	0,30	0,27
DCC 6.5 M 03 ...	1,0	0,67	0,35	0,26	0,18
DCC 08 M 03 ... DCCQ 08 M 03 ...	1,0	0,77	0,45	0,36	0,27
DCC 12 M 06 ... DCCK 12 M 06 ...	1,0	0,47	0,35	0,28	0,20
DCC 18 M12 ... DCCK 18 M12 ...	1,0	0,63	0,33	0,26	0,20
DCC 30 M 22 ... DCCK 30 M 22 ...	1,0	0,66	0,45	0,40	0,35
DCC 08 M 06 ...	1,0	0,75	0,55	0,49	0,44
DCC 12 M 10 ... DCCK 12 M 10 ...	1,0	0,47	0,52	0,46	0,41
DCC 18 M 20 ... DCCK 18 M 20 ...	1,0	0,66	0,45	0,40	0,35
DCC 30 M 40 ... DCCK 30 M 40 ...	1,0	0,78	0,47	0,42	0,37

Einbauhinweise ③

Maximale Einschraubängen

Durch die in DIN 13 festgelegten Gewindedemaße und Toleranzen ergeben sich folgende maximale Einschraubängen:

M8	8 mm
M12	8 mm
M18	8 mm
M30	16 mm

Längere Gewinde sind entsprechend freizubohren.

Leitungsführung

Um eine sichere und zuverlässige Funktion zu gewährleisten, muss Folgendes beachtet werden:

- Anschlussleitungen der Näherungsschalter nicht zusammen mit Leitungen höherer Spannungen oder mit Anschlussleitungen hoher induktiver Lasten (Schütze, Ventile usw.) verlegen. Sicherheitsabstände einhalten.
- Auf der Versorgungsspannung dürfen keine Spannungsspitzen auftreten. Nicht geregelte Spannungsversorgungen mit einem Kondensator puffern.

Anzugsmomente

Durch zu hohe Anzugsmomente der Muttern können Näherungsschalter beschädigt werden.

Die maximal zulässigen Anzugsmomente beachten:

M4	0,8 Nm
M5	1,5 Nm
M8	4 Nm
M12	10 Nm
M18	20 Nm

Bündiger Einbau (b)

Bei bündigem Einbau bzw. bei Parallelmontage sind folgende Abstände einzuhalten:

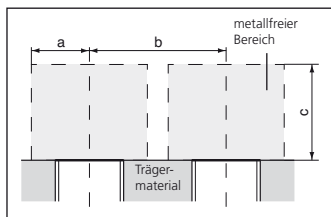

Bauform

Abstand [mm]

Bauform	Abstand [mm]		
	a	b	c
Ø3	2,5	5	3
M4	2,5	5	3
Ø4	3,5	5	4,5
□5	4	6	4,5
M5	4	6	4,5
Ø6,5	5	10	6
Ø8	6	15	6
□8	5	10	6
M8	5	10	6
M12	10	24	12

Quasi bündiger Einbau (qb)

Bei quasi bündigem Einbau bzw. bei Parallelmontage sind folgende Abstände einzuhalten:

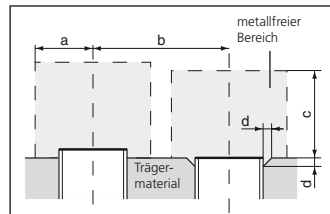

Bauform

Abstand [mm]

Bauform	Abstand [mm]			
	a	b	c	d
M18	18	40	24	1,5

Normmessplatten und Faktoren

Bauform

Normmessplatte [mm]

Ø3	3x3x1
M4	4x4x1
Ø4	4,5x4,5x1
□5	5x5x1
M5	5x5x1
Ø6,5	6,5x6,5x1
□8	8x8x1
M8	8x8x1
M12	12x12x1
M18 qb	24x24x1

Geometrieinfluss

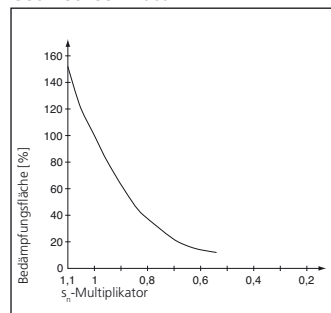

Bei Folien ist eine Verringerung des Schaltabstandes zu erwarten.

Installation notes ③

Maximum screw-in length

Due to the thread dimensions and tolerances stipulated in DIN 13, the following maximum screw-in lengths are valid:

M8	8 mm
M12	8 mm
M18	8 mm
M30	16 mm

Clearance drilling is required for longer threads.

Cable routing

To ensure a secure and reliable function, the following must be taken into account:

- Do not route the connection cables of the proximity switches together with higher voltage cables or with connection cables of higher inductive loads (contactors, valves, etc.) maintain safety distances.
- No peaks may occur in the power supply. Use a capacitor so buffer uncontrolled power supplies.

Tightening torque

Proximity switches can be damaged by an excessive tightening torque of the nuts. Please note the maximum permissible tightening torques:

M4	0,8 Nm
M5	1,5 Nm
M8	4 Nm
M12	10 Nm
M18	20 Nm

Flush mounting (b)

In case of flush mounting or parallel mounting the following distances should be observed:

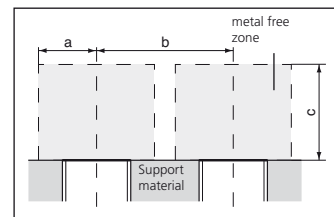

When using foils, a decrease in the usable operating distance can be expected.

Design

Distance [mm]

Design	Distance [mm]		
	a	b	c
Ø3	2,5	5	3
M4	2,5	5	3
Ø4	3,5	5	4,5
□5	4	6	4,5
M5	4	6	4,5
Ø6,5	5	10	6
Ø8	6	15	6
□8	5	10	6
M8	5	10	6
M12	16	14	8

Quasi-flush mounting (qb)

In case of quasi-flush mounting or parallel mounting the following distances should be observed:

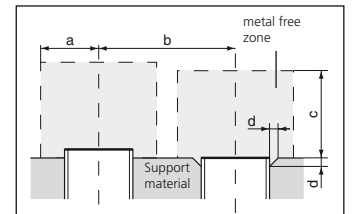

Design

Distance [mm]

Design	Distance [mm]			
	a	b	c	d
M18	18	40	24	1,5

Standard measuring plates and factors

Design

Measuring plate [mm]

Ø3	3x3x1
M4	4x4x1
Ø4	4,5x4,5x1
□5	5x5x1
M5	5x5x1
Ø6,5	6,5x6,5x1
□8 / M8	8x8x1
M12	12x12x1
M18 qb	24x24x1

Geometric influence

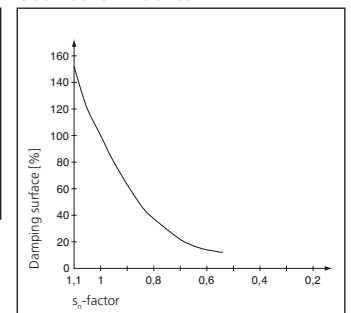

Reduktionsfaktor Reduction factor		Schaltabstand / Operating distance (mm)							
		Ø3	Ø4	□5	Ø6,5	Ø8	□8	M12	M18
Materialeinfluss Messplatte	Material influence meas. plate								
Stahl FE 360	Steel FE 360	1,00	1,00	1,00	1,00	1,00	1,00	1,00	1,00
Edelstahl	Stainless steel	0,80	0,75	0,85	0,70	0,80	0,80	0,80	0,70
Messing	Brass	0,60	0,50	0,70	0,40	0,55	0,50	0,50	0,50
Aluminium	Aluminium	0,50	0,40	0,60	0,30	0,50	0,40	0,40	0,40
Kupfer	Copper	0,45	0,40	0,60	0,25	0,50	0,40	0,40	0,30

Induktive Näherungsschalter | Inductive proximity switches

Einbauhinweise ④

Maximale Einschraublängen

Durch die in DIN 13 festgelegten Gewindedemaße und Toleranzen ergeben sich folgende maximale Einschraublängen:

M8	8 mm
M12	8 mm
M18	8 mm

Längere Gewinde sind entsprechend freizubohren.

Leitungsführung

Um eine sichere und zuverlässige Funktion zu gewährleisten, muss Folgendes beachtet werden:

- Anschlussleitungen der Näherungsschalter nicht zusammen mit Leitungen höherer Spannungen oder mit Anschlussleitungen hoher induktiver Lasten (Schütze, Ventile usw.) verlegen. Sicherheitsabstände einhalten.
- Auf der Versorgungsspannung dürfen keine Spannungsspitzen auftreten. Nicht geregelte Spannungsversorgungen mit einem Kondensator puffern.

Anzugsmomente

Durch zu hohe Anzugsmomente der Muttern können Näherungsschalter beschädigt werden. Die maximal zulässigen Anzugsmomente beachten:

M8	2,5 Nm
M12	10 Nm
M18	20 Nm

Bündiger Einbau (b)

Bei bündigem Einbau bzw. bei Parallelmontage sind folgende Abstände einzuhalten:

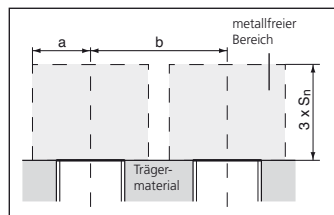

Bauform	Abstand [mm]	
	a	b
□ 8	12	16
M8	12	16
□ 12	18	30
M12	18	30
M18	30	60
28x16x10 mm	15	20
40x26x12 mm	18	24

Nichtbündiger Einbau (nb)

Bei nicht bündigem Einbau bzw. bei Parallelmontage sind folgende Abstände einzuhalten:

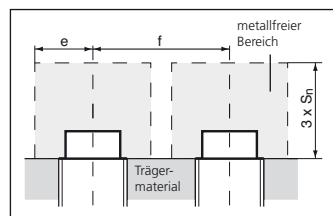

Bauform	Abstand [mm]	
	e	f
M8	12	28
M12	18	36
M18	30	46
40x26x12 mm	18	24

Normmessplatten und Faktoren

Bauform	Normmessplatte [mm]
□ 8	8x8x1
M8	8x8x1
□ 12	12x12x1
M12	12x12x1
M18	18x18x1
28x16x10 mm	10x10x1
40x26x12 mm	10x10x1

Materialeinfluss

Messplatte	Schaltabstand
Stahl ST37	Sn x 1,00
Chrom-Nickel	Sn x 0,90
Edelstahl V2A	Sn x 0,85
Messing	Sn x 0,50
Aluminium	Sn x 0,45
Kupfer	Sn x 0,40

Installation notes ④

Maximum screw-in length

Due to the thread dimensions and tolerances stipulated in DIN 13, the following maximum screw-in lengths are valid:

M8	8 mm
M12	8 mm
M18	8 mm

Clearance drilling is required for longer threads.

Cable routing

To ensure a secure and reliable function, the following must be taken into account:

- Do not route the connection cables of the proximity switches together with higher voltage cables or with connection cables of higher inductive loads (contactors, valves, etc.) maintain safety distances.
- No peaks may occur in the power supply. Use a capacitor to buffer uncontrolled power supplies.

Tightening torque

Proximity switches can be damaged by an excessive tightening torque of the nuts. Please note the maximum permissible tightening torques:

M8	2,5 Nm
M12	10 Nm
M18	20 Nm

Flush mounting (b)

In case of flush mounting or parallel mounting the following distances should be observed:

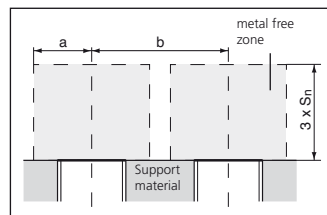

Design	Dimension [mm]	
	a	b
□ 8	12	16
M8	12	16
□ 12	18	30
M12	18	30
M18	30	60
28x16x10 mm	15	20
40x26x12 mm	18	24

Non-flush mounting (nb)

In case of non-flush mounting or parallel mounting the following distances should be observed:

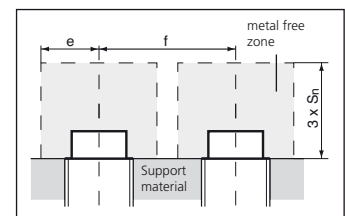

Design	Distance [mm]	
	e	f
M8	12	28
M12	18	36
M18	30	46
40x26x12 mm	18	24

Standard measuring plates and factors

Design	Measuring plate [mm]
□ 8	8x8x1
M8	8x8x1
□ 12	12x12x1
M12	12x12x1
M18	18x18x1
28x16x10 mm	10x10x1
40x26x12 mm	10x10x1

Material influence meas. plate

Material	Operating distance
Steel ST37	Sn x 1,00
Chromium-Nickel	Sn x 0,90
Stainless steel V2A	Sn x 0,85
Brass	Sn x 0,50
Aluminium	Sn x 0,45
Copper	Sn x 0,40

Einbauhinweise ⑤

Maximale Einschraub­längen

Durch die in DIN 13 festgelegten Gewindemaße und Toleranzen ergeben sich folgende maximale Einschraub­längen:

M8	8 mm
M12	8 mm
M18	8 mm
M30	16 mm

Längere Gewinde sind entsprechend freizubohren.

Leitungsführung

Um eine sichere und zuverlässige Funktion zu gewährleisten, muss Folgendes beachtet werden:

- Anschlussleitungen der Näherungsschalter nicht zusammen mit Leitungen höherer Spannungen oder mit Anschlussleitungen hoher induktiver Lasten (Schütze, Ventile usw.) verlegen. Sicherheitsabstände einhalten.
- Auf der Versorgungsspannung dürfen keine Spannungsspitzen auftreten. Nicht geregelte Spannungsversorgungen mit einem Kondensator puffern.

Anzugsmomente

Durch zu hohe Anzugsmomente der Muttern können Näherungsschalter beschädigt werden.

Die maximal zulässigen Anzugsmomente beachten:

M8	10 Nm
M12	20 Nm
M18	50 Nm
M30	150 Nm

Bündiger Einbau (b)

Bei bündigem Einbau bzw. bei Parallelmontage sind folgende Abstände einzuhalten:

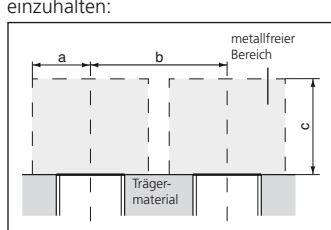

Bauform	Abstand [mm]		
	a	b	c
M8	6	22	9
M12	12	40	18
M18	25	60	30
M30	45	90	60

Nichtbündiger Einbau (nb)

Bei nicht bündigem Einbau bzw. bei Parallelmontage sind folgende Abstände einzuhalten:

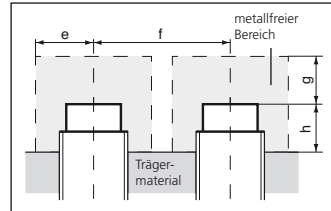

Abstand [mm]	Bauform			
	M8	M12	M18	M30
e	18	30	50	90
f	60	80	150	250
g	18	30	60	120
h (Aluminium)	9	13	20	30
h (Messing)	10	15	22	40
h (Stahl)	15	20	35	60
h (Edelstahl)	14	20	35	60

Normmessplatten und Faktoren

Bedingt durch das neuartige Funktionsprinzip ist der erzielbare Schaltabstand abhängig von der Fläche und Dicke der Betätigungsfahne und von deren spezifischem Widerstand. Dadurch ergeben sich folgende Verhältnisse:

Bauform	Normmessplatte [mm]
M 8 b	9x9x1
M 8 nb	18x18x1
M12 b	18x18x1
M12 nb	30x30x1
M18 b	30x30x1
M18 nb	60x60x1
M30 b	60x60x1
M30 nb	120x120x1

Geometrie­einfluss

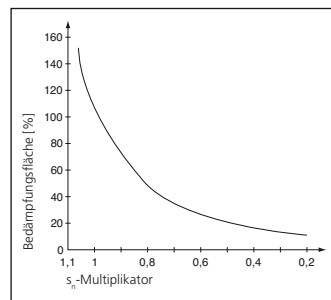

Bei Folien ist eine Verringerung des Schaltabstandes zu erwarten.

Installation notes ⑤

Maximum screw-in length

Due to the thread dimensions and tolerances stipulated in DIN 13, the following maximum screw-in lengths are valid:

M8	8 mm
M12	8 mm
M18	8 mm
M30	16 mm

Clearance drilling is required for longer threads.

Cable routing

To ensure a secure and reliable function, the following must be taken into account:

- Do not route the connection cables of the proximity switches together with higher voltage cables or with connection cables of higher inductive loads (contactors, valves, etc.) maintain safety distances.
- No peaks may occur in the power supply. Use a capacitor to buffer uncontrolled power supplies.

Tightening torque

Proximity switches can be damaged by an excessive tightening torque of the nuts. Please note the maximum permissible tightening torques.

M8	10 Nm
M12	20 Nm
M18	50 Nm
M30	150 Nm

Flush mounting (b)

In case of flush mounting or parallel mounting the following distances should be observed:

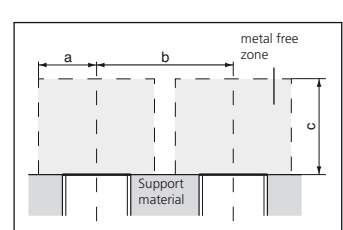

Design	Distance [mm]		
	a	b	c
M8	6	22	9
M12	12	40	18
M18	25	60	30
M30	45	90	60

Non-flush mounting (nb)

In case of non-flush mounting or parallel mounting the following distances should be observed:

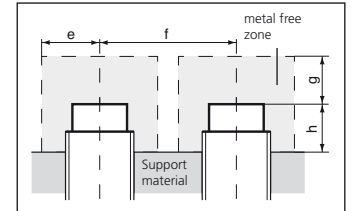

Distance [mm]	Design			
	M8	M12	M18	M30
e	18	30	50	90
f	60	80	150	250
g	18	30	60	120
h (aluminium)	9	13	20	30
h (brass)	10	15	22	40
h (steel)	15	20	35	60
h (stainless steel)	14	20	35	60

Standard measuring plates and factors

Due to the new operation principle the attainable operation distance depends on the square dimension and thickness of the actuation object and on its specific resistance. Thus the following conditions result:

Design	Meas. plate [mm]
M 8 b	9x9x1
M 8 nb	18x18x1
M12 b	18x18x1
M12 nb	30x30x1
M18 b	30x30x1
M18 nb	60x60x1
M30 b	60x60x1
M30 nb	120x120x1

Geometric influence

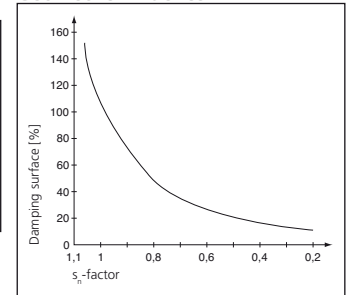

When using foils, a decrease in the usable operating distance can be expected.

Reduktionsfaktor Reduction factor		Schaltabstand / Operating distance (mm)							
Materialeinfluss Messplatte Material influence meas. plate		M8 b	M8 nb	M12 b	M12 nb	M18 b	M18 nb	M30 b	M30 nb
Stahl FE 360 Steel FE 360		1,00	1,00	1,00	1,00	1,00	1,00	1,00	1,00
Messing Brass		1,35	1,40	1,30	1,40	1,35	1,30	1,20	1,20
Aluminium Aluminium		1,00	1,00	1,00	1,00	1,00	1,00	1,00	1,00
Kupfer Copper		0,90	0,85	0,85	0,80	0,85	0,90	0,90	0,90
Edelstahl (1 mm) Stainless steel (1 mm)		0,30	0,30	0,45	0,00	0,40	0,30	0,50	-
Edelstahl (2 mm) Stainless steel (2 mm)		0,60	0,90	0,90	0,65	0,80	0,60	0,90	0,25

Induktive Näherungsschalter | Inductive proximity switches

Einbauhinweise ⑥

Maximale Einschraub­längen

Durch die in DIN 13 festgelegten Gewindemaße und Toleranzen ergeben sich folgende maximale Einschraub­längen:

M5	5 mm
M8	8 mm

Längere Gewinde sind entsprechend freizubohren.

Leitungsführung

Um eine sichere und zuverlässige Funktion zu gewährleisten, muss Folgendes beachtet werden:

- Anschlussleitungen der Näherungsschalter nicht zusammen mit Leitungen höherer Spannungen oder mit Anschlussleitungen hoher induktiver Lasten (Schütze, Ventile usw.) verlegen. Sicherheitsabstände einhalten.
- Auf der Versorgungsspannung dürfen keine Spannungsspitzen auftreten. Nicht geregelte Spannungsversorgungen mit einem Kondensator puffern.

Anzugsmomente

Durch zu hohe Anzugsmomente der Muttern können Näherungsschalter beschädigt werden. Die maximal zulässigen Anzugsmomente beachten:

M5	1,5 Nm
M8	4 Nm

Bündiger Einbau (b)

Bei bündigem Einbau bzw. bei Parallelmontage sind folgende Abstände einzuhalten:

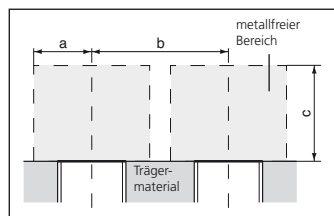

Bauform	Abstand [mm]		
	a	b	c
Ø4	2	4	2
M5	2	5	2
Ø6,5	6	16	9
M8	6	16	9

Normmessplatten und Faktoren

Bauform	Normmessplatte [mm]
Ø4	4x4x1
M5	5x5x1
Ø6,5	7,5x7,5x1
M8	7,5x7,5x1

Materialeinfluss

Messplatte	Schaltabstand
Stahl FE 360	Sn x 1,00
Edelstahl V2A	Sn x 0,60
Messing	Sn x 0,25
Aluminium	Sn x 0,20
Kupfer	Sn x 0,15

Geometrieinfluss

Bauform Ø4 und M5

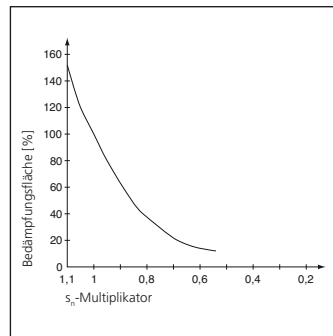

Bauform Ø6,5 und M8

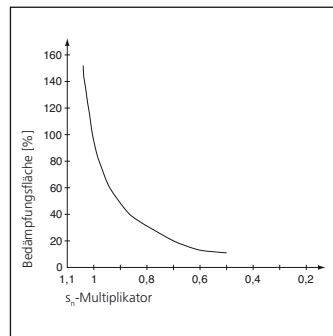

Bei Folien ist eine Verringerung des Schaltabstandes zu erwarten.

Installation notes ⑥

Maximum screw-in length

Due to the thread dimensions and tolerances stipulated in DIN 13, the following maximum screw-in lengths are valid:

M5	5 mm
M8	8 mm

Clearance drilling is required for longer threads.

Cable routing

To ensure a secure and reliable function, the following must be taken into account:

- Do not route the connection cables of the proximity switches together with higher voltage cables or with connection cables of higher inductive loads (contactors, valves, etc.) maintain safety distances.
- No peaks may occur in the power supply. Use a capacitor to buffer uncontrolled power supplies.

Tightening torque

Proximity switches can be damaged by an excessive tightening torque of the nuts. Please note the maximum permissible tightening torques:

M5	1,5 Nm
M8	4 Nm

Flush mounting (b)

In case of flush mounting or parallel mounting the following distances should be observed:

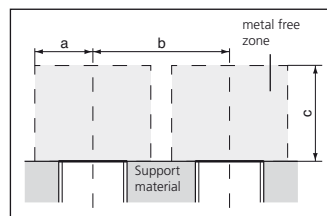

Design	Distance [mm]		
	a	b	c
Ø4	2	4	2
M5	2	5	2
Ø6,5	6	16	9
M8	6	16	9

Standard measuring plates and factors

Design	Measuring plate [mm]
Ø4	4x4x1
M5	5x5x1
Ø6,5	7,5x7,5x1
M8	7,5x7,5x1

Material influence meas. plate

Material	Operating distance
Steel FE 360	Sn x 1,00
Stainless steel V2A	Sn x 0,60
Brass	Sn x 0,25
Aluminium	Sn x 0,20
Copper	Sn x 0,15

Geometric influence

Design Ø4 and M5

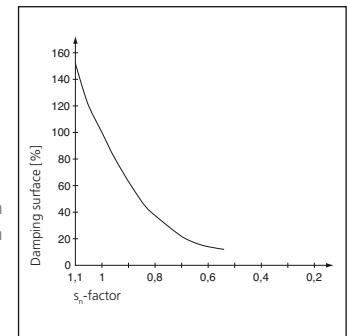

Design Ø6,5 and M8

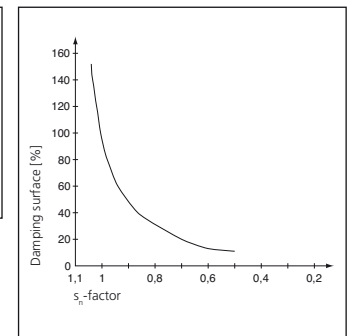

When using foils, a decrease in the usable operating distance can be expected.

Einbauhinweise ⑦

Leitungsführung

Um eine sichere und zuverlässige Funktion zu gewährleisten, muss Folgendes beachtet werden:

- Anschlussleitungen der Näherungsschalter nicht zusammen mit Leitungen höherer Spannungen oder mit Anschlussleitungen hoher induktiver Lasten (Schütze, Ventile usw.) verlegen. Sicherheitsabstände einhalten.
- Auf der Versorgungsspannung dürfen keine Spannungsspitzen auftreten. Nicht geregelte Spannungsversorgungen mit einem Kondensator puffern.

Normmessplatten und Faktoren

Bauform	Normmessplatte [mm]
M12	10x10x1
M18	15x15x1

Geometrieinfluss

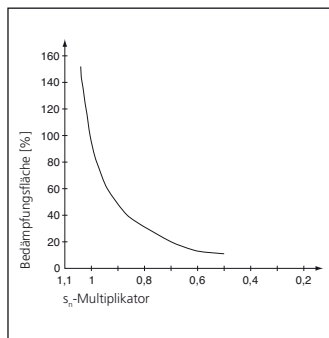

Bei Folien ist eine Verringerung des Schaltabstandes zu erwarten.

Installation notes ⑦

Cable routing

To ensure a secure and reliable function, the following must be taken into account:

- Do not route the connection cables of the proximity switches together with higher voltage cables or with connection cables of higher inductive loads (contactors, valves, etc.) maintain safety distances.
- No peaks may occur in the power supply. Use a capacitor to buffer uncontrolled power supplies.

Standard measuring plates and factors

Design	Measuring plate [mm]
M12	10x10x1
M18	15x15x1

Geometric influence

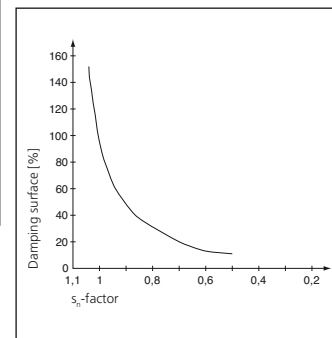

When using foils, a decrease in the usable operating distance can be expected.

Ansprechkurve M12

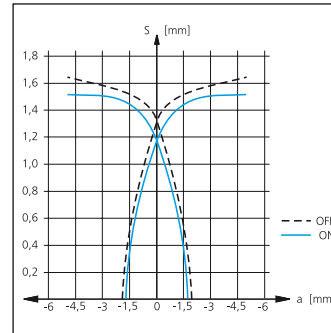

Response diagram M12

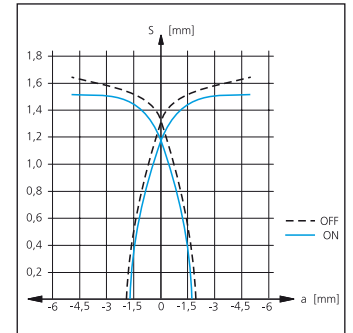

Ansprechkurve M18

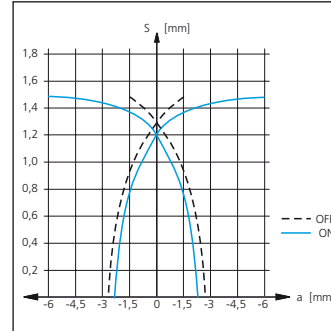

Response diagram M18

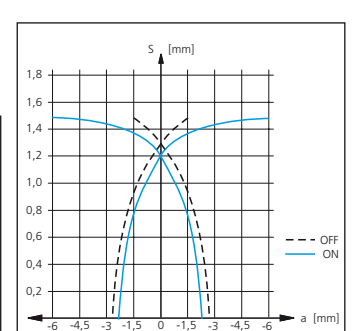

Einbauzeichnung M12 und M18 / Installation drawing M12 and M18

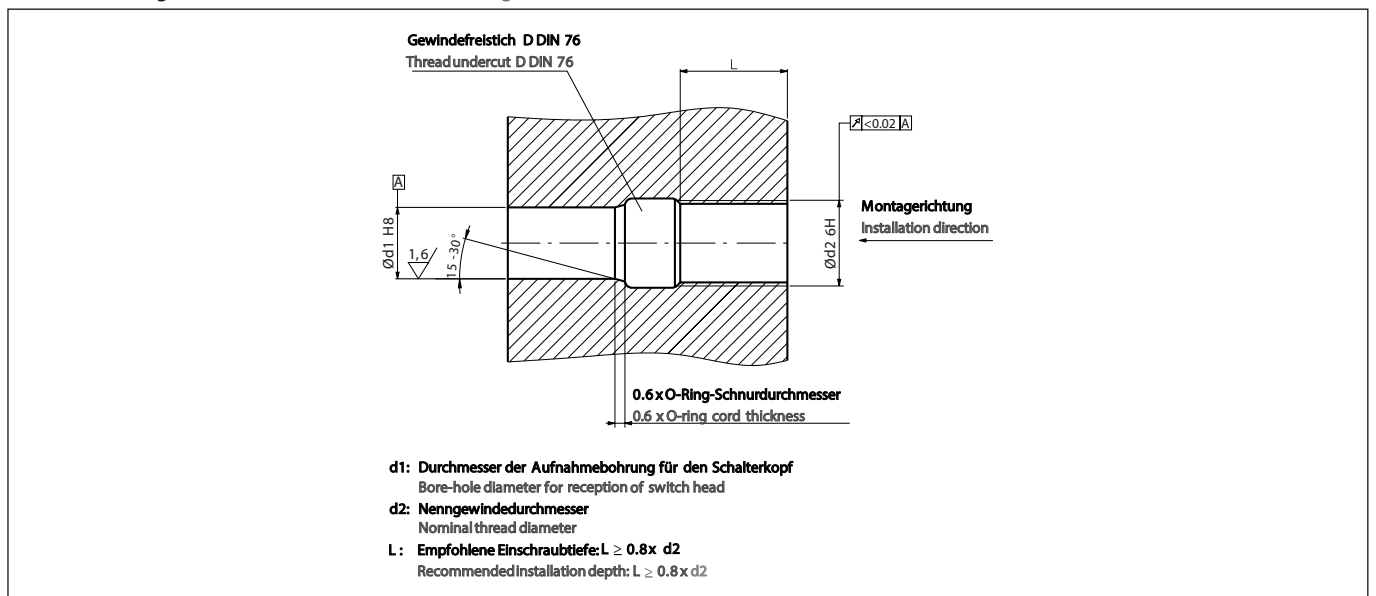

Induktive Näherungsschalter | Inductive proximity switches

Einbauhinweise ⑧

Maximale Einschraublängen

Durch die in DIN 13 festgelegten Gewindemaße und Toleranzen ergeben sich folgende maximale Einschraublängen:

M12	8 mm
M18	8 mm
M30	16 mm

Längere Gewinde sind entsprechend freizubohren.

Leitungsführung

Um eine sichere und zuverlässige Funktion zu gewährleisten, muss Folgendes beachtet werden:

- Anschlussleitungen der Näherungsschalter nicht zusammen mit Leitungen höherer Spannungen oder mit Anschlussleitungen hoher induktiver Lasten (Schütze, Ventile usw.) verlegen. Sicherheitsabstände einhalten.
- Auf der Versorgungsspannung dürfen keine Spannungsspitzen auftreten. Nicht geregelte Spannungsversorgungen mit einem Kondensator puffern.

Anzugsmomente

Durch zu hohe Anzugsmomente der Muttern können Näherungsschalter beschädigt werden. Die maximal zulässigen Anzugsmomente beachten:

M12	10 Nm
M18	36 Nm
M30	200 Nm

Bündiger Einbau (b)

Bei bündigem Einbau bzw. bei Parallelmontage sind folgende Abstände einzuhalten:

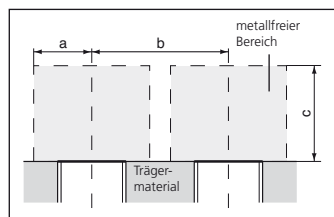

Bauform	Abstand [mm]		
	a	b	c
M12	18	24	6
M18	27	36	15
M30	45	60	30

Nichtbündiger Einbau (nb)

Bei nicht bündigem Einbau bzw. bei Parallelmontage sind folgende Abstände einzuhalten:

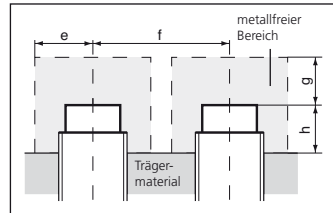

Bauform	Abstand [mm]			
	e	f	g	h
M12	18	24	12	8
M18	27	39	21	14

Normmessplatten und Faktoren

Bauform	Normmessplatte [mm]
M12	12x12x1
M18 b	18x18x1
M18 nb	21x21x1
M30	30x30x1

Materialeinfluss

Messplatte	Schaltabstand
Stahl ST37	Sn x 1,00
Edelstahl V2A	Sn x 0,70
Messing	Sn x 0,50
Aluminium	Sn x 0,45
Kupfer	Sn x 0,40

Geometrieinfluss

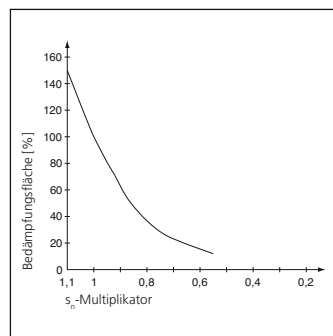

Installation notes ⑧

Maximum screw-in length

Due to the thread dimensions and tolerances stipulated in DIN 13, the following maximum screw-in lengths are valid:

M12	8 mm
M18	8 mm
M30	16 mm

Clearance drilling is required for longer threads.

Cable routing

To ensure a secure and reliable function, the following must be taken into account:

- Do not route the connection cables of the proximity switches together with higher voltage cables or with connection cables of higher inductive loads (contactors, valves, etc.) maintain safety distances.
- No peaks may occur in the power supply. Use a capacitor to buffer uncontrolled power supplies.

Tightening torque

Proximity switches can be damaged by an excessive tightening torque of the nuts. Please note the maximum permissible tightening torques:

M12	10 Nm
M18	36 Nm
M30	200 Nm

Flush mounting (b)

In case of flush mounting or parallel mounting the following distances should be observed:

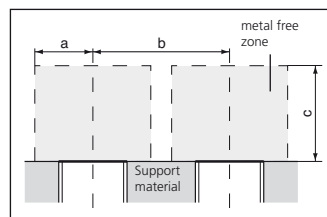

Design	Distance [mm]		
	a	b	c
M12	18	24	6
M18	27	36	15
M30	45	60	30

Non-flush mounting (nb)

In case of non-flush mounting or parallel mounting the following distances should be observed:

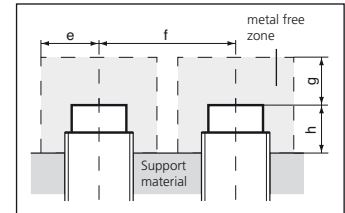

Design	Distance [mm]			
	e	f	g	h
M12	18	24	12	8
M18	27	39	21	14

Standard measuring plates and factors

Design	Meas. plate [mm]
M12	12x12x1
M18 b	18x18x1
M18 nb	21x21x1
M30	30x30x1

Material influence

meas. plate	Operating distance
Steel ST37	Sn x 1,00
Stainless steel V2A	Sn x 0,70
Brass	Sn x 0,50
Aluminium	Sn x 0,45
Copper	Sn x 0,40

Geometric influence

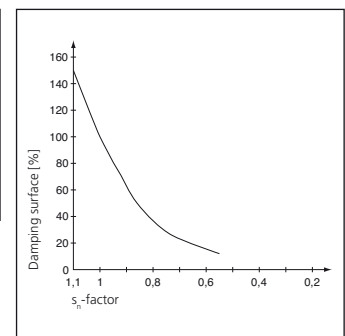

Einbauhinweise ⑨

Maximale Einschraubängen

Durch die in DIN 13 festgelegten Gewindedemaße und Toleranzen ergeben sich folgende maximale Einschraubängen:

M8	8 mm
M12	8 mm
M18	8 mm
M30	16 mm

Längere Gewinde sind entsprechend freizubohren.

Leitungsführung

Um eine sichere und zuverlässige Funktion zu gewährleisten, muss Folgendes beachtet werden:

- Anschlussleitungen der Näherungsschalter nicht zusammen mit Leitungen höherer Spannungen oder mit Anschlussleitungen hoher induktiver Lasten (Schütze, Ventile usw.) verlegen. Sicherheitsabstände einhalten.
- Auf der Versorgungsspannung dürfen keine Spannungsspitzen auftreten. Nicht geregelte Spannungsversorgungen mit einem Kondensator puffern.

Anzugsmomente

Durch zu hohe Anzugsmomente der Muttern können Näherungsschalter beschädigt werden.

Die maximal zulässigen Anzugsmomente beachten:

M8	4 Nm
M12	10 Nm
M18	25 Nm
M30	70 Nm

Nichtbündiger Einbau (nb)

Bei nicht bündigem Einbau bzw. bei Parallelmontage sind folgende Abstände einzuhalten:

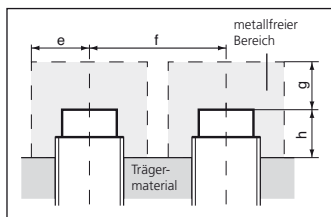

Bauform	Abstand [mm]			
	e	f	g	h
M30	55	150	120	X
				↓
Maß x in Aluminium				25
Maß x in Stahl				35
Maß x in Messing				25
Maß x in Edelstahl				20

Quasi bündiger Einbau (qb)

Bei quasi bündigem Einbau bzw. bei Parallelmontage sind folgende Abstände einzuhalten:

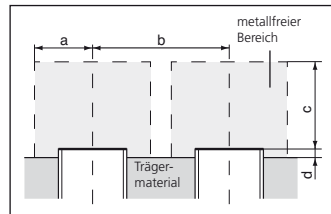

Bauform	Abstand [mm]			
	a	b	c	d
M8	8	20	12	1
M12	12	30	18	2
M18	19	44	30	4
M30	35	80	60	6

Normmessplatten und Faktoren

Bauform	Normmessplatte [mm]
M8 qb / □ 8 qb	12 x 12 x 1
M12 qb	18 x 18 x 1
M18 qb	30 x 30 x 1
M30 qb	60 x 60 x 1
M30 nb	120 x 120 x 1

Geometrieinfluss

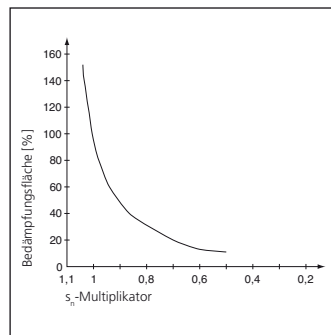

Bei Folien ist eine Verringerung des Schaltabstandes zu erwarten.

Installation notes ⑨

Maximum screw-in length

Due to the thread dimensions and tolerances stipulated in DIN 13, the following maximum screw-in lengths

are valid:

M8	8 mm
M12	8 mm
M18	8 mm
M30	16 mm

Clearance drilling is required for longer threads.

Cable routing

To ensure a secure and reliable function, the following must be taken into account:

- Do not route the connection cables of the proximity switches together with higher voltage cables or with connection cables of higher inductive loads (contactors, valves, etc.) maintain safety distances.
- No peaks may occur in the power supply. Use a capacitor to buffer uncontrolled power supplies.

Tightening torque

Proximity switches can be damaged by an excessive tightening torque of the nuts. Please note the maximum permissible tightening torques:

M8	4 Nm
M12	10 Nm
M18	25 Nm
M30	70 Nm

Non-flush mounting (nb)

In case of non-flush mounting or parallel mounting the following distances should be observed:

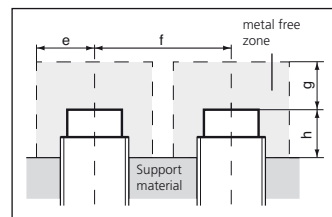

Design	Distance [mm]			
	e	f	g	h
M30	55	150	120	X
				↓
Dim. x in aluminium				25
Dim. x in steel				35
Dim. x in brass				25
Dim. x in stainless steel				20

Quasi-flush mounting (qb)

In case of quasi-flush mounting or parallel mounting the following distances should be observed:

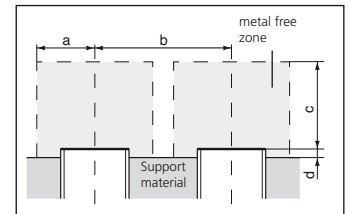

Design	Distance [mm]			
	a	b	c	d
M8	8	20	12	1
M12	12	30	18	2
M18	19	44	30	4
M30	35	80	60	6

Standard measuring plates and factors

Design	Meas. plate [mm]
M8 qb / □ 8 qb	12 x 12 x 1
M12 qb	18 x 18 x 1
M18 qb	30 x 30 x 1
M30 qb	60 x 60 x 1
M30 nb	120 x 120 x 1

Geometric influence

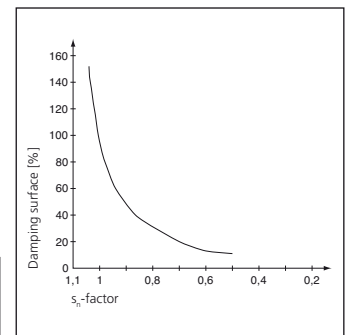

When using foils, a decrease in the usable operating distance can be expected.

Reduktionsfaktor Reduction factor		Schaltabstand / Operating distance (mm)				
Materialeinfluss Messplatte Material influence meas. plate		M8 qb □ 8qb	M12 qb	M18 qb	M30 qb	M30 nb
Stahl FE 360	Steel FE 360	1,00	1,00	1,00	1,00	1,00
Edelstahl	Stainless steel	0,68	0,47	0,60	0,65	0,80
Messing	Brass	0,40	0,35	0,28	0,30	0,50
Aluminium	Aluminium	0,28	0,28	0,18	0,20	0,40
Kupfer	Copper	0,25	0,20	0,15	0,17	0,40

Induktive Näherungsschalter | Inductive proximity switches

Einbauhinweise ^①

Maximale Einschraub­längen

Durch die in DIN 13 festgelegten Gewin­demaße und Toleranzen ergeben sich folgende maximale Einschraub­längen:

M8	8 mm
M12	8 mm

Längere Gewinde sind entsprechend freizubohren.

Leitungsführung

Um eine sichere und zuverlässige Funktion zu gewährleisten, muss Folgendes beachtet werden:

- Anschlussleitungen der Näherungsschalter nicht zusammen mit Leitungen höherer Spannungen oder mit Anschlussleitungen hoher induktiver Lasten (Schütze, Ventile usw.) verlegen. Sicherheitsabstände einhalten.
- Auf der Versorgungsspannung dürfen keine Spannungsspitzen auftreten. Nicht geregelte Spannungsversorgungen mit einem Kondensator puffern.

Anzugsmomente

Durch zu hohe Anzugsmomente der Muttern können Näherungsschalter beschädigt werden.

Die maximal zulässigen Anzugsmomente beachten:

M8	4 Nm
M12	10 Nm

Quasi bündiger Einbau (qb)

Bei quasi bündigem Einbau bzw. bei Parallelmontage sind folgende Abstände einzuhalten:

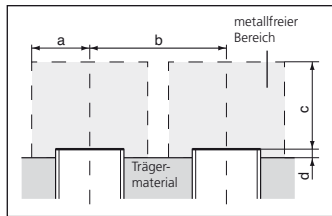

Bauform	Abstand [mm]			
	a	b	c	d
M8	8	24	12	1
M12	14	46	24	2

Normmessplatten und Faktoren

Bauform	Normmessplatte [mm]
M8 qb	16x16x1
M12 qb	32x32x1

Materialeinfluss Messplatte

Messplatte	Schaltabstand
Stahl FE 360	Sn x 1,00
Edelstahl V2A	Sn x 0,65
Messing	Sn x 0,35
Aluminium	Sn x 0,25
Kupfer	Sn x 0,22

Geometrieinfluss

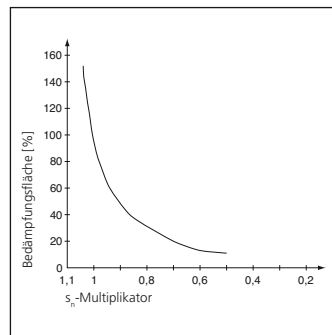

Bei Folien ist eine Verringerung des Schaltabstandes zu erwarten.

Installation notes ^①

Maximum screw-in length

Due to the thread dimensions and tolerances stipulated in DIN 13, the following maximum screw-in lengths are valid:

M8	8 mm
M12	8 mm

Clearance drilling is required for longer threads.

Cable routing

To ensure a secure and reliable function, the following must be taken into account:

- Do not route the connection cables of the proximity switches together with higher voltage cables or with connection cables of higher inductive loads (contactors, valves, etc.) maintain safety distances.
- No peaks may occur in the power supply. Use a capacitor to buffer uncontrolled power supplies.

Tightening torque

Proximity switches can be damaged by an excessive tightening torque of the nuts. Please note the maximum permissible tightening torques:

M8	4 Nm
M12	10 Nm

Quasi-flush mounting (qb)

In case of quasi-flush mounting or parallel mounting the following distances should be observed:

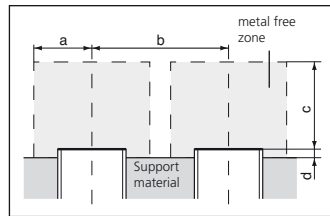

Design	Distance [mm]			
	a	b	c	d
M8	8	24	12	1
M12	14	46	24	2

Standard measuring plates and factors

Design	Measuring plate [mm]
M8 qb	16x16x1
M12 qb	32x32x1

Material influence meas. plate

Material	Operating distance
Steel FE 360	Sn x 1,00
Stainless steel V2A	Sn x 0,65
Brass	Sn x 0,35
Aluminium	Sn x 0,25
Copper	Sn x 0,22

Geometric influence

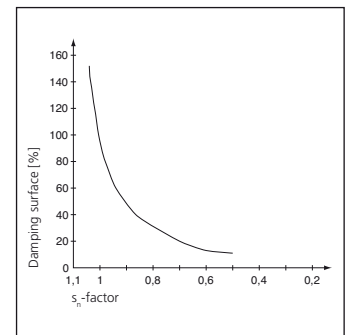

When using foils, a decrease in the usable operating distance can be expected.

Einbauhinweise ¹²

Maximale Einschraublängen

Durch die in DIN 13 festgelegten Gewindedemaße und Toleranzen ergeben sich folgende maximale Einschraublängen:

M12	8 mm
M18	8 mm
M30	16 mm

Längere Gewinde sind entsprechend freizubohren.

Leitungsführung

Um eine sichere und zuverlässige Funktion zu gewährleisten, muss Folgendes beachtet werden:

- Anschlussleitungen der Näherungsschalter nicht zusammen mit Leitungen höherer Spannungen oder mit Anschlussleitungen hoher induktiver Lasten (Schütze, Ventile usw.) verlegen. Sicherheitsabstände einhalten.
- Auf der Versorgungsspannung dürfen keine Spannungsspitzen auftreten. Nicht geregelte Spannungsversorgungen mit einem Kondensator puffern.

Anzugsmomente

Durch zu hohe Anzugsmomente der Muttern können Näherungsschalter beschädigt werden.

Die maximal zulässigen Anzugsmomente beachten:

M12	10 Nm
M18	50 Nm
M30	150 Nm

Bündiger Einbau (b)

Bei bündigem Einbau bzw. bei Parallelmontage sind folgende Abstände einzuhalten:

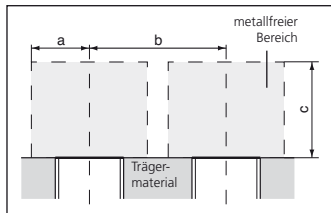

Bauform	Abstand [mm]		
	a	b	c
M12	8	20	8
M18	12	30	15
M30	20	45	30
DCC 12 MS	9	24	9
DCC 18 MS	14	36	15
DCC 30 MS	25	60	30
DCCR 40 KS	35	80	45

Nichtbündiger Einbau

Bei nicht bündigem Einbau bzw. bei Parallelmontage sind folgende Abstände einzuhalten:

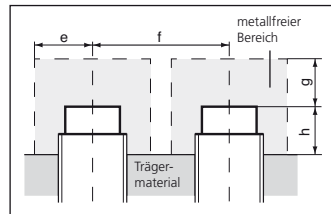

Bauform	Abstand [mm]			
	e	f	g	h
M12	10	25	13	5
M18	16	35	25	7
M30	30	65	35	10

Normmessplatten und Faktoren

Bedingt durch das neuartige Funktionsprinzip ist der erzielbare Schaltabstand abhängig von der Fläche und Dicke der Betätigungsfahne und von deren spezifischem Widerstand. Dadurch ergeben sich folgende Verhältnisse:

Bauform	Normmessplatte [mm]
M12 b	12 x 12 x 1
M12 nb	12 x 12 x 1
M18 b	18 x 18 x 1
M18 nb	24 x 24 x 1
M30 b	30 x 30 x 1
M30 nb	45 x 45 x 1

Installation notes ¹²

Maximum screw-in length

Due to the thread dimensions and tolerances stipulated in DIN 13, the following maximum screw-in lengths

are valid:	
M12	8 mm
M18	8 mm
M30	16 mm

Clearance drilling is required for longer threads.

Cable routing

To ensure a secure and reliable function, the following must be taken into account:

- Do not route the connection cables of the proximity switches together with higher voltage cables or with connection cables of higher inductive loads (contactors, valves, etc.) maintain safety distances.
- No peaks may occur in the power supply. Use a capacitor to buffer uncontrolled power supplies.

Tightening torque

Proximity switches can be damaged by an excessive tightening torque of the nuts. Please note the maximum permissible tightening torques:

M12	10 Nm
M18	50 Nm
M30	150 Nm

Flush mounting (b)

In case of flush mounting or parallel mounting the following distances should be observed:

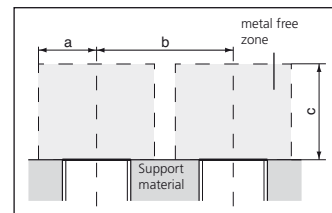

Design	Distance [mm]		
	a	b	c
M12	8	20	8
M18	12	30	15
M30	20	45	30
DCC 12 MS	9	24	9
DCC 18 MS	14	36	15
DCC 30 MS	25	60	30
DCCR 40 KS	35	80	45

Non-flush mounting (nb)

In case of non-flush mounting or parallel mounting the following distances should be observed:

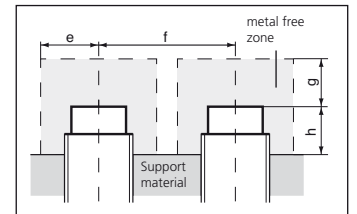

Design	Distance [mm]			
	e	f	g	h
M12	10	25	13	5
M18	16	35	25	7
M30	30	65	35	10

Standard measuring plates and factors

Due to the new operation principle the attainable operation distance depends on the square dimension and thickness of the actuation object and on its specific resistance. Thus the following conditions result:

Design	Meas. plate [mm]
M12 b	12 x 12 x 1
M12 nb	12 x 12 x 1
M18 b	18 x 18 x 1
M18 nb	24 x 24 x 1
M30 b	30 x 30 x 1
M30 nb	45 x 45 x 1

Reduktionsfaktor Reduction factor		Schaltabstand / Operating distance (mm)					
Materialeinfluss Messplatte Material influence meas. plate		M12 b	M12 nb	M18 b	M18 nb	M30 b	M30 nb
Stahl FE 360	Steel FE 360	1,00	1,00	1,00	1,00	1,00	1,00
Messing	Brass	1,40	1,30	1,00	1,30	1,00	1,10
Aluminium	Aluminium	1,00	1,00	1,00	1,00	1,00	1,00
Kupfer	Copper	0,60	0,90	0,90	0,90	0,90	0,90
Edelstahl (1 mm)	Stainless steel (1 mm)	–	0,40	0,30	0,40	0,40	0,60
Edelstahl (2 mm)	Stainless steel (2 mm)	0,60	0,70	0,80	0,80	0,70	0,70

Induktive Näherungsschalter | Inductive proximity switches

Einbauhinweise ¹³

Maximale Einschraublängen

Durch die in DIN 13 festgelegten Gewindedemaße und Toleranzen ergeben sich folgende maximale Einschraublängen:

M8 8 mm

Längere Gewinde sind entsprechend freizubohren.

Leitungsführung

Um eine sichere und zuverlässige Funktion zu gewährleisten, muss Folgendes beachtet werden:

- Anschlussleitungen der Näherungsschalter nicht zusammen mit Leitungen höherer Spannungen oder mit Anschlussleitungen hoher induktiver Lasten (Schütze, Ventile usw.) verlegen. Sicherheitsabstände einhalten.
- Auf der Versorgungsspannung dürfen keine Spannungsspitzen auftreten. Nicht geregelte Spannungsversorgungen mit einem Kondensator puffern.

Anzugsmomente

Durch zu hohe Anzugsmomente der Muttern können Näherungsschalter beschädigt werden.

Die maximal zulässigen Anzugsmomente beachten.

M8 4 Nm

Nichtbündiger Einbau (nb)

Bei nicht bündigem Einbau bzw. bei Parallelmontage sind folgende Abstände einzuhalten:

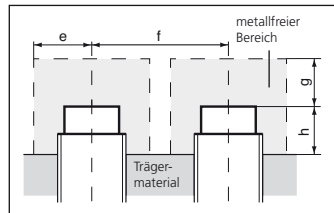

Bauform	Abstand [mm]			
	e	f	g	h
M8	15	24	12	5

Normmessplatten und Faktoren

Bauform Normmessplatte [mm]
M8 nb 12 x 12 x 1

Materialeinfluss Messplatte	Schaltabstand
Stahl FE 360	Sn x 1,00
Edelstahl V2A	Sn x 0,78
Messing	Sn x 0,58
Aluminium	Sn x 0,51
Kupfer	Sn x 0,49

Geometrieinfluss

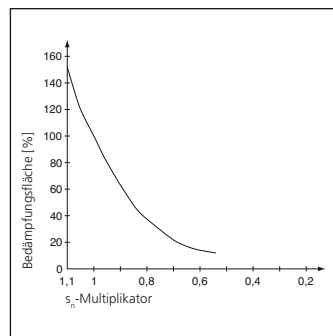

Bei Folien ist eine Verringerung des Schaltabstandes zu erwarten.

Installation notes ¹³

Maximum screw-in length

Due to the thread dimensions and tolerances stipulated in DIN 13, the following maximum screw-in lengths are valid:

M8 8 mm

Clearance drilling is required for longer threads.

Cable routing

To ensure a secure and reliable function, the following must be taken into account:

- Do not route the connection cables of the proximity switches together with higher voltage cables or with connection cables of higher inductive loads (contactors, valves, etc). maintain safety distances.
- No peaks may occur in the power supply. Use a capacitor so buffer uncontrolled power supplies.

Tightening torque

Proximity switches can be damaged by an excessive tightening torque of the nuts. Please note the maximum permissible tightening torques:

M8 4 Nm

Non-flush mounting (nb)

In case of non-flush mounting or parallel mounting the following distances should be observed:

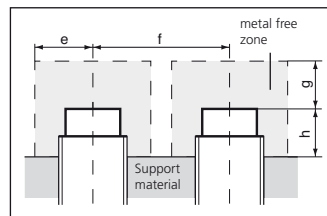

Design	Distance [mm]			
	e	f	g	h
M8	15	24	12	5

Standard measuring plates and factors

Design Measuring plate [mm]
M8 12 x 12 x 1

Material influence meas. plate	Operating distance
Stahl FE 360	Sn x 1,00
Stainless steel V2A	Sn x 0,78
Brass	Sn x 0,58
Aluminium	Sn x 0,51
Copper	Sn x 0,49

Geometric influence

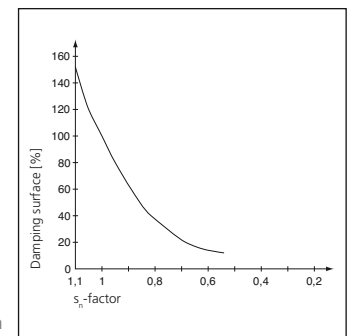

When using foils, a decrease in the usable operating distance can be expected.

Einbauhinweise ¹⁴

Maximale Einschraubängen

Durch die in DIN 13 festgelegten Gewindedemaße und Toleranzen ergeben sich folgende maximale Einschraubängen:

M8 8mm
Längere Gewinde sind entsprechend freizubohren.

Leitungsführung

Um eine sichere und zuverlässige Funktion zu gewährleisten, muss Folgendes beachtet werden:

- Anschlussleitungen der Näherungsschalter nicht zusammen mit Leitungen höherer Spannungen oder mit Anschlussleitungen hoher induktiver Lasten (Schütze, Ventile usw.) verlegen. Sicherheitsabstände einhalten.
- Auf der Versorgungsspannung dürfen keine Spannungsspitzen auftreten. Nicht geregelte Spannungsversorgungen mit einem Kondensator puffern.

Anzugsmomente

Durch zu hohe Anzugsmomente der Muttern können Näherungsschalter beschädigt werden.

Die maximal zulässigen Anzugsmomente beachten:

M8 10 Nm

Quasi bündiger Einbau (qb)

Bei quasi bündigem Einbau bzw. bei Parallelmontage sind folgende Abstände einzuhalten:

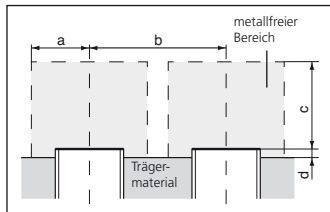

Abstand [mm]	Bauform	
	Ø 6,5	M8
a	10	12
b	20	24
c	6	6
d (ferromagn. Mat.)	0,7	0,7
d (andere Materialien)	0	0

Installation notes ¹⁴

Maximum screw-in length

Due to the thread dimensions and tolerances stipulated in DIN 13, the following maximum screw-in lengths are valid:

M8 8mm
Clearance drilling is required for longer threads.

Cable routing

To ensure a secure and reliable function, the following must be taken into account:

- Do not route the connection cables of the proximity switches together with higher voltage cables or with connection cables of higher inductive loads (contactors, valves, etc). maintain safety distances.
- No peaks may occur in the power supply. Use a capacitor to buffer uncontrolled power supplies.

Tightening torque

Proximity switches can be damaged by an excessive tightening torque of the nuts. Please note the maximum permissible tightening torques:

M8 10 Nm

Quasi-flush mounting (qb)

In case of quasi-flush mounting or parallel mounting the following distances should be observed:

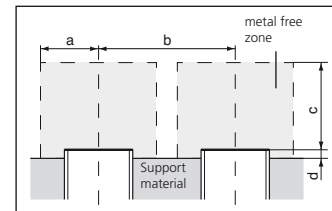

Distance [mm]	Design	
	Ø 6,5	M8
a	10	12
b	20	24
c	6	6
d (ferromagn. Mat.)	0,7	0,7
d (other material)	0	0

Standard measuring plates and factors

Design	Measuring plate [mm]	Operating distance
Ø 6,5 qb	6,5x6,5x1	Sn x 1,00
M8 qb	8x8x1	Sn x 0,67
Material influence meas. plate		
Steel FE 360		Sn x 0,65
Stainless steel V2A		Sn x 0,42
Edelstahl V4A		Sn x 0,32
Brass		Sn x 0,23
Aluminium		
Copper		

Induktive Näherungsschalter | Inductive proximity switches

Einbauhinweise ¹⁵

Maximale Einschraub­längen

Durch die in DIN 13 festgelegten Gewin­demaße und Toleranzen ergeben sich folgende maximale Einschraub­längen:

M8	8 mm
M12	8 mm
M18	8 mm
M30	16 mm
M50	20 mm

Längere Gewinde sind entsprechend freizubohren.

Leitungsführung

Um eine sichere und zuverlässige Funktion zu gewährleisten, muss Folgendes beachtet werden:

- Anschlussleitungen der Näherungsschalter nicht zusammen mit Leitungen höherer Spannungen oder mit Anschlussleitungen hoher induktiver Lasten (Schütze, Ventile usw.) verlegen. Sicherheitsabstände einhalten.
- Auf der Versorgungsspannung dürfen keine Spannungsspitzen auftreten. Nicht geregelte Spannungsversorgungen mit einem Kondensator puffern.

Anzugsmomente

Durch zu hohe Anzugsmomente der Muttern können Näherungsschalter beschädigt werden.

Die maximal zulässigen Anzugsmomente beachten:

M8	10 Nm
M12	20 Nm
M18	50 Nm
M30	150 Nm
M50	100 Nm

Bündiger Einbau (b)

Bei bündigem Einbau bzw. bei Parallelmontage sind folgende Abstände einzuhalten:

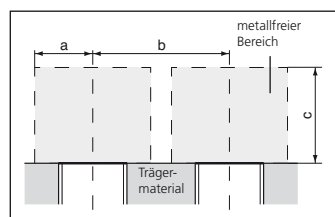

Bauform	Abstand [mm]		
	a	b	c
M8	6	10	65
M12	9	20	9
M18	14	30	15
M30	25	60	30

Nichtbündiger Einbau (nb)

Bei nicht bündigem Einbau bzw. bei Parallelmontage sind folgende Abstände einzuhalten:

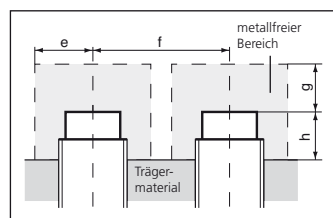

Bauform	Abstand [mm]			
	e	f	g	h
M18	20	50	15	15
M30	40	80	20	20
M50	100	150	30	30

Quasi bündiger Einbau (qb)

Bei quasi bündigem Einbau bzw. bei Parallelmontage sind folgende Abstände einzuhalten:

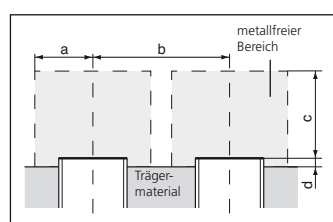

Bauform	Abstand [mm]			
	a	b	c	d
M50	50	150	60	10

Normmessplatten und Faktoren

Bauform	Normmessplatte [mm]
M8	8x8x1
M12	12x12x1
M18 b	18x18x1
M18 nb	24x24x1
M30 b	30x30x1
M30 nb	45x45x1
M50 qb	60x60x1
M50 nb	75x75x1

Installation notes ¹⁵

Maximum screw-in length

Due to the thread dimensions and tolerances stipulated in DIN 13, the following maximum screw-in lengths are valid:

M8	8 mm
M12	8 mm
M18	8 mm
M30	16 mm
M50	20 mm

Clearance drilling is required for longer threads.

Cable routing

To ensure a secure and reliable function, the following must be taken into account:

- Do not route the connection cables of the proximity switches together with higher voltage cables or with connection cables of higher inductive loads (contactors, valves, etc.) maintain safety distances.
- No peaks may occur in the power supply. Use a capacitor to buffer uncontrolled power supplies.

Tightening torque

Proximity switches can be damaged by an excessive tightening torque of the nuts. Please note the maximum permissible tightening torques:

M8	10 Nm
M12	20 Nm
M18	50 Nm
M30	150 Nm
M50	100 Nm

Flush mounting (b)

In case of flush mounting or parallel mounting the following distances should be observed:

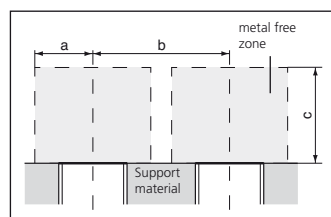

Design	Distance [mm]		
	a	b	c
M8	6	10	65
M12	9	20	9
M18	14	30	15
M30	25	60	30

Non-flush mounting (nb)

In case of non-flush mounting or parallel mounting the following distances should be observed:

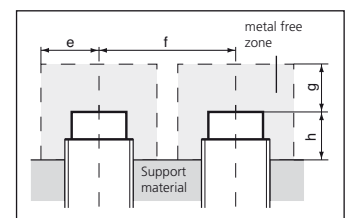

Design	Distance [mm]			
	e	f	g	h
M18	20	50	15	15
M30	40	80	20	20
M50	100	150	30	30

Quasi-flush mounting (qb)

In case of quasi-flush mounting or parallel mounting the following distances should be observed:

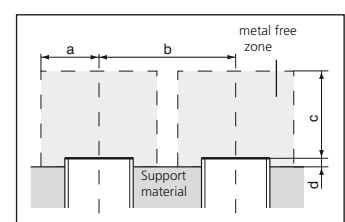

Design	Distance [mm]			
	a	b	c	d
M50	50	150	60	10

Standard meas. plates and factors

Design	Measuring plate [mm]
M8	8x8x1
M12	12x12x1
M18 b	18x18x1
M18 nb	24x24x1
M30 b	30x30x1
M30 nb	45x45x1
M50 qb	60x60x1
M50 nb	75x75x1

Reduktionsfaktor Reduction factor		Schaltabstand / Operating distance (mm)							
Materialeinfluss Messplatte Material influence meas. plate		M8 b	M12 b	M18 b	M18 nb	M30 b	M30 nb	M50 qb	M50 nb
Stahl FE 360 Steel FE 360		1,00	1,00	1,00	1,00	1,00	1,00	1,00	1,00
Messing Brass		0,25	0,15	0,35	0,35	0,50	0,50	0,50	0,50
Aluminium Aluminium		–	0,20	0,25	0,25	0,35	0,35	0,35	0,35
Kupfer Copper		–	0,15	0,20	0,20	0,30	0,30	0,30	0,30
Edelstahl Stainless steel		0,60	0,65	0,70	0,70	0,70	0,70	0,70	0,70

Einbauhinweise ¹⁶

Maximale Einschraubängen

Durch die in DIN 13 festgelegten Gewindedemaße und Toleranzen ergeben sich folgende maximale Einschraubängen:

M12	8 mm
M18	8 mm
M30	16 mm

Längere Gewinde sind entsprechend freizubohren.

Leitungsführung

Um eine sichere und zuverlässige Funktion zu gewährleisten, muss Folgendes beachtet werden:

- Anschlussleitungen der Näherungsschalter nicht zusammen mit Leitungen höherer Spannungen oder mit Anschlussleitungen hoher induktiver Lasten (Schütze, Ventile usw.) verlegen. Sicherheitsabstände einhalten.
- Auf der Versorgungsspannung dürfen keine Spannungsspitzen auftreten. Nicht geregelte Spannungsversorgungen mit einem Kondensator puffern.

Anzugsmomente

Durch zu hohe Anzugsmomente der Muttern können Näherungsschalter beschädigt werden.

Die maximal zulässigen Anzugsmomente beachten:

M12	20 Nm
M18	50 Nm
M30	150 Nm

Bündiger Einbau (b)

Bei bündigem Einbau bzw. bei Parallelmontage sind folgende Abstände einzuhalten.

Nichtbündiger Einbau (nb)

Bei nicht bündigem Einbau bzw. bei Parallelmontage sind folgende Abstände einzuhalten:

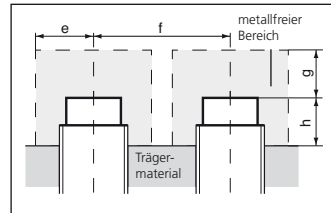

Abstand [mm]	Bauform		
	M12	M18	M30
e	30	50	90
f	105	200	250
g	30	60	120
h (Aluminium)	13	20	30
h (Messing)	15	22	40
h (Stahl)	23	34	60
h (Edelstahl)	21	36	60

Normmessplatten und Faktoren

Bedingt durch das neuartige Funktionsprinzip ist der erzielbare Schaltabstand abhängig von der Fläche und Dicke der Betätigungsfahne und von deren spezifischem Widerstand. Dadurch ergeben sich folgende Verhältnisse:

Bauform	Normmessplatte [mm]
M12 b	18x18x1
M12 nb	30x30x1
M18 b	30x30x1
M18 nb	60x60x1
M30 b	60x60x1
M30 nb	120x120x1

Installation notes ¹⁶

Maximum screw-in length

Due to the thread dimensions and tolerances stipulated in DIN 13, the following maximum screw-in lengths

are valid:

M12	8 mm
M18	8 mm
M30	16 mm

Clearance drilling is required for longer threads.

Cable routing

To ensure a secure and reliable function, the following must be taken into account:

- Do not route the connection cables of the proximity switches together with higher voltage cables or with connection cables of higher inductive loads (contactors, valves, etc.) maintain safety distances.
- No peaks may occur in the power supply. Use a capacitor to buffer uncontrolled power supplies.

Non-flush mounting (nb)

In case of non-flush mounting or parallel mounting the following distances should be observed:

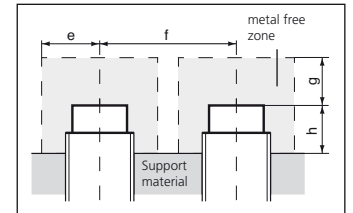

Distance [mm]	Design		
	M12	M18	M30
e	30	50	90
f	105	200	250
g	30	60	120
h (aluminium)	13	20	30
h (brass)	15	22	40
h (steel)	23	34	60
h (stainless steel)	21	36	60

Standard measuring plates and factors

Due to the new operation principle the attainable operation distance depends on the square dimension and thickness of the actuation object and on its specific resistance. Thus the following conditions result:

Design	Meas. plate [mm]
M12 b	18x18x1
M12 nb	30x30x1
M18 b	30x30x1
M18 nb	60x60x1
M30 b	60x60x1
M30 nb	120x120x1

Tightening torque

Proximity switches can be damaged by an excessive tightening torque of the nuts. Please note the maximum permissible tightening torques:

M12	20 Nm
M18	50 Nm
M30	150 Nm

Flush mounting (b)

In case of flush mounting or parallel mounting the following distances should be observed:

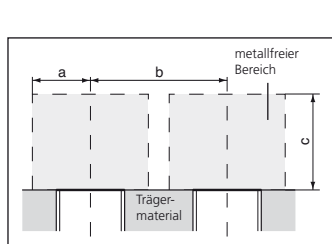

Bauform	Abstand [mm]		
	a	b	c
M12	12	50	18
M18	25	60	30
M30	45	120	60

Geometrieinfluss

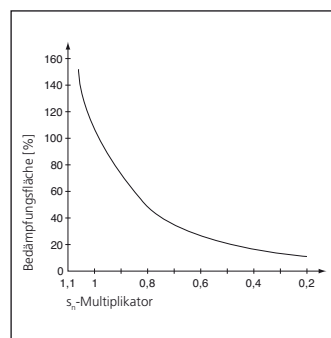

Bei Folien ist eine Verringerung des Schaltabstandes zu erwarten.

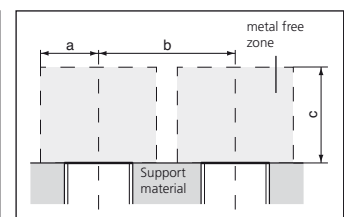

Design	Distance [mm]		
	a	b	c
M12	12	50	18
M18	25	60	30
M30	45	120	60

Geometric influence

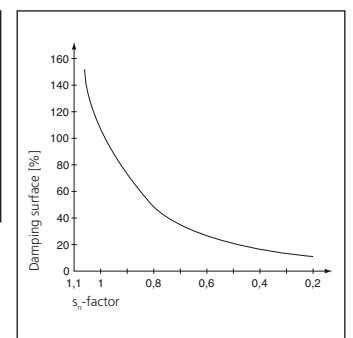

When using foils, a decrease in the usable operating distance can be expected.

Reduktionsfaktor Reduction factor		Schaltabstand / Operating distance (mm)					
Materialeinfluss Messplatte Material influence meas. plate		M12 b	M12 nb	M18 b	M18 nb	M30 b	M30 nb
Stahl FE 360	Steel FE 360	1,00	1,00	1,00	1,00	1,00	1,00
Messing	Brass	1,30	1,35	1,20	1,35	1,20	1,20
Aluminium	Aluminium	1,00	1,00	1,00	1,00	1,00	1,00
Kupfer	Copper	0,85	0,80	0,80	0,90	0,90	0,85
Edelstahl (1 mm)	Stainless steel (1 mm)	0,50	0,10	0,50	0,30	0,50	—
Edelstahl (2 mm)	Stainless steel (2 mm)	0,90	0,70	0,90	0,60	0,90	0,50

Kapazitive Näherungsschalter | Capacitive proximity switches

Begriffserklärungen

Funktion

Mit kapazitiven Näherungsschaltern können Objekte aus leitenden Materialien (Metalle) und nichtleitenden Materialien (Nichtmetalle) erfasst werden. Die Permittivitätszahl (ϵ_r) der zu erkennenden Objekte muss dabei wesentlich größer als die der Luft ($\epsilon_r = 1$) sein.

Bündiger Einbau

Diese Näherungsschalter können in alle Materialien (Metalle/Nichtmetalle) so eingebaut werden, dass die aktive Sensorfläche frontseitig bündig mit dem umgebenden Material abschließt. Sie besitzen folgende Vorteile:

- Bündiger Einbau in leitende Materialien (Metalle).
- Schutz der aktiven Fläche vor mechanischen Beschädigungen.
- Geringerer Einfluss äußerer Störfelder.
- Geringerer seitlicher Abstand zum nächsten Näherungsschalter.

Nichtbündiger Einbau

Diese Näherungsschalter dürfen in alle Materialien (Metalle/Nichtmetalle) nicht bündig eingebaut werden. Sie besitzen den größtmöglichen Schaltabstand. Für diese Näherungsschalter gelten besondere Einbauvorschriften.

Schaltabstand

Der Schaltabstand S_n wird mit einer sich in axialer Richtung annähernden quadratischen Messplatte (St37, geerdet) bestimmt. Die Kantenlänge der Messplatte muss dem Durchmesser der aktiven Fläche entsprechen. Der Schaltabstand S_n ist der Abstand, bei dem die Messplatte einen Signalwechsel am Ausgang des Näherungsschalters hervorruft. Der Schaltabstand ist abhängig von der Permittivitätszahl (ϵ_r) des zu erkennenden Objekts und der Größe der aktiven Sensorfläche.

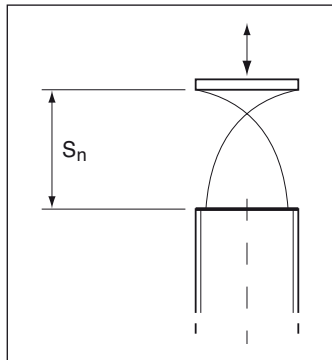

Erfassbare Objekte

Bei Objekten aus leitenden Materialien (Metallen) ergibt sich der größte Schaltabstand. Der Schaltabstand ist dabei unabhängig von der Dicke und der Leitfähigkeit des Materials. Die Größe der Fläche des Objektes beeinflusst den Schaltabstand.

Der Schaltabstand von Objekten aus nichtleitenden Materialien (Nichtmetalle) ist abhängig von der Permittivitätszahl (ϵ_r). Objekte aus Materialien mit hoher Permittivitätszahl (ϵ_r) haben höhere Schaltabstände.

Objekte mit höherer Permittivitätszahl (ϵ_r) lassen sich durch Objekte mit niedrigerer Permittivitätszahl (ϵ_r) hindurch erkennen (z.B. Flüssigkeiten in Glasbehältern).

Reduktionsfaktor

Der angegebene Schaltabstand S_n ist auf eine quadratische Messplatte (St37, geerdet) bezogen.

Objekte aus leitenden Materialien (Metalle), die nicht geerdet sind, haben nur ca. 80% des Schaltabstandes.

Dieser Korrekturfaktor ist ein Anhaltswert.

npn-Ausgang

Die Last wird zwischen positiver Versorgungsspannung und dem Ausgang des Näherungsschalters angeschlossen. Der npn-Transistor des Näherungsschalters schaltet die Last gegen 0 Volt.

pnp-Ausgang

Die Last wird zwischen dem Ausgang des Näherungsschalters und 0 Volt angeschlossen. Der pnp-Transistor des Näherungsschalters schaltet die Last gegen die positive Versorgungsspannung.

Schließer, NO

Im Normalzustand (kein Objekt vor der aktiven Sensorfläche) ist der Ausgangstransistor gesperrt (ausgeschaltet). Befindet sich ein Objekt innerhalb des Schaltabstandes vor der aktiven Sensorfläche, ist der Ausgangstransistor leitend (eingeschaltet).

Öffner, NC

Im Normalzustand (kein Objekt vor der aktiven Sensorfläche) ist der Ausgangstransistor leitend (eingeschaltet). Befindet sich ein Objekt innerhalb des Schaltabstandes vor der aktiven Fläche, ist der Ausgangstransistor gesperrt (ausgeschaltet).

Explanations

Function

Capacitive proximity switches are used for detecting objects that consist of conductive (metallic) and non-conductive (non-metallic) materials. The dielectric constant (ϵ_r) of the material to be detected must be considerably greater than of air ($\epsilon_r = 1$).

Flush mounting

These proximity switches can be fitted in all materials (metallic/non-metallic), so that the sensing face is flush with the front of the surrounding material. They have following advantages:

- Flush installation in conductive materials (metals).
- Protection of the sensing face from mechanical damage.
- Lower influence of external interference fields.
- Lower lateral distance to the next proximity switch.

Non-flush mounting

These proximity switches must not be flush-fitted with the surface of all materials (metallic/non-metallic). They have the greatest possible operating distance. Special installation notes are applicable to these proximity switches.

Operating distance

The operating distance S_n is determined with a square measuring plate (St 37 / grounded) approaching in axial direction. The edge length of the measuring plate must be equivalent to the diameter of the sensing face.

The operating distance S_n is the distance at which the measuring plate causes a signal change at the output of the proximity switch.

The operating distance is dependent on the dielectric constant (ϵ_r) of the object to be detected and the size of the sensing face.

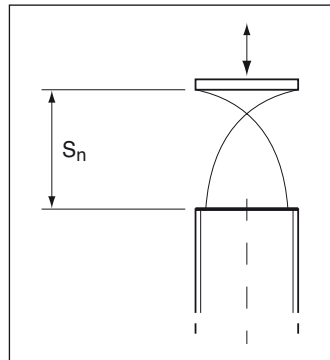

Detectable objects

The greatest operating distance is obtained with objects that consist of conductive (metallic) materials. The operating distance for these is independent of the thickness and the conductivity of the material. The surface size of the object affects the operating distance. The operating distance of objects that consist of non-conductive (non-metallic) materials is dependent on the dielectric constant (ϵ_r). Objects consisting of materials with a high dielectric constant (ϵ_r) have higher operating distances.

Objects with a higher dielectric constant (ϵ_r) can be detected through objects with a lower dielectric constant (ϵ_r) (e.g. fluids in glass containers).

Reduction factor

The indicated operating distance S_n refers to a square measuring plate (St 37, grounded).

Objects of conductive materials (metals), which are not grounded, only have about 80% of the operating distance. This correction factor is provided for guidance only.

npn-output

The load is connected between the positive supply voltage and the output of the proximity switch.

The npn transistor of the proximity switch connects the load to 0 Volt.

pnp-output

The load is connected between the output of the proximity switch and 0 Volt. The pnp transistor of the proximity switch connects the load to the positive supply voltage.

NO contact (normally open)

In the normal condition (no object in front of the sensing face), the output transistor is inhibited (switched off). If an object is located within the operating distance in front of the sensing face, the output transistor is conductive (switched on).

NC contact (normally closed)

In the normal condition (no object in front of the sensing face), the output transistor is conductive (switched on). If an object is located within the operating distance in front of the sensing face, the output transistor is inhibited (switched off).

Einbauhinweise ¹⁰

Leitungsführung

Um eine sichere und zuverlässige Funktion zu gewährleisten, muss Folgendes beachtet werden:

- Anschlussleitungen der Näherungsschalter nicht zusammen mit Leitungen höherer Spannungen oder mit Anschlussleitungen hoher induktiver Lasten (Schütze, Ventile usw.) verlegen. Sicherheitsabstände einhalten.
- Auf der Versorgungsspannung dürfen keine Spannungsspitzen auftreten. Nicht geregelte Spannungsversorgungen mit einem Kondensator puffern.

Anzugsmomente

Durch zu hohe Anzugsmomente der Muttern können Näherungsschalter beschädigt werden.

Die maximal zulässigen Anzugsmomente (für Metall) beachten.

M8x1	15 Nm
M12x1	10 Nm
M18x1	25 Nm
M30x1,5	65 Nm

Nichtbündiger Einbau

Bei Näherungsschaltern, die in alle Materialien (Metalle/Nichtmetalle) nicht bündig eingebaut werden dürfen, müssen folgende Mindestabstände eingehalten werden.

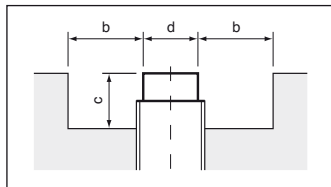

- Ⓐ $b = d, c = 2 S_n$
- Ⓑ $b = 0,5 d, c = 3 \text{ mm}$

Anreihung

Um eine gegenseitige Beeinflussung zu vermeiden, muss zwischen den Näherungsschaltern ein Mindestabstand a eingehalten werden.

$a = d$

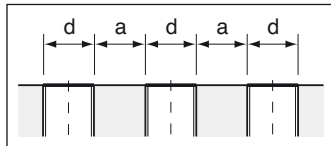

Gegenüberliegende Sensoren

Bei sich gegenüberliegenden Sensoren muss der Abstand zwischen den aktiven Flächen mindestens $4d$ bzw. $4 \times$ den Nennschaltabstand ($4 S_n$), je nachdem welcher Wert größer ist, betragen.

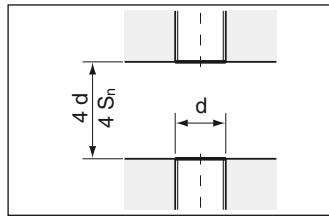

Maximale Einschraubängen

Durch die in DIN 13 festgelegten Gewindemaße und Toleranzen ergeben sich folgende maximale Einschraubängen:

M8	8 mm
M12	8 mm
M18	8 mm
M30	16 mm

Längere Gewinde sind entsprechend freizubohren.

Justage

Der Schaltabstand kann mit einem Potentiometer in bestimmten Grenzen eingestellt werden. Dadurch kann der Schaltabstand an die jeweilige Anwendung angepasst werden.

Standardmäßig sind die kapazitiven Näherungsschalter auf den Nennschaltabstand S_n eingestellt.

Justage Bauform 34x16x8 mm

Potentiometer und LED befinden sich unter einer Klappe an der kurzen Stirnseite des Sensors, gegenüber dem Anschlusskabel. Zur Justage die Klappe mit einem kleinen Schraubenzieher öffnen.

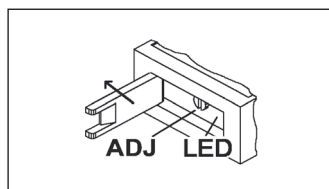

Selbstanpassende Sensoren

Selbstanpassende Sensoren sind für Standardanwendungen mit wasserartigen Medien ab Werk vorjustiert. Die Sensoren eignen sich ohne weitere Einstellung zur Erfassung von wasserartigen Medien durch Glas- oder Kunststoffwandungen hindurch. Die Wandungen (ca. 0,5... 6 mm) werden automatisch ausgeblendet. Schaum, Feuchtigkeit und Schmutzanhäufungen innen und außen am Behälter werden in weiten Grenzen kompensiert.

Installation notes ¹⁰

Cable routing

To ensure a secure and reliable function, the following must be taken into account:

- Do not route the connection cables of the proximity switches together with higher voltage cables or with connection cables of higher inductive loads (contactors, valves, etc.) maintain safety distances.
- No peaks may occur in the power supply. Use a capacitor to buffer uncontrolled power supplies.

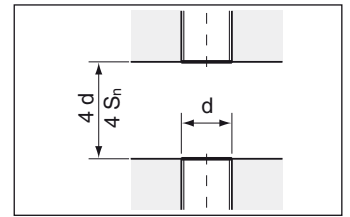

Maximum screw-in length

Due to the thread dimensions and tolerances stipulated in DIN 13, the following maximum screw-in lengths are valid:

M8	8 mm
M12	8 mm
M18	8 mm
M30	16 mm

Clearance drilling is required for longer threads.

Trimming

The operating distance can be set within specific limits with a potentiometer.

Therefore, the operating distance can be adapted to each application. The capacitive proximity switches are set as standard to the nominal operating distance S_n .

Tightening torque

Proximity switches can be damaged by an excessive tightening torque of the nuts. Please note the maximum permissible tightening torques (for metal).

M8x1	15 Nm
M12x1	10 Nm
M18x	25 Nm
M30x1,5	65 Nm

Non-flush mounting

The following minimum distances must be maintained for proximity switches that may not be mounted flush in any material (metallic/non-metallic).

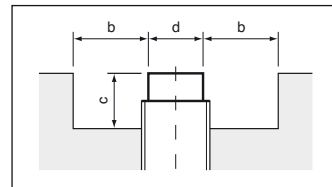

- Ⓐ $b = d, c = 2 S_n$
- Ⓑ $b = 0,5 d, c = 3 \text{ mm}$

Mounting side by side

To avoid mutual interaction, a minimum distance a must be maintained between the proximity switches.

$a = d$

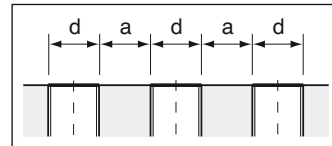

Opposite sensors

For sensors positioned opposite one another the distance between the active zones must be at least $4d$ or $4 \times$ the nominal sensing distance ($4 S_n$), whichever value is greater.

Adjustment model 34x16x8 mm

The potentiometer and LED are located under the cover on the front side of the sensor, opposite the connection cable. Open the cover with a small screwdriver

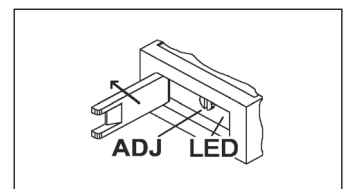

to adjust.

Self-adapting sensors

Self-adapting sensors are pre-adjusted by factory technicians for standard applications with aqueous media. The sensors are fully tuned to detect aqueous media through glass or plastic surfaces without further adjustment. Glass or plastic container surfaces (approx. 0.5 to 6 mm) are automatically ignored. Foam, moisture and dirt adhering to the inside and outside of the container surface are also taken into consideration and compensated for.

GERMANY

di-soric GmbH & Co. KG
Steinbeisstraße 6
73660 Urbach

Germany

Fon: +49(0)71 81/98 79-0

Fax: +49(0)71 81/98 79-179

info@di-soric.com

Niederlassungen Subsidiaries

AUSTRIA

di-soric Austria GmbH & Co. KG
Burg 39
4531 Kematen an der Krems

Austria

Fon: +43(0)72 28/72 366

Fax: +43(0)72 28/72 405

info.at@di-soric.com

FRANCE

di-soric SAS
19, Chemin du Vieux Chêne
38240 Meylan

France

Fon: +33(0)4 76 61/65 90

Fax: +33(0)4 76 61/65 98

info.fr@di-soric.com

SINGAPORE

di-soric Pte. Ltd.
119 Verde Crescent
Singapore 688459

Singapore

Fon: +65/65 23 80 65

Fax: +65/65 23 80 67

info.sg@di-soric.com

